



PRICE GUIDE JANUARY 2024

MATERIALS & FINISHES

Selecting Product Finishes

When specifying a product, please make note of all finish choices underneath the model number (or applicable options with finishes, such as arm caps). See product pages for material availability on each product series.

Urethane Finishes



Black



Carbon



Taupe



Titanium

Solid Surface Finishes*

Group 1



Antarctica
from Corian®

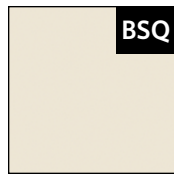

Bisque
from Corian®

Group 2

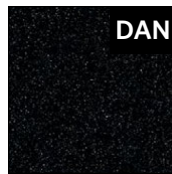

Deep Anthracite
from Corian®



Deep Cloud
from Corian®

***Note**

Additional metal & solid surface finishes are available. Please contact customer service for a quote.

Metal Finishes*

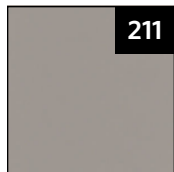

Silver Frost

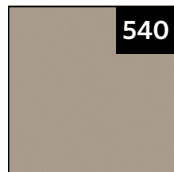

Pewter

Thermofoil Finishes

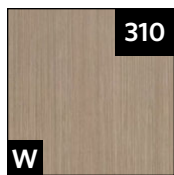

Aria

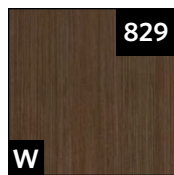

Baroque

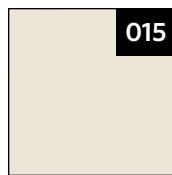

Bisque

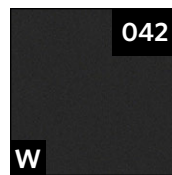

Black

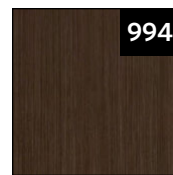

Coffee

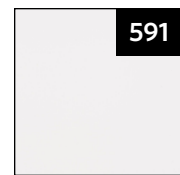

Crystal White

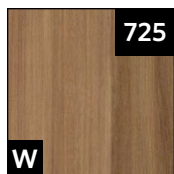

Elm

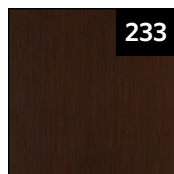

Espresso

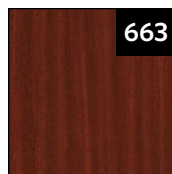

Mahogany

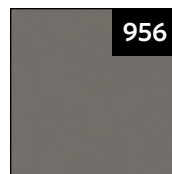

Matte Stone



Medium Maple

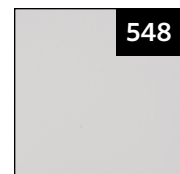

Northern Grey

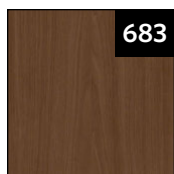

Walnut

Wood Leg Finishes

W Finishes marked with this symbol are also available as a wood finish (applicable on wood legs and feet).

CONTENTS

REFERENCE

Finishes	2
Contents	3
Orders & Shipping	4
Service	5
Warranty	6
GSA	7
GPO Contracts	8
CAL	9
UL Takeback Program	9
Certifications	10
Moisture Barriers	11
COM	11



PRODUCTS

Public Area Seating	16	Recliners	84
Visitor		350 Series	86
Kadia Mod Metal Visitor	17	450 Series	102
Koncert Metal Visitor	26	Durable® Series Recliners	106
Koncert Kadia Occasional Tables	33	Durable® 550 Series	111
Koncert Kadia Hip Chair	34	Durable® 650 Series	118
Metal Lounge		Durable® 750 Series	136
Kadia Mod Metal Lounge	37	Durable® Power Series	145
Koncert Metal Lounge	43	Durable® Exam Lift Series	152
Upholstered Lounge		Sleep Series	159
Kadia Mod Upholstered Lounge	48	Sleep Chairs	160
Koncert Upholstered Lounge	54	Sofa & Bench	
Dalton Lounge	60	Oxley Sleep Sofa	165
Assymble Modular Lounge	62	Oxley Sleep Bench	167
Kascade Lounge	72	Max Sleep Sofa	168
Koncert Behavioral Health	79		

ORDER INFORMATION

Purchasing

All prices shown in this price book are list prices in US Dollars. Prices are subject to change without notice. The customer's purchase order must include complete information or order will be held from production until all information is provided. The customer bears sole responsibility for order correctness. Orders are subject to Knú, LLC's terms and conditions, regardless of the terms and conditions set forth on the buyer's/customer's purchase order forms. All customer orders must receive credit approval before the order can be entered into production.

Mail, Fax, or E-mail Purchase Orders To
Knú, LLC DBA La-Z-Boy Healthcare | Knú Comfort
P.O. Box 9, Ferdinand, IN 47532
Phone: 812.367.2068 | Fax: 812.367.2493
E-mail: orders@getknu.com

Payment Terms

Terms are NET 30 days from shipment. If an invoice is not paid in full, within the terms, a monthly finance charge will be assessed at a rate of 1.5% per month or the highest amount permitted by applicable state law. The customer will be liable for any collection and/or attorney fees incurred in the collection of past due accounts.

Selling Information

Distribution of this price list does not in itself constitute an offer to sell. Orders may only be placed by customers authorized by Knú, LLC management.

Order Acknowledgment

The customer will receive an order acknowledgement by e-mail or fax. Upon receipt of this acknowledgement it is the customer's responsibility to check the accuracy of the order and notify customer service of any errors. Once an order is acknowledged, Knú, LLC will be responsible for shipping exactly the items acknowledged at the prices acknowledged. No changes may be made once an order has been placed into production. The order will be shipped upon completion of production. Every effort will be made to ship orders within the acknowledged ship dates. Acknowledged ship dates, however, are contingent upon conditions beyond our control. We cannot make promises for delivery dates as service by transportation companies varies from destination to destination.

Order Cancellations

Cancellations must be communicated via email or fax to customer service and not to the sales representative. A cancellation penalty will apply. After an order is acknowledged and placed into production, cancellations cannot be accepted.

SHIPPING

Packaging

All prices include packaging. Assembled chairs are normally shipped one per carton unless otherwise specified. All of our packaging and cartons meet or exceed ICC specifications.

Freight Terms & Conditions

All product is shipped F.O.B. the Knú, LLC factory, with freight prepaid to the continental U.S. destination (dealer's dock or territorial warehouse) and does not include home delivery. International shipments, shipments to Puerto Rico, Hawaii, and Alaska are freight prepaid to the port of exit. For special packing for these shipments, call Customer Service for quote. Customers must select a standard delivery location for their orders. Docks at the selected delivery location must be equipped to handle a 53' trailer. When a Knú, LLC customer/dealer warehouse is selected as the default delivery location, it is understood that Knú, LLC pays freight cost to the default delivery location only, and no further. The customer is responsible for all charges from this point. Knú, LLC utilizes freight carriers that are dedicated furniture specialists. For all deliveries, it is understood that Knú, LLC or its agents are making a dock delivery only, and any further work of truck unloading, delivery beyond the dock, installation, and/or removal of packaging is not authorized or paid for by Knú, LLC. Home delivery is not included and must be negotiated prior to order placement. For all deliveries, whether to the customer location or drop shipment, any circumstances that result in the delay of our carrier (including unsuitable receiving facilities, or facilities not open or available), will result in service charges applied at the rate of \$75 per hour. Where re-delivery is necessary because of these circumstances, the full cost of re-delivery will be charged.

International shipments, shipments into Puerto Rico, and shipments into the states of Hawaii and Alaska are freight prepaid to the port of exit. Please call Customer Service for a quote on special packing for overseas container shipments. Knú, LLC reserves the right to implement a fuel surcharge or freight fee and also reserves the right to select the most appropriate F.O.B. point, carrier, and routing on all shipments. Orders with a LIST total of \$4,000 or less are subject to a \$250 Shipping and Handling Fee. All Knú, LLC products are carefully inspected and properly packaged by trained personnel before leaving the factory. The transportation company assumes full responsibility for safe delivery upon acceptance of the shipment. All shipments are delivered to the freight company in good condition. If a shipment is received that has visible damage,

product shortages or if delivery has been delayed by the freight company the following steps must be taken:

1. Before signing for the merchandise, make notations of all visible damage and/or shortages on the Bill of Lading. The delivering freight company may not accept responsibility for damage and/or shortages if proper notification of the alleged problem is not given when signing for the merchandise. If visual damage is not apparent, sign the delivery receipt "no visual damage". This will allow recourse for a concealed damage claim. Claims for freight damage, concealed or otherwise, must be filed within ten (10) days of the original delivery date.
2. Do not refuse merchandise damaged in transit. The delivering freight company (not Knú, LLC) is responsible for damage to goods which occur in transit or storage.
3. Failure to make claims against Knú, LLC or its designated carrier within ten (10) days shall constitute acceptance of the merchandise and a waiver of any defects, errors, or shortages discovered upon inspection.
4. If a claim is filed you must retain all shipping cartons and packing material for inspection by the carrier agent.

Freight Policy

As of July 15, 2022, a freight fee will be effective on standard productions orders in the amount of 2% of the List total.

Storage Policy

Upon written notice, Knú | La-Z-Boy will provide storage, once an order is completed, for up to five (5) calendar days at no charge. Any order requiring storage beyond five (5) calendar days will be subject to a storage fee.

SERVICE

Return Merchandise

No returns of merchandise will be accepted without written authorization from Knú corporate office customer service. Before a return of merchandise is authorized, Knú factory sales representative reserves the right to inspect the furniture in question. Any item(s) that has been approved for return must be returned properly packed and in the original factory carton. All freight charges for returned product are the responsibility of the customer. Unauthorized returns will not be accepted and will be returned to customer freight collect. Upon receipt, all returned merchandise will be thoroughly inspected and the results compared to the reason given for the return stated on the authorization form. Any discrepancies, such as additional damage, signs of usage, missing parts, etc., will result in an adjustment to the amount of the credit issued.

Customer Satisfaction

Our goal at Knú, LLC is to ensure that our customers are completely satisfied with our products. If a problem arises with La-Z-Boy Healthcare | Knú Comfort after the warranty period, Knú, LLC will make its best effort to satisfy the customer in a manner that is fair to all concerned.

IMPORTANT NOTES

1. COM orders must contain the fabric supplier name, pattern name, and color name of the pattern you wish to order.
2. Directional covers, such as stripes, patterns, and plaids may not meet your satisfaction due to contoured shapes and tufting on some furniture styles. Should one of these designs be selected, we will do our best to manufacture the furniture to meet your satisfaction. However, such orders are not subject to return.
3. Textiles listed are supplied by the fabric suppliers and not all colors of the textile listed may be available.
4. Once an order for cut yardage is acknowledged, adjustments or cancellations will result in a restocking fee for the purchase price of the fabric.
5. Not all textiles are available in CAL 133.
6. Non-Warranty Service Orders: Please Call Customer Service for Pricing. (812.367.2068/phone)

LIMITED LIFETIME WARRANTY

Knú, LLC dba La-Z-Boy Healthcare | Knú Comfort warrants the products it manufactures against defects in material and workmanship under normal use and service for the expected useful life of the product from the date of shipment. This limited warranty is valid only to the original purchaser using the product for its intended purpose, provided the product is covered in its original cover. This warranty does not apply to expected changes resulting from normal wear and tear, use and aging of the product. Specifically excluded from this limited warranty are defects and damage resulting from abuse, neglect, misuse, or excessive use. Product alteration, substitution of components or materials, improper cleaning or repair, and installation and handling damages are also not covered by this warranty. All other express or implied warranties made by agents, dealers, sales representatives or any other representatives, including any warranty of merchantability or fitness for a particular purpose, are hereby excluded.

There are no representations as to the capacity or performance of the products sold hereunder except as set forth in the price book or quotation specifications, if any, and such representations are expressly conditioned upon the correctness of the data furnished by purchaser and upon the products being properly installed and maintained.

Knú, LLC's sole obligation shall be to repair any defective product or product component covered under this warranty, including shipping and labor, during the warranty period. In no event shall Knú, LLC be liable for any consequential or incidental damages, including lost profits or revenues incurred by the purchaser with respect to any goods furnished by Knú, LLC. Expenses incurred by purchaser in repairing or replacing Knú, LLC's product must be pre-approved in writing by Knú, LLC.

Knú, LLC offers no warranty on the following product components or characteristics: all forms of upholstery, including fabric, vinyl and leather, as well as wood grain, color and texture. Knú, LLC offers no warranty on COM, COL, or any other special order fabric used at the request of the Purchaser.

Warranties offered by cover suppliers to Knú, LLC, if any, are hereby assigned to Purchaser.

In the event a product has to be returned to the factory for verification of a defect and/or repair, it must be pre-approved in writing by Knú, LLC, freight pre-paid, and include a copy of the original invoice with the date and name of original purchaser.

Knú, LLC hereby assigns to the original owner any and all warranties offered by its component suppliers. To the extent the terms of these warranties differ from the terms of the Limited Warranty, the terms of the suppliers' component warranties shall apply. However, Knú, LLC does not guarantee that the component supplier will comply with any terms of the warranty of such supplier.

KNÚ, LLC WILL NOT BE LIABLE FOR ANY CONSEQUENTIAL OR INCIDENTAL DAMAGES INCLUDING ANY LOSS, EXPENSE, OR DAMAGE OTHER THAN TO THE PRODUCT ITSELF THAT MAY RESULT FROM A DEFECT IN THE PRODUCT. SOME STATES DO NOT ALLOW FOR THE EXCLUSION OR LIMITATION OF CONSEQUENTIAL AND INCIDENTAL DAMAGES, SO THE ABOVE LIMITATION OR EXCLUSION MAY NOT APPLY.

KNÚ, LLC MAKES NO IMPLIED WARRANTIES OF MERCHANTABILITY OR FITNESS FOR A PARTICULAR PURPOSE. THESE AND ALL OTHER IMPLIED WARRANTIES ARE SPECIFICALLY DISCLAIMED. SOME STATES DO NOT ALLOW AN EXCLUSION OR LIMITATION ON HOW LONG AN IMPLIED WARRANTY LASTS, SO THE ABOVE LIMITATIONS OR EXCLUSIONS MAY NOT APPLY.

THIS WARRANTY GIVES YOU, THE ORIGINAL PURCHASER, SPECIFIC LEGAL RIGHTS AND YOU MAY ALSO HAVE OTHER RIGHTS THAT VARY FROM STATE TO STATE. EXCEPT FOR SUCH OTHER RIGHTS, THE REMEDIES PROVIDED UNDER THIS WARRANTY STATE THE LIMIT OF KNÚ, LLC'S RESPONSIBILITIES.



U.S. General Services Administration
 GSA Contract #: GS-28F-0008V
 Contract Period: 12/3/08 - 12/2/2028
 Price List Effective Date: 06/01/2021
 Knú, LLC. DBA: La-Z-Boy Healthcare & Knú Comfort
 Website: www.getknu.com | www.lzbcontract.com

- 1. Special Item Number (SIN): 339113H Healthcare Furniture
 OLM Order-Level Materials
 33721 Office Furniture*
**Includes Installation Services: 15% of the net price of the purchase order up to \$150,000. All orders over \$150,000 will be determined on a case-by-case basis.*
- 2. Delivery Time: 5 weeks ARO (35 Days ARO)
- 3. Point of Production: 1300 North Broad Street, Leland, MS 38756
- 4. FOB Terms: FOB Origin, Freight Prepay, Plus a \$100 handling fee for all orders less than \$1,500.00 Net
 International shipments, shipments into Puerto Rico, and shipments into the states of Hawaii and Alaska are freight prepaid to the port of exit. Please call Customer Service for a quote on special packing for overseas container shipments
- 5. Prompt Payment Terms: Net 30
- 6. Minimum Order: \$100 Net
- 7. Maximum Order: \$200,000 Net
- 8. Warranty: Standard Commercial Warranty
- 9A. Ordering Address: Knú, LLC | DBA / La-Z-Boy Healthcare & Knú Comfort
 P.O. Box 9, Ferdinand, IN 47532
- 9B. Remit to Address: Knú, LLC | DBA / La-Z-Boy Healthcare & Knú Comfort
 1597 Momentum Place, Chicago, IL 60689
- 10. Credit Cards Accepted: Visa, MasterCard, Discover, and American Express
- 11. Return Policy/Restocking Fee: No returns of merchandise will be accepted without written authorization from Knú, LLC.
 If authorized, the customer will pay all freight charges and a 30% (Net Price) restocking fee will be assessed.
- 12. Cancellation Policy: No charge prior to production. After production has begun, only actual costs that the contractor can demonstrate will be charged.
- 13. Rental, Maintenance, Repair: N/A
- 14. Repair Parts: See Warranty
- 15. List of Participating Dealers: Contact Customer Service
- 16. Dealer Registration: The name of the dealer must appear on the GSA Purchase Order.
- 17. GSA Customer Service: E-Mail: gsasales@getknu.com | Phone: 812-367-0136 | Fax: 812-367-2493
- 18. DUNS Number: 197589893
 FED ID Number: 20-2599789
 Cage Code Number: 4CDQ5
- 19. GSA Discount: 61.2% Off List



HEALTHTRUST®

Contract #: HPG-22449
Contract Period: 09/01/2017-11/30/2027
FED ID #: 20-2599789
HealthTrust Member Pricing: Price Guide effective 1/1/2024. Must use current fabric grades at time of order.
Freight Fee: 2% of List
Customer Service: 812-367-2068 or customerservice@getknu.com
NOTES: La-Z-Boy® Healthcare | Knú Comfort® sells dealer and dealer invoices end-user directly.



Contract #: PP-FA-2017
Contract Period: 01/01/2024 - 12/31/2026
FED ID #: 20-2599789
Premier Member Pricing: Price Guide effective 1/1/2024. Must use current fabric grades at time of order.
Freight Fee: 2% of List
Customer Service: 812-367-2068 or customerservice@getknu.com
NOTES: La-Z-Boy® Healthcare | Knú Comfort® sells dealer and dealer invoices end-user directly.

For information on state and other contracts, please visit getknu.com/resources/company-resources/contracts/

CAL 117 | CAL133

All Knú, LLC standard upholstered seating and the filling materials used in the construction of our seating, either meet or exceed the flammability requirements of Cal 117-2013. Knú, LLC will manufacture its seating when requested by a customer or where required by law to meet or exceed the flammability requirements of California Technical Bulletin 133. CAL TB133 requires actual tests of the complete unit and not just the components as CAL 117-2013 does. CAL TB133 is specific to the fabric, frame, and all filaments.

Knú, LLC recommends the use of a CAL 117-2013 Fabric, Fire Resistant Foam, and a Fire Resistant Barrier for a successful CAL TB133 burn test; however, this alone does not guarantee a product will pass the burn test. The cost of a burn test is \$500 (net) plus the cost of the product, along with the barrier and the fabric. Please allow a minimum of six (6) weeks for the production of the product and the completion of the test. Once the product successfully passes the burn test a certificate will be supplied.

If you do not need actual certification, the product can be upholstered using Fire Resistant Foam and the Fire Resistant Barrier at an upcharge of \$80 List per yard. Use the COM yardage requirements for your upcharge formula. COM yardage requirements are located on the individual product pages. (Please note that your COM fabric selection must pass CAL 117-2013 which will be stated in your fabric specifications.)

When sending in COM to have CAL TB133 added, Knú, LLC will need an additional yardage amount equal to either 5% of the total yardage, or 1 yard, whichever is the greatest. CAL TB133 cannot be added to leather.

CAL TB133 outlines the method and technique to which the furniture should be tested. Beyond that, it leaves classifications of furniture fabric to the discretion of the manufacturer/supplier of the fabric over which Knú, LLC has no control. Knú, LLC has tested a variety of chairs and fabrics with successful test results. Knú, LLC then cross-referenced similar models to see which ones would be applicable; however, this does not constitute a certification of an actual burn test.

The following upholstered frames have passed the CAL TB133 Fire Test for furniture manufactured for public area use. Please contact customer service for pricing and lead times.

Model	Textile
Dalton DL10	Maharam Article Flume (458600-013)
EV Collection E4017	CF Stinson Script Spearmint (ST10)
Harmony H5017	Arc-Com Frontier AC - 67492
	CF Stinson Script Palm (SCT 20)
	Maharam Medium Marina (022)
	Momentum Bravo Tumbleweed

UL Listing

All electrical components used in Knú, LLC products are UL listed. A UL listing for an entire Knú, LLC product can be obtained at an additional charge. Please contact customer service for pricing and lead times.

Note: Knú, LLC makes no recommendations or representations regarding whether CAL 133 certification or UL listing is required for the lawful use of Knú, LLC products. It is the sole responsibility of the customer to ascertain and comply with the laws, ordinances, regulations and codes of their particular jurisdiction that apply to their use of Knú, LLC products.

Product Take Back Program

Knú, LLC is proud to offer ANEW to customers dedicated to strengthening their community network by repurposing their furniture, fixtures, and architectural materials to those in need. In 2014, Knú, LLC committed to making this relationship a part of our strategic sales strategy. Visit www.anewfound.org for more information.

To initiate a product take back strategy, contact Customer Service at customerservice@getknu.com.

GREENGUARD Gold Certification www.greenguard.org



GREENGUARD Gold Certification (formerly known as GREENGUARD Children & Schools Certification) offers stricter certification criteria, considers safety factors to account for sensitive individuals (such as children and the elderly), and ensures that a product is acceptable for use in environments such as schools and healthcare facilities. It is referenced by both The Collaborative for High Performance Schools (CHPS) and the Leadership in Energy and Environmental Design (LEED) Building Rating System.

level® Certification www.levelcertified.org



BIFMA's e3 Furniture Sustainability Standard is a voluntary, multi-attribute standard that measures the degree of sustainability of furniture. This standard evaluates product and company environmental attributes and compliance systems in a wide range of elements, including Materials, Energy & Atmosphere, Human & Ecosystem Health, and Social Responsibility.

Additional Sustainability Information

For additional information on our environmental commitment and a full sustainability report, please visit getknu.com/resources/company-resources/sustainability/

Moisture Barrier Options

Moisture barriers that are designed to prevent liquid penetration to the foam and other filling materials are available on most items at an additional charge. Moisture barriers are applied between the upholstery cover and filling materials. The following list price upcharge will apply to each surface on which the protective barriers may be applied.

Part Number/Description	List Price
MBB Chair/Recliner Back.....	59
MBS Chair/Recliner Seat.....	59
MB2B Bariatric Chair/Bariatric Recliner Back.....	89
MB2S Bariatric Chair/Bariatric Recliner Seat	89
MB3B Loveseat Back	119
MB3S Loveseat Seat	119
MB4B Sofa/Sleep Sofa Back	179
MB4S Sofa/Sleep Sofa Seat	179
MB5B Sleep Chair Back	59
MB5SE Sleep Chair Seat and Extensions	179*

*List per seat

Dillon / Carson Pricing Grade

Upholstered product pricing grade "Dillon/Carson" is exclusive to products specified with the textiles Dillon by Culp Contract or Carson CV by Momentum Textiles & Wallcovering.

Dillon - Culp Contract

Content: 100% Polyurethane
 Backing: 70% Polyester / 30% Cotton
 For full specs, available colorways, & cleaning info, visit www.culpcontract.com

Carson CV - Momentum Textiles & Wallcovering

Content: 100% Clean Vinyl/Phthalate Free
 Backing: Polyester
 For full specs, available colorways, & cleaning info, visit www.momentumtextilesandwalls.com

Repeating/Matching Textile Patterns

Specified textiles that have a repeating pattern will be applied in a non-matching layout to increase yield. If a matching application is preferred, please contact customer service to request a quote.

COM (Customer's Own Material)

All Knú, LLC seating styles are available in COM. Prices are listed in the column containing the Grade of COM. Yardage requirements are based on non-directional 54" wide (between selvage edges) fabric. All fabrics must be backed with an appropriate type backing. Do not send wall coverings or drapery fabrics. COM material must be shipped from fabric supplier in continuous yardage. Knú, LLC cannot accept individual pieces of the same fabric.

Please complete the COM form and ship form along with the fabric sample for approval prepaid to:

Knú Design Center
 ATTN: COM Department
 P. O. Box 9, One Best Drive
 Ferdinand, IN 47532

Once COM fabric has been approved send COM yardage to:

Knú, LLC DBA La-Z-Boy Healthcare | Knú Comfort
 ATTN: COM Department
 1300 North Broad Street, Leland, MS 38756

Please send purchase order to:

Knú, LLC DBA La-Z-Boy Healthcare | Knú Comfort
 P.O. Box 9, Ferdinand, IN 47532
 Fax: 812-367-2493
 E-mail: orders@getknu.com

Knú, LLC must receive the purchase order prior to receiving the COM yardage. Lead time does not begin until the COM yardage has been received by the COM Department at Leland, MS.

Please attach a sample of your material to the COM form and indicate the direction it is to be applied. Unless otherwise directed, all COM will be applied up the roll with no pattern. Since some fabrics are reversible, please attach the fabric such that the exposed side is facing outward. Knú, LLC does not warrant COM fabrics.

Refer to individual product pages for standard COM yardage requirements. For fabrics with railroads or repeats please refer to the Textile Pattern Repeats chart on the following page.

When sending in COM to have CAL133 backing added, Knú, LLC will need an additional yardage amount equal to either 5% of the total yardage, or 1 yard, whichever is the greatest.

When COM is accepted, Knú, LLC assumes no responsibility for the appearance, behavior, or durability of the COM. Knú, LLC will inspect all COM fabrics upon receipt at the plant, but will not be held responsible for variations of dye lots, wear, fading, pattern matches, and/or flaws.

Textile Pattern Repeats

Specified textiles that have a repeating pattern will be applied in a non-matching layout to increase yield. If a matching application is preferred, please contact customer service to request a quote. Use the below to figure additional COM yardage required.

The chart below represents a patterned fabric being selected with a repeat. When a multiple repeat is present, the calculation for the yardage needed is determined by adding the vertical and horizontal measurements together and then referring to the chart for the extra yardage required. For example, on a guest chair a 4" vertical repeat and a 5" horizontal repeat requires 18.5% additional COM yardage if the pattern is directed across the roll, or 23.5% if the pattern is directed up the roll.

RR
Across the Roll
Railroaded

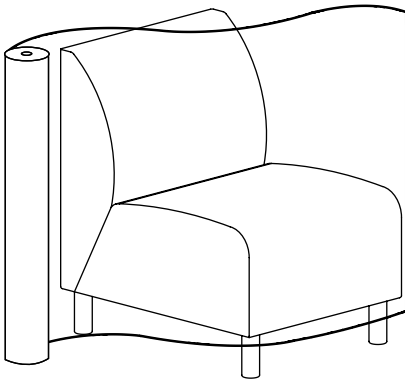

UR
Up the Roll

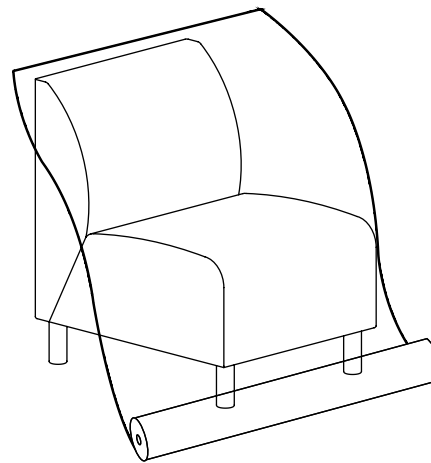

Guest/Visitor & Tandem Seating

Repeat (in inches)	Cut Across The Roll (RR)	Cut Up The Roll (UR)	2-Way Call for quote
¼" - 3"	Add 7.5%	Add 12.5%	
3 ¼" - 6"	Add 16.5%	Add 20%	
6 ¼" - 9"	Add 18.5%	Add 23.5%	
9 ¼" - 12"	Add 23%	Add 28%	
12 ¼" - 15"	Add 25%	Add 30%	
15 ¼" - 33"	Add 35%	Add 40%	

Upholstered Lounge/Tandem Seating & Sleep Chairs/Sleep Sofas

Repeat (in inches)	Cut Across The Roll (RR)	Cut Up The Roll (UR)	2-Way Call for quote
¼" - 3"	Add 8%	Add 13%	
3 ¼" - 6"	Add 17.5%	Add 22.5%	
6 ¼" - 9"	Add 18.5%	Add 23.5%	
9 ¼" - 15"	Add 20%	Add 25%	
15 ¼" - 21"	Add 30%	Add 35%	
21 ¼" - 33"	Add 35%	Add 40%	

Recliners & Gliders

Repeat (in inches)	Cut Across The Roll (RR)	Cut Up The Roll (UR)	2-Way Call for quote
¼" - 3"	Add 9%	Add 14%	
3 ¼" - 9"	Add 13.5%	Add 17%	
9 ¼" - 15"	Add 20%	Add 25%	
15 ¼" - 21"	Add 25%	Add 30%	
21 ¼" - 33"	Add 30%	Add 35%	

COM Form

(Entire form must be filled out.)



Dealer Name:		Fabric Supplier:		
Address:		Pattern Name & Number:	Total Yardage Being Provided:	
City/State/Zip:				
Contact Name:		Pattern Repeat (in inches) <i>*Order will not be processed w/out this information.</i>		
Telephone:		None:	Vertical:	Horizontal:
Dealer Account #:		Purchase Order #:		

Quantity	Model Number	Textile Supplier/Textile Color Name/Number	Finish	Tag

Attach fabric sample below, face side up in the direction it is to be applied to the chair.

*Please Note: COM material must be shipped in continuous yardage from the fabric supplier.
We cannot accept piece mill yardage or individual pieces of the same fabric.

*Fabric must be tagged with the PO# and dealer name.

*Fabric will be applied according to supplier recommendation unless otherwise instructed.

*Add 1 yard or 5% (whichever is the greater of the 2) if CAL133 will be added to COM.

Ship This Form with Sample To:

Knú, LLC
 DBA/La-Z-Boy Healthcare
 Attention: COM Department
 P.O. BOX 9
 824 W 23rd Street
 Ferdinand, IN 47532

Send Purchase Order To:

Knú, LLC
 DBA/La-Z-Boy Healthcare
 P.O. Box 9
 Ferdinand, IN 47532
 Fax: 812.367.2493
 customerservice@getknu.com

Ship COM/COL Yardage To:

Knú, LLC
 DBA/La-Z-Boy Healthcare
 Attention: COM Department
 1300 North Broad Street
 Leland, MS 38756

INDEX BY MODEL NUMBER

AS10N	63	E3017	119	EC4125	113	KAL361J	41
AS10NC	63	E3062	121	EC4127	116	KAL361U	41
AS12AF	64	E3067	120	EC4162	131	KAM10BH1PJ	36
AS12AJ	64	E3117	119	EC4167	128	KAM10BH1PU	36
AS12AU	64	E3162	121	ECDO0N0	97	KAM10BHJ	20
AS12LF	64	E3167	120	ECD17N0	96	KAM10BHU	20
AS12LJ	64	E4017	123	ECE00N0	95	KAM10BJ	19
AS12LU	64	E4062	131	ECE17N0	94	KAM10BU	19
AS12RF	65	E4067	128	ECF01N0	89	KAM10HIPJ	35
AS12RJ	65	E4117	123	ECHO2N0	93	KAM10HIPU	35
AS12RU	65	E4125	113	GANG BRKT KOT	25	KAM10HJ	18
AS20N	63	E4127	116	GANG BRKT KOT	32	KAM10HU	18
AS22AF	65	E4162	131	GOT00	90	KAM10J	18
AS22AJ	65	E4167	128	H1700	164	KAM10U	18
AS22AU	65	EB1037	137	H1800	164	KAM12J	19
AS22LF	66	EB1062	142	H1900	164	KAM12U	19
AS22LJ	66	EB1067	140	H5017	125	KAM20IBLJ	21
AS22LU	66	EB1137	137	H5037	139	KAM20IBLU	21
AS22RF	66	EB1162	142	H5047	134	KAM20IBRJ	22
AS22RJ	66	EB1167	140	H5057	144	KAM20IBRU	22
AS22RU	66	EB4037	138	H5117	125	KAM20IJ	21
AS30N	63	EB4062	143	H5137	139	KAM20IU	21
AS32AF	67	EB4067	141	H5147	134	KAM20J	20
AS32AJ	67	EB4137	138	H5157	144	KAM20U	20
AS32AU	67	EB4162	143	HC5017	125	KAM30IB1CJ	23
AS32LF	67	EB4167	141	HC5037	139	KAM30IBCU	23
AS32LJ	67	EBC1037	137	HC5047	134	KAM30IBLJ	23
AS32LU	67	EBC1062	142	HC5057	144	KAM30IBLU	23
AS32RF	68	EBC1067	140	HC5117	125	KAM30IBRJ	24
AS32RJ	68	EBC1137	137	HC5137	139	KAM30IBRU	24
AS32RU	68	EBC1162	142	HC5147	134	KAM30IJ	22
AS90IC	69	EBC1167	140	HC5157	144	KAM30IU	22
AS90OC	69	EBC4037	138	K0017	87	KAS10A	73
ASB2424	69	EBC4062	143	K0107	103	KAS10BA	74
ASB2448	69	EBC4067	141	K0167	104	KAS10BF	74
ASB2472	70	EBC4137	138	K1017	122	KAS10F	73
ASB3024	70	EBC4162	143	K1042	135	KAS13A	73
ASB3048	70	EBC4167	141	K1047	133	KAS13BA	74
ASB3072	70	EC1017	122	K1062	130	KAS13BF	74
AST10	71	EC1042	135	K1067	127	KAS13F	73
AST15	71	EC1047	133	K1117	122	KAS18A	75
AST90	71	EC1062	130	K1125	112	KAS18F	75
DL10	61	EC1067	127	K1127	115	KAS20A	75
DL20	61	EC1117	122	K1142	135	KAS20F	75
DL30	61	EC1125	112	K1147	133	KAS23A	76
E0700	161	EC1125L	114	K1162	130	KAS23F	76
E0722	161	EC1125R	114	K1167	127	KAS28A	76
E0800	161	EC1127	115	K1716	90	KAS28F	76
E0900	161	EC1127L	117	K3017	119	KAS30A	77
E1017	122	EC1127R	117	K3062	121	KAS30F	77
E1042	135	EC1142	135	K3067	120	KAS33A	77
E1047	133	EC1147	133	K3117	119	KAS33F	77
E1062	130	EC1162	130	K3162	121	KAS38A	78
E1067	127	EC1167	127	K3167	120	KAS38F	78
E1117	122	EC1304	91	KAL12BJ	38	KB1037	137
E1125	112	EC1306	88	KAL12BU	38	KB1062	142
E1125L	114	EC2017	126	KAL12J	38	KB1067	140
E1125R	114	EC2062	132	KAL12U	38	KB1137	137
E1127	115	EC2067	129	KAL24IBLJ	40	KB1162	142
E1127L	117	EC2117	126	KAL24IBLU	40	KB1167	140
E1127R	117	EC2162	132	KAL24IBRJ	40	KBC1037	137
E1142	135	EC2167	129	KAL24IBRU	40	KBC1062	142
E1147	133	EC3017	119	KAL24IJ	39	KBC1067	140
E1162	130	EC3062	121	KAL24IU	39	KBC1137	137
E1167	127	EC3067	120	KAL24U	39	KBC1162	142
E1716	90	EC3117	119	KAL24U	39	KBC1167	140
E2017	126	EC3162	121	KAL361BCJ	41	KC1P04	92
E2062	132	EC3167	120	KAL361BCU	41	KC7X18	156
E2067	129	EC4017	123	KAL361BLJ	42	KC7X62	158
E2117	126	EC4062	131	KAL361BLU	42	KC7X67	157
E2162	132	EC4067	128	KAL361BRJ	42	KC8L04	101
E2167	129	EC4117	123	KAL361BRU	42	KC8L14	101

INDEX BY MODEL NUMBER

KC8P04.....	100	KMB1167.....	140	KOT20IBRU.....	29	R1700.....	162
KC8P14.....	100	KMBC1037.....	137	KOT20IU.....	29	R1716.....	90
KC1017.....	122	KMBC1062.....	142	KOT20U.....	28	R1722.....	162
KC1042.....	135	KMBC1067.....	140	KOT24R.....	33	R1800.....	162
KC1047.....	133	KMBC1137.....	137	KOT29IU.....	81	R1900.....	162
KC1062.....	130	KMBC1162.....	142	KOT29U.....	80	R3017.....	119
KC1067.....	127	KMBC1167.....	140	KOT30IBCU.....	30	R3062.....	121
KC1117.....	122	KMC7X18.....	156	KOT30IBLU.....	30	R3067.....	120
KC1125.....	112	KMC7X62.....	158	KOT30IBRU.....	31	R3117.....	119
KC1127.....	115	KMC7X67.....	157	KOT30IU.....	30	R3162.....	121
KC1142.....	135	KMC1017.....	122	KOT36R.....	33	R3167.....	120
KC1147.....	133	KMC1062.....	130	KOT39IU.....	81	RB1037.....	137
KC1162.....	130	KMC1067.....	127	KOT2020.....	33	RB1062.....	142
KC1167.....	127	KMC1117.....	122	KOT2420.....	33	RB1067.....	140
KC1304.....	91	KMC1125.....	112	KOT3636.....	33	RB1137.....	137
KC1306.....	88	KMC1125L.....	114	KOT4820.....	33	RB1162.....	142
KC3017.....	119	KMC1125R.....	114	KOU10.....	55	RB1167.....	140
KC3062.....	121	KMC1127.....	115	KOU10B.....	55	RBC1037.....	137
KC3067.....	120	KMC1127L.....	117	KOU15T.....	59	RBC1062.....	142
KC3117.....	119	KMC1127R.....	117	KOU19.....	82	RBC1067.....	140
KC3162.....	121	KMC1162.....	130	KOU19-M.....	82	RBC1137.....	137
KC3167.....	120	KMC1167.....	127	KOU20.....	55	RBC1162.....	142
KC8004.....	98	KMC3017.....	119	KOU20I.....	56	RBC1167.....	140
KC8006.....	99	KMC3062.....	121	KOU20IBL.....	57	RC7X18.....	156
KC8014.....	98	KMC3067.....	120	KOU20IBR.....	57	RC7X62.....	158
KC8016.....	99	KMC3117.....	119	KOU20IT.....	56	RC7X67.....	157
KCDO0N0.....	97	KMC3162.....	121	KOU20T.....	56	RC1017.....	122
KCD17N0.....	96	KMC3167.....	120	KOU29.....	82	RC1042.....	135
KCE00N0.....	95	KMCZL17.....	149	KOU29I.....	83	RC1047.....	133
KCE17N0.....	94	KMCZL62.....	151	KOU30.....	57	RC1062.....	130
KCF01N0.....	89	KMCZL67.....	150	KOU30I.....	58	RC1067.....	127
KCH02N0.....	93	KMCZP17.....	146	KOU30IBC.....	58	RC1117.....	122
KCZL17.....	149	KMCZP62.....	148	KOU30IBL.....	58	RC1125.....	112
KCZL62.....	151	KMCZP67.....	147	KOU30IBR.....	59	RC1125L.....	114
KCZL67.....	150	KMCZX17.....	153	KOU39.....	83	RC1125R.....	114
KCZP17.....	146	KMCZX62.....	155	KOU39I.....	83	RC1127.....	115
KCZP62.....	148	KMCZX67.....	154	KOU90T.....	59	RC1127L.....	117
KCZP67.....	147	KMU10.....	49	KTC07.....	25	RC1127R.....	117
KCZX17.....	153	KMU10B.....	49	KTC07.....	32	RC1142.....	135
KCZX62.....	155	KMU20.....	49	KTE07L.....	25	RC1147.....	133
KCZX67.....	154	KMU20I.....	50	KTE07L.....	32	RC1162.....	130
KL1017.....	124	KMU20IBL.....	51	KTE07R.....	25	RC1167.....	127
KL1117.....	124	KMU20IBR.....	51	KTE07R.....	32	RC1304.....	91
KLC1017.....	124	KMU20IT.....	50	KTI07.....	25	RC1306.....	88
KLC1117.....	124	KMU20T.....	50	KTI07.....	32	RC3017.....	119
KM1017.....	122	KMU30.....	51	M0107.....	105	RC3062.....	121
KM1062.....	130	KMU30I.....	52	N70XXXUF.....	170	RC3067.....	120
KM1067.....	127	KMU30IBC.....	52	N78XXXUF.....	170	RC3117.....	119
KM1117.....	122	KMU30IBL.....	52	OC2176UF.....	166	RC3162.....	121
KM1125.....	112	KMU30IBR.....	53	ON2076HPUF.....	167	RC3167.....	120
KM1125L.....	114	KOL12BU.....	44	ON2076UF.....	167	RCD00N0.....	97
KM1125R.....	114	KOL12U.....	44	ON2176UF.....	166	RCD17N0.....	96
KM1127.....	115	KOL24IBLU.....	45	OO2176UF.....	166	RCE00N0.....	95
KM1127L.....	117	KOL24IBRU.....	45	OW2176UF.....	166	RCE17N0.....	94
KM1127R.....	117	KOL24IU.....	45	PT.....	25	RCF01N0.....	89
KM1162.....	130	KOL24U.....	44	R1017.....	32	RCH02N0.....	93
KM1167.....	127	KOL36BCU.....	46	R1042.....	122	RCZL17.....	149
KM1700.....	163	KOL36IBLU.....	46	R1047.....	135	RCZL62.....	151
KM1722.....	163	KOL36IBRU.....	47	R1062.....	133	RCZL67.....	150
KM1800.....	163	KOL36IU.....	46	R1067.....	130	RCZP17.....	146
KM1900.....	163	KOT00.....	24	R1107.....	127	RCZP62.....	148
KM3017.....	119	KOT00.....	31	R1117.....	122	RCZP67.....	147
KM3062.....	121	KOT10BHIPU.....	36	R1125.....	112	RCZX17.....	153
KM3067.....	120	KOT10BHU.....	28	R1125L.....	114	RCZX62.....	155
KM3117.....	119	KOT10BU.....	28	R1125R.....	114	RCZX67.....	154
KM3162.....	121	KOT10HIPU.....	35	R1127.....	115		
KM3167.....	120	KOT10HU.....	27	R1127L.....	117		
KMB1037.....	137	KOT10U.....	27	R1127R.....	117		
KMB1062.....	142	KOT12U.....	27	R1142.....	135		
KMB1067.....	140	KOT19U.....	80	R1147.....	133		
KMB1137.....	137	KOT19UM.....	80	R1162.....	130		
KMB1162.....	142	KOT20IBLU.....	29	R1167.....	127		

PUBLIC AREA SEATING

Visitor

Kadia Mod Metal Visitor	17
Koncert Metal Visitor	26
Koncert Kadia Occasional Tables	33
Koncert Kadia Hip Chair	34

Metal Lounge

Kadia Mod Metal Lounge	37
Koncert Metal Lounge	43

Upholstered Lounge

Kadia Mod Upholstered Lounge	48
Koncert Upholstered Lounge	54
Dalton Lounge	60
Assymble Modular Lounge	62
Kascade Lounge	72
Koncert Behavioral Health	79





General Product Information

- Passive Flex Back
- Seat clean-out
- Wall-saver leg design
- Adjustable glides
- 16 gauge steel frame
- Arms connected by heavy steel rails
- Molded seat foam on 21" seats
- Back foam: 1.7 density foam that meets CAL 117 Fire Standards
- Comfort webbing in seats
- Field replaceable components

To Order, Specify

- Model Number
- Textile
- Finish
- Options

Available Options

<p>FRAME OPTIONS <i>See pg 2 for finishes</i> <i>*Standard in 540 Pewter finish</i></p> <p>ARM CAP OPTIONS <i>See pg 2 for finishes</i></p> <p>U Urethane Standard on specified models J Solid Surface Standard on specified models</p>	<p>ADDITIONAL FEATURES & OPTIONS</p> <p>CAL CAL TB133 See pg 9 Z Multi Cover Use Pricing for Highest Grade MB Moisture Barrier See pg 11</p>
---	---

KAM10 - Guest Chair

Dimensions

Overall			Seat		
W	D	H	W	D	H
24.5	29.5	33.25	20.75	19.5	18.25
			Back H	Arm H	
			15	25.5	

COM: 2 yds
 Wt Cap: 550 lb
 Unit Weight: 45 lb

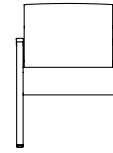

KAM10U with Urethane Arm Caps

COM	Dillon	Carson	A ₅	B ₆	C ₇	D ₈	E ₉	F ₁₀	G ₁₁	H ₁₂	I ₁₃
1399	1419	1469	1499	1579	1639	1679	1749	1929	2049	2169	

KAM10J with Solid Surface Arm Caps (Add \$50 List per arm cap for Group 2 solid surface finish)

COM	Dillon	Carson	A ₅	B ₆	C ₇	D ₈	E ₉	F ₁₀	G ₁₁	H ₁₂	I ₁₃
1979	1999	2059	2089	2149	2209	2269	2339	2499	2639	2769	

KAM10H - High Back Guest Chair

Dimensions

Overall			Seat		
W	D	H	W	D	H
24.5	29.5	45.5	20.75	19	18.25
			Back H	Arm H	
			26.75	25.5	

COM: 2 yds
 Wt Cap: 550 lb
 Unit Weight: 50 lb

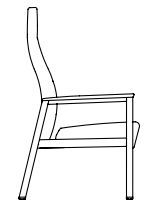
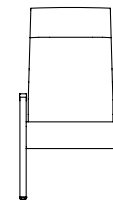

KAM10HU with Urethane Arm Caps

COM	Dillon	Carson	A ₅	B ₆	C ₇	D ₈	E ₉	F ₁₀	G ₁₁	H ₁₂	I ₁₃
1639	1649	1689	1719	1799	1859	1909	1979	2149	2299	2419	

KAM10HJ with Solid Surface Arm Caps (Add \$50 List per arm cap for Group 2 solid surface finish)

COM	Dillon	Carson	A ₅	B ₆	C ₇	D ₈	E ₉	F ₁₀	G ₁₁	H ₁₂	I ₁₃
2209	2219	2289	2319	2369	2429	2469	2569	2719	2899	3029	

KAM12 - Guest Chair - 24" Seat

Dimensions

Overall			Seat		
W	D	H	W	D	H
27.25	29.5	33.25	24	19.5	18.25
			Back H	Arm H	
			15	25.5	

COM: 2 yds
 Wt Cap: 550 lb
 Unit Weight: 50 lb

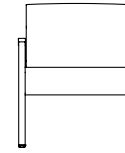

KAM12U with Urethane Arm Caps

COM	Dillon	Carson	A ₅	B ₆	C ₇	D ₈	E ₉	F ₁₀	G ₁₁	H ₁₂	I ₁₃
1489	1509	1579	1609	1659	1719	1759	1829	1989	2119	2239	

KAM12J with Solid Surface Arm Caps (Add \$50 List per arm cap for Group 2 solid surface finish)

COM	Dillon	Carson	A ₅	B ₆	C ₇	D ₈	E ₉	F ₁₀	G ₁₁	H ₁₂	I ₁₃
2049	2079	2129	2159	2209	2289	2329	2389	2549	2839	2949	

KAM10B - Bariatric Guest Chair

Dimensions

Overall			Seat		
W	D	H	W	D	H
33.5	29.5	33.25	29.5	19.5	18.25
			Back H	Arm H	
			15	25.5	

COM: 3 yds
 Wt Cap: 750 lb
 Unit Weight: 65 lb

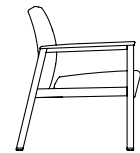
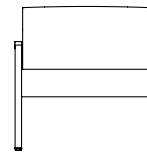

KAM10BU with Urethane Arm Caps

COM	Dillon	Carson	A ₅	B ₆	C ₇	D ₈	E ₉	F ₁₀	G ₁₁	H ₁₂	I ₁₃
1679	1709	1799	1869	1939	2059	2139	2239	2419	2639	2849	

KAM10BJ with Solid Surface Arm Caps (Add \$50 List per arm cap for Group 2 solid surface finish)

COM	Dillon	Carson	A ₅	B ₆	C ₇	D ₈	E ₉	F ₁₀	G ₁₁	H ₁₂	I ₁₃
2299	2329	2379	2449	2539	2639	2739	2819	3009	3289	3469	

KAM10BH - High Back Bariatric Guest Chair

Dimensions

Overall			Seat		
W	D	H	W	D	H
33.25	29.5	33.5	29.5	19	18.25
			Back H	Arm H	
			26.75	25.5	

COM: 3.5 yds
 Wt Cap: 750 lb
 Unit Weight: 72 lb

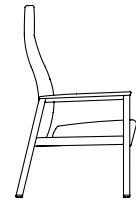
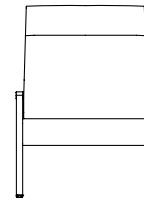

KAM10BHU with Urethane Arm Caps

COM	Dillon	Carson	A ₅	B ₆	C ₇	D ₈	E ₉	F ₁₀	G ₁₁	H ₁₂	I ₁₃
2109	2239	2349	2439	2519	2659	2799	2909	3139	3419	3629	

KAM10BHJ with Solid Surface Arm Caps (Add \$50 List per arm cap for Group 2 solid surface finish)

COM	Dillon	Carson	A ₅	B ₆	C ₇	D ₈	E ₉	F ₁₀	G ₁₁	H ₁₂	I ₁₃
2709	2839	2929	3049	3099	3269	3379	3539	3719	3849	3999	

KAM20 - 2 Seat Guest Chair

Dimensions

Overall			Seat		
W	D	H	W	D	H
45.5	29.5	33.25	42	19.5	18.25
			Back H	Arm H	
			15	25.5	

COM: 3 yds
 Wt Cap: 750 lb
 Unit Weight: 79 lb

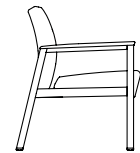
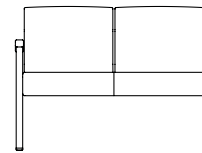

KAM20U with Urethane Arm Caps

COM	Dillon	Carson	A ₅	B ₆	C ₇	D ₈	E ₉	F ₁₀	G ₁₁	H ₁₂	I ₁₃
2239	2299	2369	2439	2529	2649	2759	2839	3009	3279	3479	

KAM20J with Solid Surface Arm Caps (Add \$50 List per arm cap for Group 2 solid surface finish)

COM	Dillon	Carson	A ₅	B ₆	C ₇	D ₈	E ₉	F ₁₀	G ₁₁	H ₁₂	I ₁₃
2849	2889	2949	3049	3109	3249	3339	3409	3559	3749	3949	

KAM20I - 2 Seat Guest Chair with Intervening Arm

Dimensions

Overall			Seat		
W	D	H	W	D	H
47	29.5	33.25	20.75	19.5	18.25
			Back H	Arm H	
			15	25.5	

COM: 3 yds
 Wt Cap: 1000 lb
 Unit Weight: 82 lb

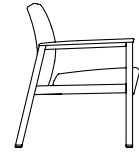
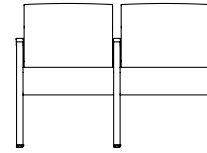

KAM20IU with Urethane Arm Caps

COM	Dillon	Carson	A ₅	B ₆	C ₇	D ₈	E ₉	F ₁₀	G ₁₁	H ₁₂	I ₁₃
2529	2569	2649	2709	2829	2909	3049	3119	3349	3579	3799	

KAM20IJ with Solid Surface Arm Caps (Add \$50 List per arm cap for Group 2 solid surface finish)

COM	Dillon	Carson	A ₅	B ₆	C ₇	D ₈	E ₉	F ₁₀	G ₁₁	H ₁₂	I ₁₃
3419	3479	3539	3599	3729	3809	3929	3999	4209	4319	4529	

KAM20IBL - 2 Seat Left 29.5" Bariatric Guest Chair with Intervening Arm

Dimensions

Overall			Seat		
W	D	H	W	D	H
58	29.5	33.25	20.75	19.5	18.25
			Back H	Arm H	
			15	25.5	

COM: 3.5 yds
 Wt Cap: 1000 lb
 Unit Weight: 87 lb

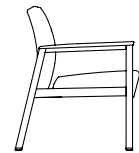
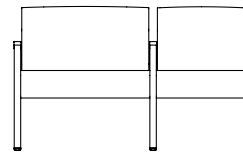

KAM20IBLU with Urethane Arm Caps

COM	Dillon	Carson	A ₅	B ₆	C ₇	D ₈	E ₉	F ₁₀	G ₁₁	H ₁₂	I ₁₃
2879	2899	3009	3089	3179	3319	3479	3569	3779	4029	4269	

KAM20IBLJ with Solid Surface Arm Caps (Add \$50 List per arm cap for Group 2 solid surface finish)

COM	Dillon	Carson	A ₅	B ₆	C ₇	D ₈	E ₉	F ₁₀	G ₁₁	H ₁₂	I ₁₃
3789	3809	3869	3989	4079	4209	4349	4449	4629	4899	5269	

KAM20IBR - 2 Seat Right 29.5" Bariatric Guest Chair with Intervening Arm

Dimensions

Overall			Seat		
W	D	H	W	D	H
58	29.5	33.25	20.75	19.5	18.25
			Back H	Arm H	
			15	25.5	

COM: 3.5 yds
 Wt Cap: 1000 lb
 Unit Weight: 87 lb

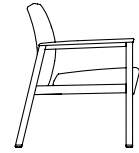
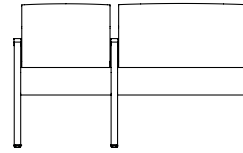

KAM20IBRU with Urethane Arm Caps

COM	Dillon	Carson	A ₅	B ₆	C ₇	D ₈	E ₉	F ₁₀	G ₁₁	H ₁₂	I ₁₃
2879	2899	3009	3089	3179	3319	3479	3569	3779	4029	4269	

KAM20IBRJ with Solid Surface Arm Caps (Add \$50 List per arm cap for Group 2 solid surface finish)

COM	Dillon	Carson	A ₅	B ₆	C ₇	D ₈	E ₉	F ₁₀	G ₁₁	H ₁₂	I ₁₃
3789	3809	3869	3989	4079	4209	4349	4449	4629	4899	5269	

KAM30I - 3 Seat Guest Chair with Intervening Arms

Dimensions

Overall			Seat		
W	D	H	W	D	H
69.5	29.5	33.25	20.75	19.5	18.25
			Back H	Arm H	
			15	25.5	

COM: 4.5 yds
 Wt Cap: 1000 lb
 Unit Weight: 120 lb

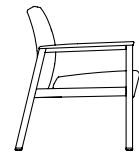
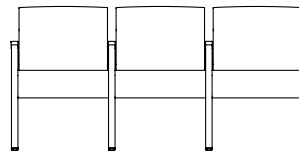

KAM30IU with Urethane Arm Caps

COM	Dillon	Carson	A ₅	B ₆	C ₇	D ₈	E ₉	F ₁₀	G ₁₁	H ₁₂	I ₁₃
3389	3429	3569	3659	3799	3989	4199	4259	4569	4899	5269	

KAM30IJ with Solid Surface Arm Caps (Add \$50 List per arm cap for Group 2 solid surface finish)

COM	Dillon	Carson	A ₅	B ₆	C ₇	D ₈	E ₉	F ₁₀	G ₁₁	H ₁₂	I ₁₃
4589	4629	4759	4839	4989	5169	5379	5429	5719	6179	6499	

KAM30IBC - 3 Seat Center 29.5" Bariatric Guest Chair with Intervening Arms

Dimensions

Overall			Seat		
W	D	H	W	D	H
78.25	29.5	33.25	20.75	19.5	18.25
			Back H	Arm H	
			15	25.5	

COM: 4.5 yds
 Wt Cap: 1000 lb
 Unit Weight: 127 lb

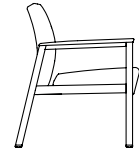
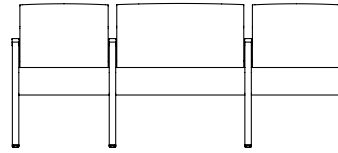

KAM30IBCU with Urethane Arm Caps

COM	Dillon	Carson	A ₅	B ₆	C ₇	D ₈	E ₉	F ₁₀	G ₁₁	H ₁₂	I ₁₃
3919	3989	4119	4249	4459	4649	4789	4939	5029	5399	5799	

KAM30IB CJ with Solid Surface Arm Caps (Add \$50 List per arm cap for Group 2 solid surface finish)

COM	Dillon	Carson	A ₅	B ₆	C ₇	D ₈	E ₉	F ₁₀	G ₁₁	H ₁₂	I ₁₃
5149	5179	5299	5439	5639	5829	5969	6089	6169	6319	6449	

KAM30IBL - 3 Seat Left 29.5" Bariatric Guest Chair with Intervening Arms

Dimensions

Overall			Seat		
W	D	H	W	D	H
78.25	29.5	33.25	20.75	19.5	18.25
			Back H	Arm H	
			15	25.5	

COM: 4.5 yds
 Wt Cap: 1000 lb
 Unit Weight: 127 lb

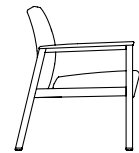
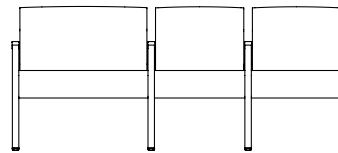

KAM30IBLU with Urethane Arm Caps

COM	Dillon	Carson	A ₅	B ₆	C ₇	D ₈	E ₉	F ₁₀	G ₁₁	H ₁₂	I ₁₃
3919	3989	4119	4249	4459	4649	4789	4939	5029	5399	5799	

KAM30IBL J with Solid Surface Arm Caps (Add \$50 List per arm cap for Group 2 solid surface finish)

COM	Dillon	Carson	A ₅	B ₆	C ₇	D ₈	E ₉	F ₁₀	G ₁₁	H ₁₂	I ₁₃
5149	5179	5299	5439	5639	5829	5969	6089	6169	6319	6449	

KAM30IBR - 3 Seat Right 29.5" Bariatric Guest Chair with Intervening Arms

Dimensions

Overall			Seat		
W	D	H	W	D	H
78.25	29.5	33.25	20.75	19.5	18.25
			Back H	Arm H	
			15	25.5	

COM: 4.5 yds
 Wt Cap: 1000 lb
 Unit Weight: 127 lb

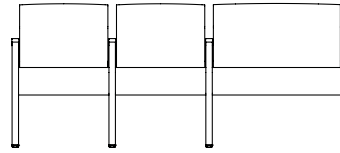

KAM30IBRU with Urethane Arm Caps

COM	Dillon/Carson	A ₅	B ₆	C ₇	D ₈	E ₉	F ₁₀	G ₁₁	H ₁₂	I ₁₃
3919	3989	4119	4249	4459	4649	4789	4939	5029	5399	5799

KAM30IBRJ with Solid Surface Arm Caps (Add \$50 List per arm cap for Group 2 solid surface finish)

COM	Dillon/Carson	A ₅	B ₆	C ₇	D ₈	E ₉	F ₁₀	G ₁₁	H ₁₂	I ₁₃
5149	5179	5299	5439	5639	5829	5969	6089	6169	6319	6449

KOT00 - K-Series Ottoman

Dimensions

Overall		
W	D	H
19	18.5	12

COM: 1 yds
 Unit Weight: 12 lb

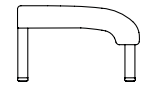
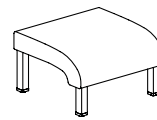

Pricing

COM	Dillon/Carson	A ₅	B ₆	C ₇	D ₈	E ₉	F ₁₀	G ₁₁	H ₁₂	I ₁₃
909	919	959	989	1019	1089	1139	1169	1189	1269	1339

KTC07 - Corner Ganging Table

Dimensions

Overall		
W	D	H
37	16	15

Unit Weight: 32 lb

Price
1119

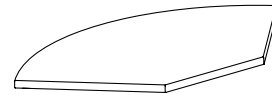

KTE07L - Left End Ganging Table (facing)

Dimensions

Overall		
W	D	H
15.5	20	15

Unit Weight: 32 lb

Price
909

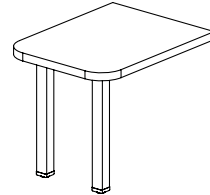

KTE07R - Right End Ganging Table (facing)

Dimensions

Overall		
W	D	H
15.5	20	15

Unit Weight: 32 lb

Price
909

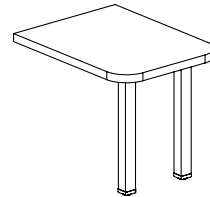

KTI07 - Intervening Ganging Table

Dimensions

Overall		
W	D	H
15.5	20	15

Unit Weight: 17 lb

Price
769

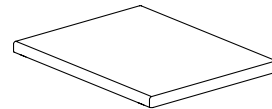

PT - Undermount Power

Dimensions

Overall		
W	D	H
9	12	2.25

Unit Weight: 2 lb

Price
269

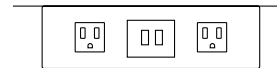

GANG BRKT KOT - Ganging Bracket

Dimensions

Overall		
W	D	H
11	0.25	3.5

Unit Weight: 4 lb

Price
79

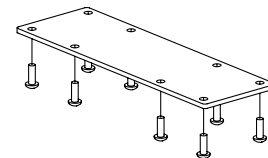

To Order, Specify

- Model Number
- Finish



General Product Information

- Passive Flex Back
- Seat clean-out
- Wall-saver leg design
- Adjustable glides
- 16 gauge steel frame
- Arms connected by heavy steel rails
- Molded seat foam on 21" seats
- Back foam: 1.7 density foam that meets CAL 117 Fire Standards
- Comfort webbing in seats
- Field replaceable components

To Order, Specify

- Model Number
- Textile
- Finish
- Options

Available Options

<p>FRAME OPTIONS <i>See pg 2 for finishes</i> <i>*Standard in 540 Pewter finish</i></p> <p>ARM CAP OPTIONS <i>See pg 2 for finishes</i></p> <p>U Urethane Standard</p>	<p>ADDITIONAL FEATURES & OPTIONS</p> <p>CAL CAL TB133 See pg 9</p> <p>Z Multi Cover Use Pricing for Highest Grade</p> <p>MB Moisture Barrier See pg 11</p>
--	--

KOT10 - Guest Chair

Dimensions

Overall			Seat		
W	D	H	W	D	H
24.5	29.5	33.25	20.75	19.5	18.25
			Back H	Arm H	
			15	25.75	

COM: 2 yds
 Wt Cap: 550 lb
 Unit Weight: 56 lb

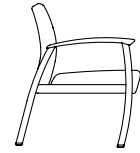
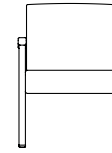

KOT10U with Urethane Arm Caps

COM	Dillon/Carson	A ₅	B ₆	C ₇	D ₈	E ₉	F ₁₀	G ₁₁	H ₁₂	I ₁₃
1399	1419	1469	1499	1579	1639	1679	1749	1929	2049	2169

KOT10H - High Back Guest Chair

Dimensions

Overall			Seat		
W	D	H	W	D	H
24.5	29.5	45	20.75	19	18.25
			Back H	Arm H	
			26.75	25.75	

COM: 2 yds
 Wt Cap: 550 lb
 Unit Weight: 61 lb

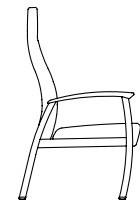
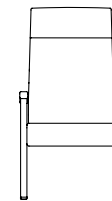

KOT10HU with Urethane Arm Caps

COM	Dillon/Carson	A ₅	B ₆	C ₇	D ₈	E ₉	F ₁₀	G ₁₁	H ₁₂	I ₁₃
1639	1649	1689	1719	1799	1859	1909	1979	2149	2299	2419

KOT12 - Guest Chair - 24" Seat

Dimensions

Overall			Seat		
W	D	H	W	D	H
27.25	29.5	33.25	24	19.5	18.25
			Back H	Arm H	
			15	25.75	

COM: 2 yds
 Wt Cap: 550 lb
 Unit Weight: 61 lb

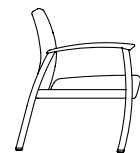
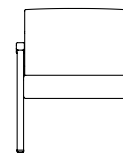

KOT12U with Urethane Arm Caps

COM	Dillon/Carson	A ₅	B ₆	C ₇	D ₈	E ₉	F ₁₀	G ₁₁	H ₁₂	I ₁₃
1489	1509	1579	1609	1659	1719	1759	1829	1989	2119	2239

KOT10B - Bariatric Guest Chair

Dimensions

Overall			Seat		
W	D	H	W	D	H
33.5	29.5	33.25	29.5	19.5	18.25
			Back H	Arm H	
			15	25.75	

COM: 3 yds
 Wt Cap: 750 lb
 Unit Weight: 76 lb

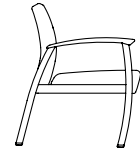
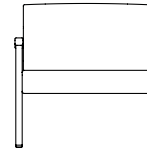

KOT10BU with Urethane Arm Caps

COM	Dillon/Carson	A ₅	B ₆	C ₇	D ₈	E ₉	F ₁₀	G ₁₁	H ₁₂	I ₁₃
1679	1709	1799	1869	1939	2059	2139	2239	2419	2639	2849

KOT10BH - High Back Bariatric Guest Chair

Dimensions

Overall			Seat		
W	D	H	W	D	H
33.5	29.5	45	29.5	19	18.25
			Back H	Arm H	
			26.75	25.75	

COM: 3 yds
 Wt Cap: 750 lb
 Unit Weight: 83 lb

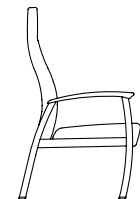
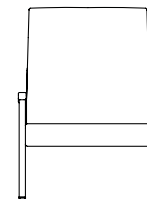

KOT10BHU with Urethane Arm Caps

COM	Dillon/Carson	A ₅	B ₆	C ₇	D ₈	E ₉	F ₁₀	G ₁₁	H ₁₂	I ₁₃
2109	2239	2349	2439	2519	2659	2799	2909	3139	3419	3629

KOT20 - 2 Seat Guest Chair

Dimensions

Overall			Seat		
W	D	H	W	D	H
45.5	29.5	33.25	42	19.5	18.25
			Back H	Arm H	
			15	25.75	

COM: 3 yds
 Wt Cap: 750 lb
 Unit Weight: 90 lb

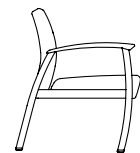
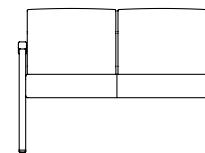

KOT20U with Urethane Arm Caps

COM	Dillon/Carson	A ₅	B ₆	C ₇	D ₈	E ₉	F ₁₀	G ₁₁	H ₁₂	I ₁₃
2239	2299	2369	2439	2529	2649	2759	2839	3009	3279	3479

KOT20I - 2 Seat Guest Chair with Intervening Arm

Dimensions

Overall			Seat		
W	D	H	W	D	H
47	29.5	33.25	20.75	19.5	18.25
			Back H	Arm H	
			15	25.75	

COM: 3 yds
 Wt Cap: 1000 lb
 Unit Weight: 101 lb

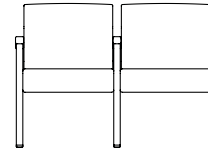

KOT20IU with Urethane Arm Caps

COM	Dillon/Carson	A ₅	B ₆	C ₇	D ₈	E ₉	F ₁₀	G ₁₁	H ₁₂	I ₁₃
2529	2569	2649	2709	2829	2909	3049	3119	3349	3579	3799

KOT20IBL - 2 Seat Left 29.5" Bariatric Guest Chair with Intervening Arm

Dimensions

Overall			Seat		
W	D	H	W	D	H
58	29.5	33.25	20.75	19.5	18.25
			Back H	Arm H	
			15	25.75	

COM: 3.49 yds
 Wt Cap: 1000 lb
 Unit Weight: 115 lb

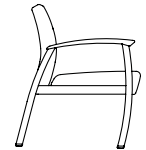
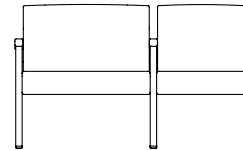

KOT20IBLU with Urethane Arm Caps

COM	Dillon/Carson	A ₅	B ₆	C ₇	D ₈	E ₉	F ₁₀	G ₁₁	H ₁₂	I ₁₃
2879	2899	3009	3089	3179	3319	3479	3569	3779	4029	4269

KOT20IBR - 2 Seat Right 29.5" Bariatric Guest Chair with Intervening Arm

Dimensions

Overall			Seat		
W	D	H	W	D	H
58	29.5	33.25	20.75	19.5	18.25
			Back H	Arm H	
			15	25.75	

COM: 3.5 yds
 Wt Cap: 1000 lb
 Unit Weight: 115 lb

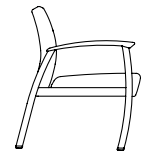
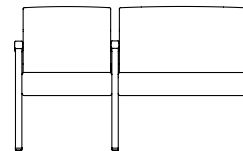

KOT20IBRU with Urethane Arm Caps

COM	Dillon/Carson	A ₅	B ₆	C ₇	D ₈	E ₉	F ₁₀	G ₁₁	H ₁₂	I ₁₃
2879	2899	3009	3089	3179	3319	3479	3569	3779	4029	4269

KOT30I - 3 Seat Guest Chair with Intervening Arms

Dimensions

Overall			Seat		
W	D	H	W	D	H
69.5	29.5	33.25	20.75	19.5	18.25
			Back H	Arm H	
			15	25.75	

COM: 5.5 yds
 Wt Cap: 1000 lb
 Unit Weight: 159 lb

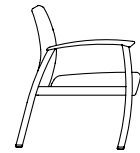
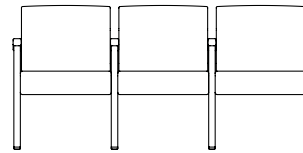

KOT30IU with Urethane Arm Caps

COM	Dillon/Carson	A ₅	B ₆	C ₇	D ₈	E ₉	F ₁₀	G ₁₁	H ₁₂	I ₁₃
3389	3429	3569	3659	3799	3989	4199	4259	4569	4899	5269

KOT30IBC - 3 Seat Center 29.5" Bariatric Guest Chair with Intervening Arms

Dimensions

Overall			Seat		
W	D	H	W	D	H
78.25	29.5	33.25	20.75	19.5	18.25
			Back H	Arm H	
			15	25.75	

COM: 4.5 yds
 Wt Cap: 1000 lb
 Unit Weight: 154 lb

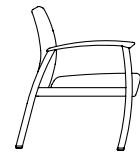
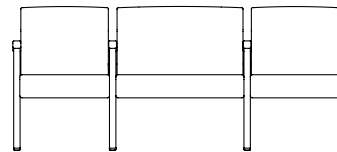

KOT30IBCU with Urethane Arm Caps

COM	Dillon/Carson	A ₅	B ₆	C ₇	D ₈	E ₉	F ₁₀	G ₁₁	H ₁₂	I ₁₃
3919	3989	4119	4249	4459	4649	4789	4939	5029	5399	5799

KOT30IBL - 3 Seat Left 29.5" Bariatric Guest Chair with Intervening Arms

Dimensions

Overall			Seat		
W	D	H	W	D	H
78.25	29.5	33.25	20.75	19.5	18.25
			Back H	Arm H	
			15	25.75	

COM: 4.5 yds
 Wt Cap: 1000 lb
 Unit Weight: 154 lb

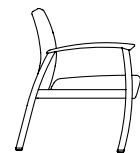
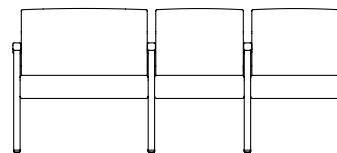

KOT30IBLU with Urethane Arm Caps

COM	Dillon/Carson	A ₅	B ₆	C ₇	D ₈	E ₉	F ₁₀	G ₁₁	H ₁₂	I ₁₃
3919	3989	4119	4249	4459	4649	4789	4939	5029	5399	5799

KOT30IBR - 3 Seat Right 29.5" Bariatric Guest Chair with Intervening Arms

Dimensions

Overall			Seat		
W	D	H	W	D	H
78.25	29.5	33.25	20.75	19.5	18.25
			Back H	Arm H	
			15	25.75	

COM: 4.5 yds
 Wt Cap: 1000 lb
 Unit Weight: 154 lb

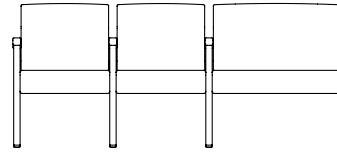

KOT30IBRU with Urethane Arm Caps

COM	Dillon/Carson	A5	B6	C7	D8	E9	F10	G11	H12	I13
3919	3989	4119	4249	4459	4649	4789	4939	5029	5399	5799

KOT00 - K-Series Ottoman

Dimensions

Overall		
W	D	H
19	18.5	12

COM: 1 yds
 Unit Weight: 12 lb

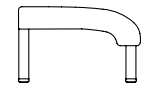
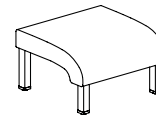

Pricing

COM	Dillon/Carson	A5	B6	C7	D8	E9	F10	G11	H12	I13
909	919	959	989	1019	1089	1139	1169	1189	1269	1339

KTC07 - Corner Ganging Table

Dimensions	Overall			Unit Weight: 32 lb	Price 1119
	W	D	H		
	37	16	15		

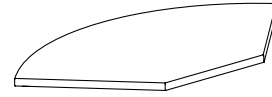

KTE07L - Left End Ganging Table (facing)

Dimensions	Overall			Unit Weight: 32 lb	Price 909
	W	D	H		
	15.5	20	15		

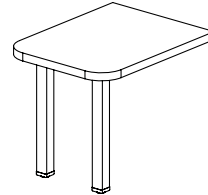

KTE07R - Right End Ganging Table (facing)

Dimensions	Overall			Unit Weight: 32 lb	Price 909
	W	D	H		
	15.5	20	15		

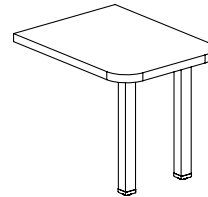

KTI07 - Intervening Ganging Table

Dimensions	Overall			Unit Weight: 17 lb	Price 769
	W	D	H		
	15.5	20	15		

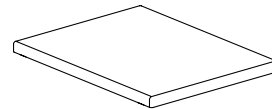

PT - Undermount Power

Dimensions	Overall			Unit Weight: 2 lb	Price 269
	W	D	H		
	9	12	2.25		

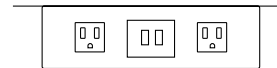

GANG BRKT KOT - Ganging Bracket

Dimensions	Overall			Unit Weight: 4 lb	Price 79
	W	D	H		
	11	0.25	3.5		

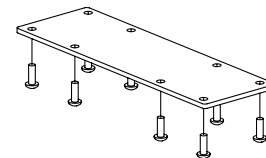

To Order, Specify

- Model Number
- Finish

KOT2020 - K-Series 20 x 20 End Table

Dimensions	Overall			Unit Weight: 29 lb	Price 949
	W	D	H		
	20	20	21.25		

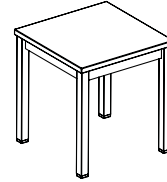

KOT2420 - K-Series 24 x 20 End Table

Dimensions	Overall			Unit Weight: 32 lb	Price 959
	W	D	H		
	24	20	21.25		

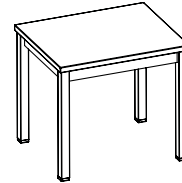

KOT3636 - K-Series 36 x 36 Magazine Table

Dimensions	Overall			Unit Weight: 66 lb	Price 1389
	W	D	H		
	36	36	16.25		

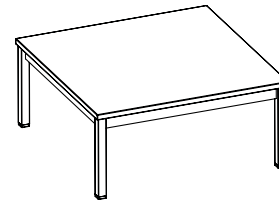

KOT4820 - K-Series 48 x 20 Magazine Table

Dimensions	Overall			Unit Weight: 52 lb	Price 1179
	W	D	H		
	48	20	16.25		

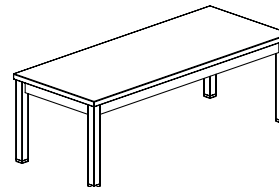

KOT24R - K-Series 24" Round Occasional Table

Dimensions	Overall			Unit Weight: 43 lb	Price 989
	W	D	H		
	24	24	21		

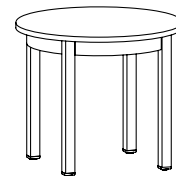

KOT36R - K-Series 36" Round Occasional Table

Dimensions	Overall			Unit Weight: 63 lb	Price 1249
	W	D	H		
	36	36	16		

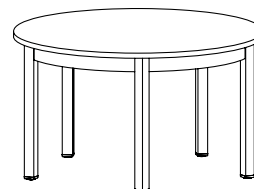

To Order, Specify

- Model Number
- Tabletop Finish
- Leg/skirt Finish



General Product Information

- Passive Flex Back
- Seat clean-out
- Wall-saver leg design
- Adjustable glides
- 16 gauge steel frame
- Arms connected by heavy steel rails
- Molded seat foam on 21" seats
- Back foam: 1.7 density foam that meets CAL 117 Fire Standards
- Comfort webbing in seats
- Field replaceable components

To Order, Specify

- Model Number
- Textile
- Finish
- Options

Available Options

FRAME OPTIONS *See pg 2 for finishes*
 *Standard in 540 Pewter finish

ARM CAP OPTIONS *See pg 2 for finishes*

- U Urethane Standard on specified models
- J Solid Surface Standard on specified models

ADDITIONAL FEATURES & OPTIONS

- CAL CAL TB133 *See pg 9*
- Z Multi Cover *Use Pricing for Highest Grade*
- MB Moisture Barrier *See pg 11*

KAM10HIP - Hip Chair

Dimensions

Overall			Seat		
W	D	H	W	D	H
24.5	31	39.25	20.75	22	22.75
			Back H	Arm H	
			16	31.5	

COM: 2 yds
 Wt Cap: 550 lb
 Unit Weight: 58 lb

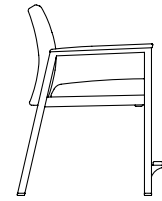
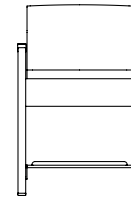

KAM10HIPU with Urethane Arm Caps

COM	Dillon	Carson	A ₅	B ₆	C ₇	D ₈	E ₉	F ₁₀	G ₁₁	H ₁₂	I ₁₃
1969	1979	2039	2069	2109	2199	2249	2329	2479	2629	2769	

KAM10HIPJ with Solid Surface Arm Caps (Add \$50 List per arm cap for Group 2 solid surface finish)

COM	Dillon	Carson	A ₅	B ₆	C ₇	D ₈	E ₉	F ₁₀	G ₁₁	H ₁₂	I ₁₃
2559	2569	2619	2649	2689	2799	2839	2899	3079	3289	3419	

KOT10HIP - Hip Chair

Dimensions

Overall			Seat		
W	D	H	W	D	H
24.5	29.5	39.25	20.75	19.5	24.25
			Back H	Arm H	
			15	31.75	

COM: 2 yds
 Wt Cap: 550 lb
 Unit Weight: 61.5 lb

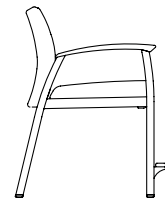
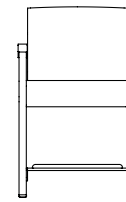

KOT10HIPU with Urethane Arm Caps

COM	Dillon	Carson	A ₅	B ₆	C ₇	D ₈	E ₉	F ₁₀	G ₁₁	H ₁₂	I ₁₃
1969	1979	2039	2069	2109	2199	2249	2329	2479	2629	2769	

KAM10BHIP - Bariatric Hip Chair

Dimensions

Overall			Seat		
W	D	H	W	D	H
33.5	31	39.25	29.5	22	22.75
			Back H	Arm H	
			16	31.5	

COM: 3 yds
 Wt Cap: 750 lb
 Unit Weight: 78 lb

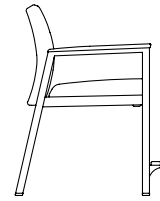
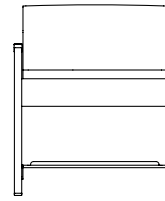

KAM10BHIPU with Urethane Arm Caps

COM	Dillon	Carson	A ₅	B ₆	C ₇	D ₈	E ₉	F ₁₀	G ₁₁	H ₁₂	I ₁₃
2359	2399	2429	2469	2549	2709	2819	2869	3089	3299	3479	

KAM10BHIPJ with Solid Surface Arm Caps (Add \$50 List per arm cap for Group 2 solid surface finish)

COM	Dillon	Carson	A ₅	B ₆	C ₇	D ₈	E ₉	F ₁₀	G ₁₁	H ₁₂	I ₁₃
2939	2999	3029	3069	3129	3309	3399	3459	3669	3899	4079	

KOT10BHIP - Bariatric Hip Chair

Dimensions

Overall			Seat		
W	D	H	W	D	H
33.5	29.5	39.25	29.5	19.5	24.25
			Back H	Arm H	
			15	31.75	

COM: 3 yds
 Wt Cap: 750 lb
 Unit Weight: 81.5 lb

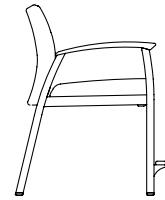
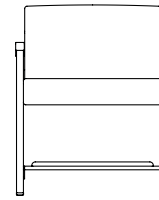

KOT10BHIPU with Urethane Arm Caps

COM	Dillon	Carson	A ₅	B ₆	C ₇	D ₈	E ₉	F ₁₀	G ₁₁	H ₁₂	I ₁₃
2359	2399	2429	2469	2549	2709	2819	2869	3089	3299	3479	



General Product Information

- Passive Flex Back
- Seat clean-out
- Wall-saver leg design
- Adjustable glides
- 16 gauge steel frame
- Arms connected by heavy steel rails
- Seat foam: 2.8 high resilience density foam that meets CAL 117 Fire Standards
- Back foam: 1.7 density foam that meets CAL 117 Fire Standards
- Comfort webbing in seats
- Field replaceable components

To Order, Specify

- Model Number
- Textile
- Finish
- Options

Available Options

<p>FRAME OPTIONS <i>See pg 2 for finishes</i> <i>*Standard in 540 Pewter finish</i></p>		<p>ADDITIONAL FEATURES & OPTIONS</p>	
<p>ARM CAP OPTIONS <i>See pg 2 for finishes</i></p>		CAL	CAL TB133 <i>See pg 9</i>
U	Urethane <i>Standard on specified models</i>	Z	Multi Cover <i>Use Pricing for Highest Grade</i>
J	Solid Surface <i>Standard on specified models</i>	MB	Moisture Barrier <i>See pg 11</i>

KAL12 - Lounge Chair

Dimensions

Overall			Seat		
W	D	H	W	D	H
27	30.5	34.5	24	20.5	19
			Back H	Arm H	
			16	25.5	

COM: 2.75 yds
 Wt Cap: 550 lb
 Unit Weight: 55.3 lb

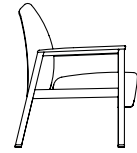
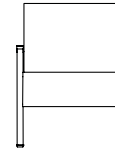

KAL12U with Urethane Arm Caps

COM	Dillon	Carson	A ₅	B ₆	C ₇	D ₈	E ₉	F ₁₀	G ₁₁	H ₁₂	I ₁₃
1969	1999	2029	2089	2139	2229	2339	2469	2699	2839	2949	

KAL12J with Solid Surface Arm Caps (Add \$50 List per arm cap for Group 2 solid surface finish)

COM	Dillon	Carson	A ₅	B ₆	C ₇	D ₈	E ₉	F ₁₀	G ₁₁	H ₁₂	I ₁₃
2369	2399	2429	2489	2539	2629	2739	2869	3099	3269	3419	

KAL12B - Bariatric Lounge Chair

Dimensions

Overall			Seat		
W	D	H	W	D	H
33	30.5	34.5	30	20.5	19
			Back H	Arm H	
			16	25.5	

COM: 2.9 yds
 Wt Cap: 750 lb
 Unit Weight: 62.7 lb

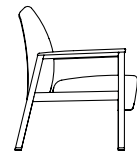
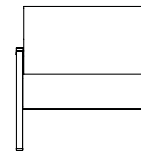

KAL12BU with Urethane Arm Caps

COM	Dillon	Carson	A ₅	B ₆	C ₇	D ₈	E ₉	F ₁₀	G ₁₁	H ₁₂	I ₁₃
2199	2219	2259	2339	2449	2559	2689	2749	3119	3289	3529	

KAL12BJ with Solid Surface Arm Caps (Add \$50 List per arm cap for Group 2 solid surface finish)

COM	Dillon	Carson	A ₅	B ₆	C ₇	D ₈	E ₉	F ₁₀	G ₁₁	H ₁₂	I ₁₃
2599	2619	2659	2739	2849	2959	3089	3149	3519	3699	3869	

KAL24 - 2 Seat Lounge Chair

Dimensions

Overall			Seat		
W	D	H	W	D	H
51.25	30.5	34.5	48	20.5	19
			Back H	Arm H	
			16	25.5	

COM: 3.87 yds
 Wt Cap: 750 lb
 Unit Weight: 87.3 lb

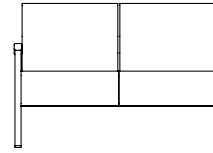

KAL24U with Urethane Arm Caps

COM	Dillon	Carson	A ₅	B ₆	C ₇	D ₈	E ₉	F ₁₀	G ₁₁	H ₁₂	I ₁₃
2799	2839	2919	3009	3129	3269	3409	3529	4019	4349	4599	

KAL24J with Solid Surface Arm Caps (Add \$50 List per arm cap for Group 2 solid surface finish)

COM	Dillon	Carson	A ₅	B ₆	C ₇	D ₈	E ₉	F ₁₀	G ₁₁	H ₁₂	I ₁₃
3199	3239	3319	3409	3529	3669	3809	3929	4419	4549	4669	

KAL24I - 2 Seat Lounge Chair with Intervening Arm

Dimensions

Overall			Seat		
W	D	H	W	D	H
51.25	30.5	34.5	24	20.5	19
			Back H	Arm H	
			16	25.5	

COM: 4.173 yds
 Wt Cap: 1000 lb
 Unit Weight: 101 lb

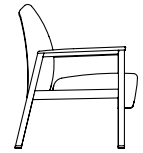
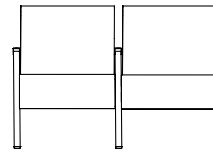

KAL24IU with Urethane Arm Caps

COM	Dillon	Carson	A ₅	B ₆	C ₇	D ₈	E ₉	F ₁₀	G ₁₁	H ₁₂	I ₁₃
3519	3619	3699	3869	4059	4289	4549	4699	4789	4999	5269	

KAL24IJ with Solid Surface Arm Caps (Add \$50 List per arm cap for Group 2 solid surface finish)

COM	Dillon	Carson	A ₅	B ₆	C ₇	D ₈	E ₉	F ₁₀	G ₁₁	H ₁₂	I ₁₃
4119	4219	4299	4469	4659	4889	5149	5299	5389	5839	6289	

KAL24IBL - 2 Seat Left 30" Bariatric Lounge Chair with Intervening Arm

Dimensions

Overall			Seat		
W	D	H	W	D	H
58.5	30.5	34.5	30	20.5	19
			Back H	Arm H	
			16	25.5	

COM: 4.88 yds
 Wt Cap: 1000 lb
 Unit Weight: 111 lb

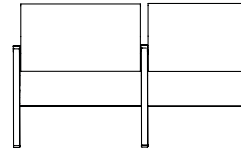

KAL24IBLU with Urethane Arm Caps

COM	Dillon	Carson	A ₅	B ₆	C ₇	D ₈	E ₉	F ₁₀	G ₁₁	H ₁₂	I ₁₃
3469	3519	3609	3699	3849	4019	4199	4329	4789	5079	5399	

KAL24IBLJ with Solid Surface Arm Caps (Add \$50 List per arm cap for Group 2 solid surface finish)

COM	Dillon	Carson	A ₅	B ₆	C ₇	D ₈	E ₉	F ₁₀	G ₁₁	H ₁₂	I ₁₃
4069	4119	4209	4299	4449	4619	4799	4929	5389	5839	6299	

KAL24IBR - 2 Seat Right 30" Bariatric Lounge Chair with Intervening Arm

Dimensions

Overall			Seat		
W	D	H	W	D	H
58.5	30.5	34.5	30	20.5	19
			Back H	Arm H	
			16	25.5	

COM: 4.88 yds
 Wt Cap: 1000 lb
 Unit Weight: 111 lb

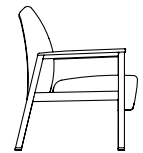
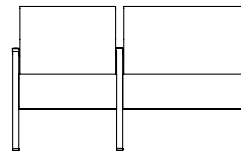

KAL24IBRU with Urethane Arm Caps

COM	Dillon	Carson	A ₅	B ₆	C ₇	D ₈	E ₉	F ₁₀	G ₁₁	H ₁₂	I ₁₃
3469	3519	3609	3699	3849	4019	4199	4329	4789	5079	5399	

KAL24IBRJ with Solid Surface Arm Caps (Add \$50 List per arm cap for Group 2 solid surface finish)

COM	Dillon	Carson	A ₅	B ₆	C ₇	D ₈	E ₉	F ₁₀	G ₁₁	H ₁₂	I ₁₃
4069	4119	4209	4299	4449	4619	4799	4929	5389	5839	6299	

KAL36I - 3 Seat Lounge Chair with Intervening Arms

Dimensions

<u>Overall</u>			<u>Seat</u>		
W	D	H	W	D	H
78.25	30.5	34.5	24	20.5	19
			Back H	Arm H	
			16	25.5	

COM: 5.65 yds
Wt Cap: 1000 lb
Unit Weight: 143 lb

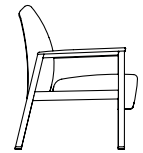
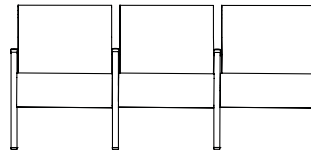

KAL36IU with Urethane Arm Caps

COM	<i>Dillon/Carson</i>	A ₅	B ₆	C ₇	D ₈	E ₉	F ₁₀	G ₁₁	H ₁₂	I ₁₃
4709	4819	4879	5069	5269	5549	5779	5999	6159	6529	6839

KAL36IJ with Solid Surface Arm Caps (Add \$50 List per arm cap for Group 2 solid surface finish)

COM	<i>Dillon/Carson</i>	A ₅	B ₆	C ₇	D ₈	E ₉	F ₁₀	G ₁₁	H ₁₂	I ₁₃
5509	5619	5679	5869	6069	6349	6579	6799	6959	7259	7549

KAL36IBC - 3 Seat Center 30" Bariatric Lounge Chair with Intervening Arms

Dimensions

<u>Overall</u>			<u>Seat</u>		
W	D	H	W	D	H
84.25	30.5	34.5	30	20.5	19
			Back H	Arm H	
			16	25.5	

COM: 5.95 yds
Wt Cap: 1000 lb
Unit Weight: 153.2 lb

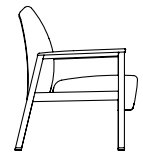
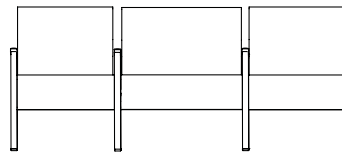

KAL36BCU with Urethane Arm Caps

COM	<i>Dillon/Carson</i>	A ₅	B ₆	C ₇	D ₈	E ₉	F ₁₀	G ₁₁	H ₁₂	I ₁₃
4559	4649	4759	4889	5099	5349	5619	5819	6159	6699	7099

KAL36BCJ with Solid Surface Arm Caps (Add \$50 List per arm cap for Group 2 solid surface finish)

COM	<i>Dillon/Carson</i>	A ₅	B ₆	C ₇	D ₈	E ₉	F ₁₀	G ₁₁	H ₁₂	I ₁₃
5359	5449	5559	5689	5899	6149	6419	6619	6959	7399	7849

KAL36IBL - 3 Seat Left 30" Bariatric Lounge Chair with Intervening Arms

Dimensions

Overall			Seat		
W	D	H	W	D	H
84.25	30.5	34.5	30	20.5	19
			Back H	Arm H	
			16	25.5	

COM: 5.95 yds
 Wt Cap: 1000 lb
 Unit Weight: 153.2 lb

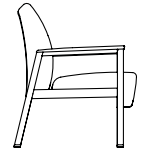
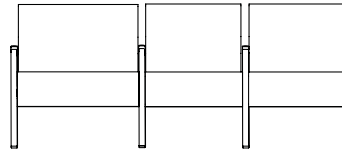

KAL36IBLU with Urethane Arm Caps

COM	Dillon	Carson	A ₅	B ₆	C ₇	D ₈	E ₉	F ₁₀	G ₁₁	H ₁₂	I ₁₃
4559	4649	4759	4889	5099	5349	5619	5819	6159	6699	7099	

KAL36IBLJ with Solid Surface Arm Caps (Add \$50 List per arm cap for Group 2 solid surface finish)

COM	Dillon	Carson	A ₅	B ₆	C ₇	D ₈	E ₉	F ₁₀	G ₁₁	H ₁₂	I ₁₃
5359	5449	5559	5689	5899	6149	6419	6619	6959	7399	7849	

KAL36IBR - 3 Seat Right 30" Bariatric Lounge Chair with Intervening Arms

Dimensions

Overall			Seat		
W	D	H	W	D	H
84.25	30.5	34.5	30	20.5	19
			Back H	Arm H	
			16	25.5	

COM: 5.95 yds
 Wt Cap: 1000 lb
 Unit Weight: 153.2 lb

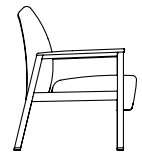
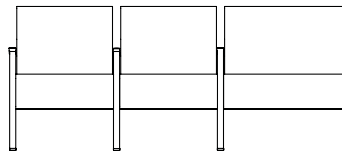

KAL36IBRU with Urethane Arm Caps

COM	Dillon	Carson	A ₅	B ₆	C ₇	D ₈	E ₉	F ₁₀	G ₁₁	H ₁₂	I ₁₃
4559	4649	4759	4889	5099	5349	5619	5819	6159	6699	7099	

KAL36IBRJ with Solid Surface Arm Caps (Add \$50 List per arm cap for Group 2 solid surface finish)

COM	Dillon	Carson	A ₅	B ₆	C ₇	D ₈	E ₉	F ₁₀	G ₁₁	H ₁₂	I ₁₃
5359	5449	5559	5689	5899	6149	6419	6619	6959	7399	7849	



General Product Information

- Passive Flex Back
- Seat clean-out
- Wall-saver leg design
- Adjustable glides
- 16 gauge steel frame
- Arms connected by heavy steel rails
- Seat foam: 2.8 high resilience density foam that meets CAL 117 Fire Standards
- Back foam: 1.7 density foam that meets CAL 117 Fire Standards
- Comfort webbing in seats
- Field replaceable components

To Order, Specify

- Model Number
- Textile
- Finish
- Options

Available Options

<p>FRAME OPTIONS <i>See pg 2 for finishes</i> <i>*Standard in 540 Pewter finish</i></p> <p>ARM CAP OPTIONS <i>See pg 2 for finishes</i></p> <p>U Urethane Standard</p>	<p>ADDITIONAL FEATURES & OPTIONS</p> <p>CAL CAL TB133 See pg 9</p> <p>Z Multi Cover Use Pricing for Highest Grade</p> <p>MB Moisture Barrier See pg 11</p>
--	--

KOL12 - Lounge Chair

Dimensions

Overall			Seat		
W	D	H	W	D	H
27	30	35	24	20.5	19
		Back H			Arm H
		16			25.5

COM: 2.75 yds
 Wt Cap: 550 lb
 Unit Weight: 56.3 lb

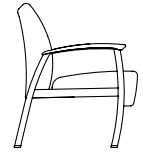
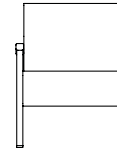

KOL12U with Urethane Arm Caps

COM	Dillon/Carson	A ₅	B ₆	C ₇	D ₈	E ₉	F ₁₀	G ₁₁	H ₁₂	I ₁₃
1969	1999	2029	2089	2139	2229	2339	2469	2699	2889	3049

KOL12B - Bariatric Lounge Chair

Dimensions

Overall			Seat		
W	D	H	W	D	H
33	30	35	30	20.5	19
		Back H			Arm H
		16			25.5

COM: 2.9 yds
 Wt Cap: 750 lb
 Unit Weight: 63.5 lb

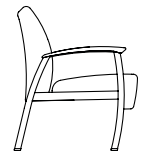
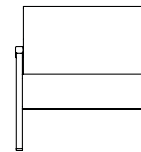

KOL12BU with Urethane Arm Caps

COM	Dillon/Carson	A ₅	B ₆	C ₇	D ₈	E ₉	F ₁₀	G ₁₁	H ₁₂	I ₁₃
2199	2219	2259	2339	2449	2559	2689	2749	3119	3319	3529

KOL24 - 2 Seat Lounge Chair

Dimensions

Overall			Seat		
W	D	H	W	D	H
51.25	30	35	48	20.5	19
		Back H			Arm H
		16			25.5

COM: 3.87 yds
 Wt Cap: 750 lb
 Unit Weight: 89 lb

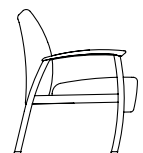
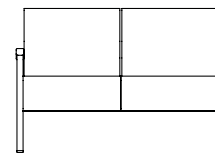

KOL24U with Urethane Arm Caps

COM	Dillon/Carson	A ₅	B ₆	C ₇	D ₈	E ₉	F ₁₀	G ₁₁	H ₁₂	I ₁₃
2799	2839	2919	3009	3129	3269	3409	3529	4019	4319	4599

KOL24I - 2 Seat Lounge Chair with Intervening Arm

Dimensions

Overall			Seat		
W	D	H	W	D	H
51.25	30	35	24	20.5	19
		Back H			Arm H
		16			25.5

COM: 4.173 yds
 Wt Cap: 1000 lb
 Unit Weight: 101 lb

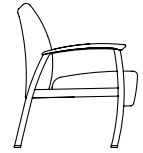
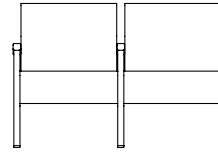

KOL24IU with Urethane Arm Caps

COM	Dillon/Carson	A ₅	B ₆	C ₇	D ₈	E ₉	F ₁₀	G ₁₁	H ₁₂	I ₁₃
3519	3619	3699	3869	4059	4289	4549	4699	4789	5049	5319

KOL24IBL - 2 Seat Left 30" Bariatric Lounge Chair with Intervening Arm

Dimensions

Overall			Seat		
W	D	H	W	D	H
58.5	30	35	30	20.5	19
		Back H			Arm H
		16			25.5

COM: 4.88 yds
 Wt Cap: 1000 lb
 Unit Weight: 110.5 lb

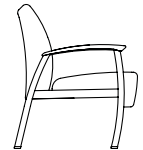
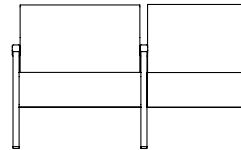

KOL24IBLU with Urethane Arm Caps

COM	Dillon/Carson	A ₅	B ₆	C ₇	D ₈	E ₉	F ₁₀	G ₁₁	H ₁₂	I ₁₃
3469	3519	3609	3699	3849	4019	4199	4329	4789	5129	5529

KOL24IBR - 2 Seat Right 30" Bariatric Lounge Chair with Intervening Arm

Dimensions

Overall			Seat		
W	D	H	W	D	H
58.5	30	35	30	20.5	19
		Back H			Arm H
		16			25.5

COM: 4.88 yds
 Wt Cap: 1000 lb
 Unit Weight: 110.5 lb

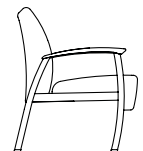
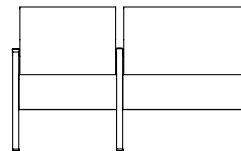

KOL24IBRU with Urethane Arm Caps

COM	Dillon/Carson	A ₅	B ₆	C ₇	D ₈	E ₉	F ₁₀	G ₁₁	H ₁₂	I ₁₃
3469	3519	3609	3699	3849	4019	4199	4329	4789	5129	5529

KOL36I - 3 Seat Lounge Chair with Intervening Arms

Dimensions

Overall			Seat		
W	D	H	W	D	H
78.25	30	35	24	20.5	19
		Back H			Arm H
		16			25.5

COM: 5.65 yds
 Wt Cap: 1000 lb
 Unit Weight: 143 lb

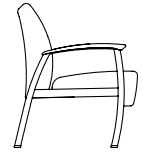
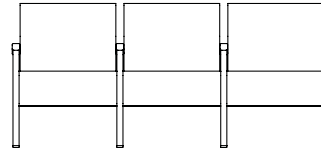

KOL36IU with Urethane Arm Caps

COM	Dillon/Carson	A ₅	B ₆	C ₇	D ₈	E ₉	F ₁₀	G ₁₁	H ₁₂	I ₁₃
4709	4819	4879	5069	5269	5549	5779	5999	6159	6579	6969

KOL36IBC - 3 Seat Center 30" Bariatric Lounge Chair with Intervening Arms

Dimensions

Overall			Seat		
W	D	H	W	D	H
84.25	30	35	30	20.5	19
		Back H			Arm H
		16			25.5

COM: 5.95 yds
 Wt Cap: 1000 lb
 Unit Weight: 153 lb

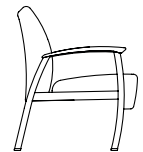
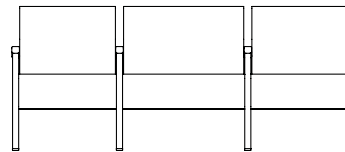

KOL36IBCU with Urethane Arm Caps

COM	Dillon/Carson	A ₅	B ₆	C ₇	D ₈	E ₉	F ₁₀	G ₁₁	H ₁₂	I ₁₃
4559	4649	4759	4889	5099	5349	5619	5819	6159	6699	7099

KOL36IBL - 3 Seat Left 30" Bariatric Lounge Chair with Intervening Arms

Dimensions

Overall			Seat		
W	D	H	W	D	H
84.25	30	35	30	20.5	19
		Back H			Arm H
		16			25.5

COM: 5.95 yds
 Wt Cap: 1000 lb
 Unit Weight: 153 lb

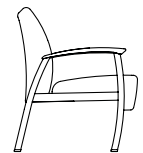
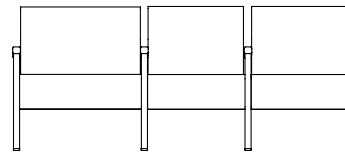

KOL36IBLU with Urethane Arm Caps

COM	Dillon/Carson	A ₅	B ₆	C ₇	D ₈	E ₉	F ₁₀	G ₁₁	H ₁₂	I ₁₃
4559	4649	4759	4889	5099	5349	5619	5819	6159	6699	7099

KOL36IBR - 3 Seat Right 30" Bariatric Lounge Chair with Intervening Arms

Dimensions

Overall			Seat		
W	D	H	W	D	H
84.25	30	35	30	20.5	19
			Back H	Arm H	
			16	25.5	

COM: 5.95 yds
 Wt Cap: 1000 lb
 Unit Weight: 153 lb

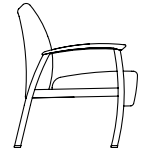
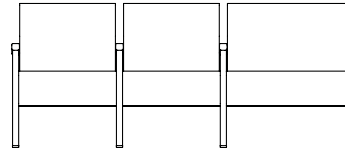

KOL36IBRU with Urethane Arm Caps

COM	Dillon/Carson	A ₅	B ₆	C ₇	D ₈	E ₉	F ₁₀	G ₁₁	H ₁₂	I ₁₃
4559	4649	4759	4889	5099	5349	5619	5819	6159	6699	7099



General Product Information

- Standard with fully upholstered arms & metal feet
- Passive Flex Back
- Seat clean-out
- Wall-saver leg design
- All interior joints are CNC cut/puzzle-jointed, corner blocked, screwed, & glued together
- Commercial grade double-walled plywood interior frame
- Arms connected by 14 gauge steel support tubes
- Seat foam: 2.8 high resilience density foam that meets CAL 117 Fire Standards
- Back foam: 1.7 density foam that meets CAL 117 Fire Standards
- Comfort webbing in seats and sinuous springs in backs
- Field replaceable components

To Order, Specify

- Model Number
- Textile
- Finish
- Options

Available Options

ARM CAP OPTIONS *See pg 2 for finishes*

		2 Arms	3 Arms	4 Arms
U	Urethane	178	267	356
J1	Solid Surface - Group 1	618	927	1236
J2	Solid Surface - Group 2	818	1227	1636
F	Fully Upholstered Arms	Standard		

FEET OPTIONS *See pg 2 for finishes*

MF	Metal Feet with Adjustable Glides	Standard
----	-----------------------------------	----------

**Standard in S40 Pewter finish*

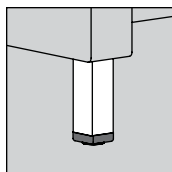

POWER OPTIONS

PU8	Power ¹ (USB-A/USB-C/Grounded Receptacle)	209
-----	--	-----

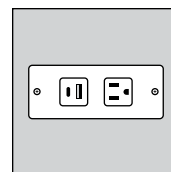

ADDITIONAL FEATURES & OPTIONS

CAL	CAL TB133	See pg 9
Z	Multi Cover	Use Pricing for Highest Grade
MB	Moisture Barrier	See pg 11

¹Installed on outside of left (facing) arm

KMU10 - Lounge Chair

Dimensions

Overall			Seat		
W	D	H	W	D	H
28.25	29	32.75	22	20	18.25
			Back H	Arm H	
			15	25.25	

COM: 3.8 yd
 Wt Cap: 550 lb
 Unit Weight: 77 lb

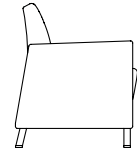
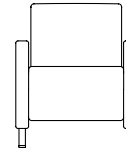

KMU10 Standard with Fully Upholstered Arms (Refer to pg 48 for arm cap options)

COM	Dillon/Carson	A ₅	B ₆	C ₇	D ₈	E ₉	F ₁₀	G ₁₁	H ₁₂	I ₁₃
2059	2129	2199	2339	2449	2629	2759	2979	3479	3689	3949

KMU10B - Bariatric Lounge Chair

Dimensions

Overall			Seat		
W	D	H	W	D	H
34.75	29	32.75	29.5	20	18.25
			Back H	Arm H	
			15	25.25	

COM: 5.4 yd
 Wt Cap: 750 lb
 Unit Weight: 101 lb

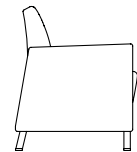
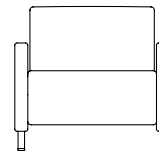

KMU10B Standard with Fully Upholstered Arms (Refer to pg 48 for arm cap options)

COM	Dillon/Carson	A ₅	B ₆	C ₇	D ₈	E ₉	F ₁₀	G ₁₁	H ₁₂	I ₁₃
2419	2499	2589	2669	2809	2929	3049	3309	3929	4289	4689

KMU20 - Lounge Loveseat

Dimensions

Overall			Seat		
W	D	H	W	D	H
50.25	29	32.75	44	20	18.25
			Back H	Arm H	
			15	25.25	

COM: 5.4 yd
 Wt Cap: 750 lb
 Unit Weight: 121 lb

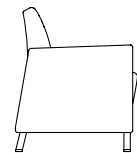
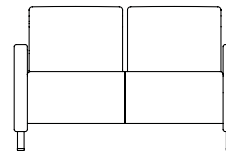

KMU20 Standard with Fully Upholstered Arms (Refer to pg 48 for arm cap options)

COM	Dillon/Carson	A ₅	B ₆	C ₇	D ₈	E ₉	F ₁₀	G ₁₁	H ₁₂	I ₁₃
2949	3059	3169	3349	3539	3779	3969	4309	5039	5269	5529

KMU20I - 2 Seat Lounge Chair with Intervening Arm

Dimensions

Overall			Seat		
W	D	H	W	D	H
52	29	32.75	22	20	18.25
			Back H	Arm H	
			15	25.25	

COM: 6.9 yd
 Wt Cap: 1000 lb
 Unit Weight: 141 lb

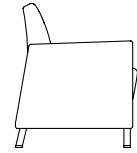
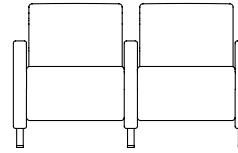

KMU20I Standard with Fully Upholstered Arms (Refer to pg 48 for arm cap options)

COM	Dillon/Carson	A ₅	B ₆	C ₇	D ₈	E ₉	F ₁₀	G ₁₁	H ₁₂	I ₁₃
3589	3729	3859	4059	4299	4549	4759	5179	5969	6199	6579

KMU20T - 2 Seat Lounge Chair with Intervening Table

Dimensions

Overall			Seat		
W	D	H	W	D	H
72	29	32.75	22	20	18.25
			Back H	Arm H	
			15	25.25	

COM: 6.1 yd
 Wt Cap: 750 lb
 Unit Weight: 155 lb

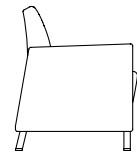
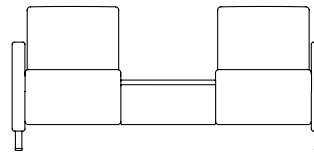

KMU20T Standard with Fully Upholstered Arms (Refer to pg 48 for arm cap options)

COM	Dillon/Carson	A ₅	B ₆	C ₇	D ₈	E ₉	F ₁₀	G ₁₁	H ₁₂	I ₁₃
4059	4189	4369	4549	4799	5079	5299	5759	6289	6849	7399

KMU20IT - 2 Seat Lounge Chair with Intervening Table & Intervening Arms

Dimensions

Overall			Seat		
W	D	H	W	D	H
77.5	29	32.75	22	20	20
			Back H	Arm H	
			15	25.25	

COM: 8 yd
 Wt Cap: 1000 lb
 Unit Weight: 182 lb

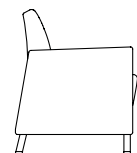
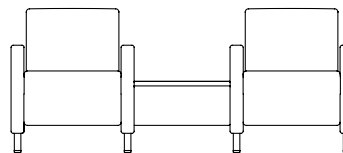

KMU20IT Standard with Fully Upholstered Arms (Refer to pg 48 for arm cap options)

COM	Dillon/Carson	A ₅	B ₆	C ₇	D ₈	E ₉	F ₁₀	G ₁₁	H ₁₂	I ₁₃
4599	4749	4959	5179	5469	5789	6039	6549	7229	7889	8549

KMU20IBL - 2 Seat Left 29.5" Bariatric Lounge Chair with Intervening Arm

Dimensions

Overall			Seat		
W	D	H	W	D	H
59.5	29	32.75	22	20	18.25
			Back H	Arm H	
			15	25.25	

COM: 7.1 yd
 Wt Cap: 1000 lb
 Unit Weight: 151 lb

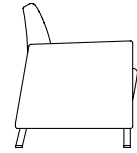
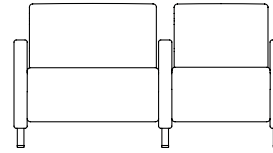

KMU20IBL Standard with Fully Upholstered Arms (Refer to pg 48 for arm cap options)

COM	Dillon/Carson	A ₅	B ₆	C ₇	D ₈	E ₉	F ₁₀	G ₁₁	H ₁₂	I ₁₃
3979	4089	4249	4439	4649	4929	5109	5479	6289	6839	7369

KMU20IBR - 2 Seat Right 29.5" Bariatric Lounge Chair with Intervening Arm

Dimensions

Overall			Seat		
W	D	H	W	D	H
59.5	29	32.75	29.5	20	18.25
			Back H	Arm H	
			15	25.25	

COM: 7.1 yd
 Wt Cap: 1000 lb
 Unit Weight: 151 lb

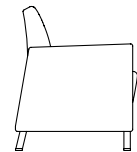
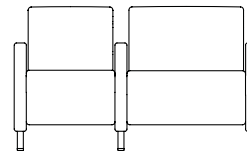

KMU20IBR Standard with Fully Upholstered Arms (Refer to pg 48 for arm cap options)

COM	Dillon/Carson	A ₅	B ₆	C ₇	D ₈	E ₉	F ₁₀	G ₁₁	H ₁₂	I ₁₃
3979	4089	4249	4439	4649	4929	5109	5479	6289	6839	7369

KMU30 - Lounge Sofa

Dimensions

Overall			Seat		
W	D	H	W	D	H
71.5	29	32.75	66.5	20	18.25
			Back H	Arm H	
			15	25.25	

COM: 7.1 yd
 Wt Cap: 750 lb
 Unit Weight: 154 lb

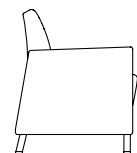
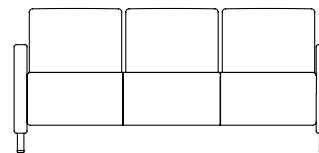

KMU30 Standard with Fully Upholstered Arms (Refer to pg 48 for arm cap options)

COM	Dillon/Carson	A ₅	B ₆	C ₇	D ₈	E ₉	F ₁₀	G ₁₁	H ₁₂	I ₁₃
3849	4019	4209	4399	4679	4969	5219	5699	6619	6969	7369

KMU30I - 3 Seat Lounge Chair with Intervening Arms

Dimensions

Overall			Seat		
W	D	H	W	D	H
76.5	29	32.75	22	20	18.25
			Back H	Arm H	
			15	25.25	

COM: 9.2 yd
 Wt Cap: 1000 lb
 Unit Weight: 197 lb

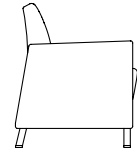
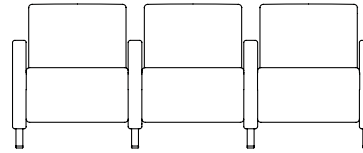

KMU30I Standard with Fully Upholstered Arms (Refer to pg 48 for arm cap options)

COM	Dillon/Carson	A ₅	B ₆	C ₇	D ₈	E ₉	F ₁₀	G ₁₁	H ₁₂	I ₁₃
5079	5269	5519	5769	6119	6489	6829	7419	8179	8679	9199

KMU30IBC - 3 Seat Center 29.5" Bariatric Lounge Chair with Intervening Arms

Dimensions

Overall			Seat		
W	D	H	W	D	H
84.25	29	32.75	29.5	20	18.25
			Back H	Arm H	
			15	25.25	

COM: 9.6 yd
 Wt Cap: 1000 lb
 Unit Weight: 206 lb

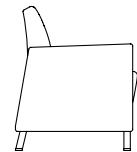
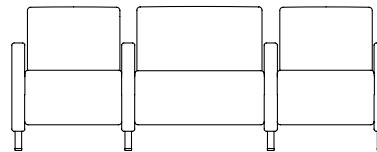

KMU30IBC Standard with Fully Upholstered Arms (Refer to pg 48 for arm cap options)

COM	Dillon/Carson	A ₅	B ₆	C ₇	D ₈	E ₉	F ₁₀	G ₁₁	H ₁₂	I ₁₃
5639	5789	6039	6259	6519	6879	7139	7739	8509	9199	9899

KMU30IBL - 3 Seat Left 29.5" Bariatric Lounge Chair with Intervening Arms

Dimensions

Overall			Seat		
W	D	H	W	D	H
84.25	29	32.75	29.5	20	18.25
			Back H	Arm H	
			15	25.25	

COM: 9.6 yd
 Wt Cap: 1000 lb
 Unit Weight: 206 lb

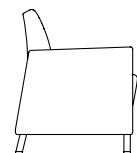
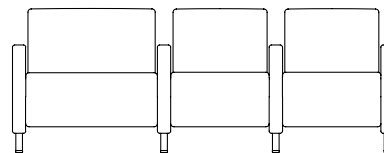

KMU30IBL Standard with Fully Upholstered Arms (Refer to pg 48 for arm cap options)

COM	Dillon/Carson	A ₅	B ₆	C ₇	D ₈	E ₉	F ₁₀	G ₁₁	H ₁₂	I ₁₃
5639	5789	6039	6259	6519	6879	7139	7739	8509	9199	9899

KMU30IBR - 3 Seat Right 29.5" Bariatric Lounge Chair with Intervening Arms

Dimensions

Overall			Seat		
W	D	H	W	D	H
84.25	29	32.75	29.5	20	18.25
			Back H	Arm H	
			15	25.5	

COM: 9.6 yd
 Wt Cap: 1000 lb
 Unit Weight: 206 lb

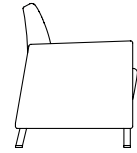
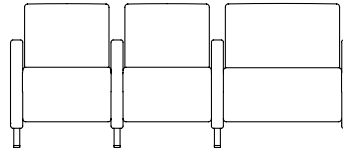

KMU30IBR Standard with Fully Upholstered Arms (Refer to pg 48 for arm cap options)

COM	Dillon/Carson	A ₅	B ₆	C ₇	D ₈	E ₉	F ₁₀	G ₁₁	H ₁₂	I ₁₃
5639	5789	6039	6259	6519	6879	7139	7739	8509	9199	9899



General Product Information

- Standard with fully upholstered arms & wood feet
- Passive Flex Back
- Seat clean-out
- Wall-saver leg design
- All interior joints are CNC cut/puzzle-jointed, corner blocked, screwed, & glued together
- Commercial grade double-walled plywood interior frame
- Arms connected by 14 gauge steel support tubes
- Seat foam: 2.8 high resilience density foam that meets CAL 117 Fire Standards
- Back foam: 1.7 density foam that meets CAL 117 Fire Standards
- Comfort webbing in seats and sinuous springs in backs
- Field replaceable components

To Order, Specify

- Model Number
- Textile
- Finish
- Options

Available Options

ARM CAP OPTIONS		<i>See pg 2 for finishes</i>		
		2 Arms	3 Arms	4 Arms
U	Urethane	178	267	356
J1	Solid Surface - Group 1	618	927	1236
J2	Solid Surface - Group 2	818	1227	1636
F	Fully Upholstered Arms	Standard		

FEET OPTIONS		<i>See pg 2 for finishes</i>	
			Standard
WF	Wood Feet		
MF	Metal Feet with Adjustable Glides		
	4 Metal Feet (Single Seat, Love Seat, Sofa)		109
	6 Metal Feet (2-Seat w/ Intervening Arms)		169
	8 Metal Feet (3-Seat w/ Intervening Arms)		229

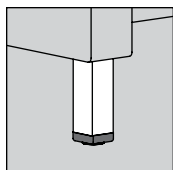

¹Installed on outside of left (facing) arm

POWER OPTIONS		
PU8	Power ¹ (USB-A/USB-C/Grounded Receptacle)	209

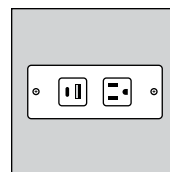

ADDITIONAL FEATURES & OPTIONS		
CAL	CAL TB133	See pg 9
Z	Multi Cover	Use Pricing for Highest Grade
MB	Moisture Barrier	See pg 11

KOU10 - Lounge Chair

Dimensions

Overall			Seat		
W	D	H	W	D	H
27.25	30	33.75	21.75	19	18
			Back H	Arm H	
			15.75	25	

COM: 4 yd
 Wt Cap: 550 lb
 Unit Weight: 82 lb

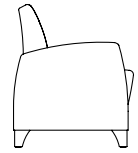
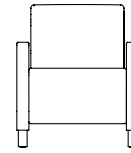

KOU10 Standard with Fully Upholstered Arms (Refer to pg 54 for arm cap options)

COM	Dillon/Carson	A ₅	B ₆	C ₇	D ₈	E ₉	F ₁₀	G ₁₁	H ₁₂	I ₁₃
2059	2129	2199	2339	2449	2629	2759	2979	3479	3699	3949

KOU10B - Bariatric Lounge Chair

Dimensions

Overall			Seat		
W	D	H	W	D	H
34.5	30	33.75	29.5	19	18
			Back H	Arm H	
			15.75	25	

COM: 4.5 yd
 Wt Cap: 750 lb
 Unit Weight: 102 lb

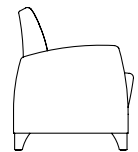
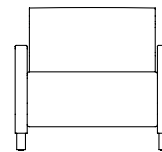

KOU10B Standard with Fully Upholstered Arms (Refer to pg 54 for arm cap options)

COM	Dillon/Carson	A ₅	B ₆	C ₇	D ₈	E ₉	F ₁₀	G ₁₁	H ₁₂	I ₁₃
2419	2499	2589	2669	2809	2929	3049	3309	3929	4199	4579

KOU20 - Lounge Loveseat

Dimensions

Overall			Seat		
W	D	H	W	D	H
49.75	30	33.75	44	19	18
			Back H	Arm H	
			15.75	25	

COM: 5.5 yd
 Wt Cap: 750 lb
 Unit Weight: 120 lb

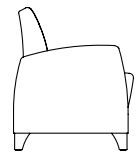
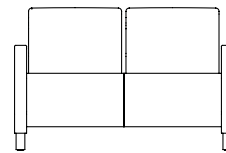

KOU20 Standard with Fully Upholstered Arms (Refer to pg 54 for arm cap options)

COM	Dillon/Carson	A ₅	B ₆	C ₇	D ₈	E ₉	F ₁₀	G ₁₁	H ₁₂	I ₁₃
2949	3059	3169	3349	3539	3779	3969	4309	5039	5529	5919

KOU20I - 2 Seat Lounge Chair with Intervening Arm

Dimensions

Overall			Seat		
W	D	H	W	D	H
51.75	30	33.75	21.75	19	18
			Back H	Arm H	
			15.75	25	

COM: 6.5 yd
 Wt Cap: 1000 lb
 Unit Weight: 140 lb

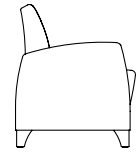
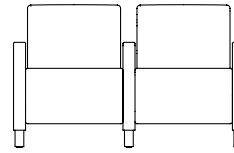

KOU20I Standard with Fully Upholstered Arms (Refer to pg 54 for arm cap options)

COM	Dillon/Carson	A ₅	B ₆	C ₇	D ₈	E ₉	F ₁₀	G ₁₁	H ₁₂	I ₁₃
3589	3729	3859	4059	4299	4549	4759	5179	5969	6449	6849

KOU20T - 2 Seat Lounge Chair with Intervening Table

Dimensions

Overall			Seat		
W	D	H	W	D	H
71.75	30	33.75	21.75	19	18
			Back H	Arm H	
			15.75	25	

COM: 5.4 yd
 Wt Cap: 750 lb
 Unit Weight: 155 lb

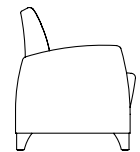
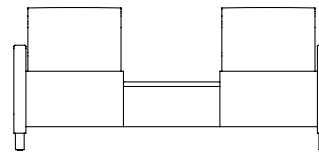

KOU20T Standard with Fully Upholstered Arms (Refer to pg 54 for arm cap options)

COM	Dillon/Carson	A ₅	B ₆	C ₇	D ₈	E ₉	F ₁₀	G ₁₁	H ₁₂	I ₁₃
4059	4189	4369	4549	4799	5079	5299	5759	6289	6699	7229

KOU20IT - 2 Seat Lounge Chair with Intervening Table & Intervening Arms

Dimensions

Overall			Seat		
W	D	H	W	D	H
76.25	30	33.75	21.75	19	18
			Back H	Arm H	
			15.75	25	

COM: 7 yd
 Wt Cap: 1000 lb
 Unit Weight: 180 lb

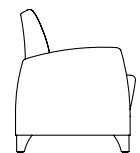
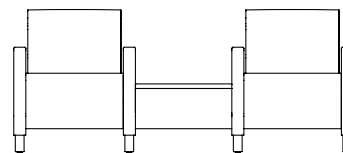

KOU20IT Standard with Fully Upholstered Arms (Refer to pg 54 for arm cap options)

COM	Dillon/Carson	A ₅	B ₆	C ₇	D ₈	E ₉	F ₁₀	G ₁₁	H ₁₂	I ₁₃
4599	4749	4959	5179	5469	5789	6039	6549	7229	7729	8299

KOU20IBL - 2 Seat Left 29.5" Bariatric Lounge Chair with Intervening Arm

Dimensions

Overall			Seat		
W	D	H	W	D	H
59.125	30	33.75	29.5	19	18
			Back H	Arm H	
			15.75	25	

COM: 7 yd
 Wt Cap: 1000 lb
 Unit Weight: 150 lb

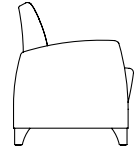
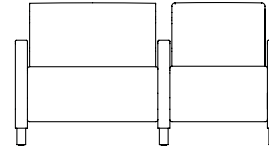

KOU20IBL Standard with Fully Upholstered Arms (Refer to pg 54 for arm cap options)

COM	Dillon/Carson	A ₅	B ₆	C ₇	D ₈	E ₉	F ₁₀	G ₁₁	H ₁₂	I ₁₃
3979	4089	4249	4439	4649	4929	5109	5479	6289	6699	7199

KOU20IBR - 2 Seat Right 29.5" Bariatric Lounge Chair with Intervening Arm

Dimensions

Overall			Seat		
W	D	H	W	D	H
59.125	30	33.75	29.5	19	18
			Back H	Arm H	
			15.75	25	

COM: 7 yd
 Wt Cap: 1000 lb
 Unit Weight: 150 lb

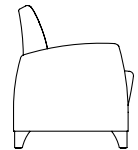
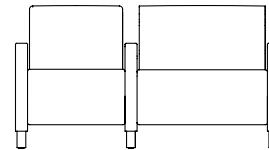

KOU20IBR Standard with Fully Upholstered Arms (Refer to pg 54 for arm cap options)

COM	Dillon/Carson	A ₅	B ₆	C ₇	D ₈	E ₉	F ₁₀	G ₁₁	H ₁₂	I ₁₃
3979	4089	4249	4439	4649	4929	5109	5479	6289	6699	7199

KOU30 - Lounge Sofa

Dimensions

Overall			Seat		
W	D	H	W	D	H
71.75	30	33.75	66.5	19	18
			Back H	Arm H	
			15.75	25	

COM: 7.5 yd
 Wt Cap: 750 lb
 Unit Weight: 155 lb

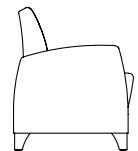
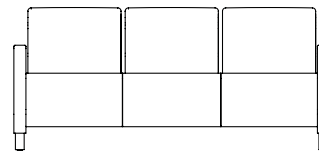

KOU30 Standard with Fully Upholstered Arms (Refer to pg 54 for arm cap options)

COM	Dillon/Carson	A ₅	B ₆	C ₇	D ₈	E ₉	F ₁₀	G ₁₁	H ₁₂	I ₁₃
3849	4019	4209	4399	4679	4969	5219	5699	6619	7229	7759

KOU30I - 3 Seat Lounge Chair with Intervening Arms

Dimensions

Overall			Seat		
W	D	H	W	D	H
76.25	30	33.75	21.75	19	18
			Back H	Arm H	
			15.75	25	

COM: 9 yd
 Wt Cap: 1000 lb
 Unit Weight: 196 lb

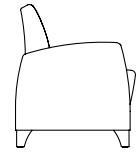
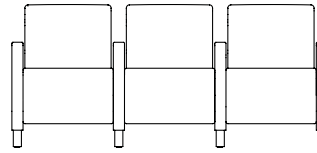

KOU30I Standard with Fully Upholstered Arms (Refer to pg 54 for arm cap options)

COM	Dillon/Carson	A ₅	B ₆	C ₇	D ₈	E ₉	F ₁₀	G ₁₁	H ₁₂	I ₁₃
5079	5269	5519	5769	6119	6489	6829	7419	8179	8819	9479

KOU30IBC - 3 Seat Center 29.5" Bariatric Lounge Chair with Intervening Arms

Dimensions

Overall			Seat		
W	D	H	W	D	H
84	30	33.75	29.5	19	18
			Back H	Arm H	
			15.75	25	

COM: 9.5 yd
 Wt Cap: 1000 lb
 Unit Weight: 205 lb

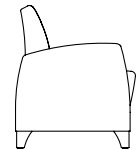
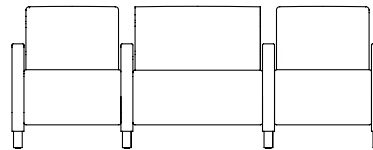

KOU30IBC Standard with Fully Upholstered Arms (Refer to pg 54 for arm cap options)

COM	Dillon/Carson	A ₅	B ₆	C ₇	D ₈	E ₉	F ₁₀	G ₁₁	H ₁₂	I ₁₃
5639	6119	6169	6259	6519	6929	7139	7739	8509	9199	9869

KOU30IBL - 3 Seat Left 29.5" Bariatric Lounge Chair with Intervening Arms

Dimensions

Overall			Seat		
W	D	H	W	D	H
84	30	33.75	29.5	19	18
			Back H	Arm H	
			15.75	25	

COM: 9.5 yd
 Wt Cap: 1000 lb
 Unit Weight: 205 lb

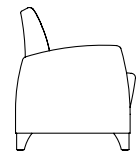
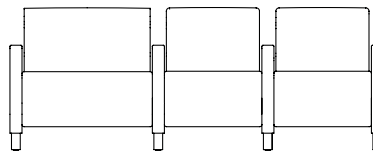

KOU30IBL Standard with Fully Upholstered Arms (Refer to pg 54 for arm cap options)

COM	Dillon/Carson	A ₅	B ₆	C ₇	D ₈	E ₉	F ₁₀	G ₁₁	H ₁₂	I ₁₃
5639	5789	6039	6259	6519	6879	7139	7739	8509	9199	9869

KOU30IBR - 3 Seat Right 29.5" Bariatric Lounge Chair with Intervening Arms

Dimensions

Overall			Seat		
W	D	H	W	D	H
84	30	33.75	29.5	19	18
			Back H	Arm H	
			15.75	25	

COM: 9.5 yd
 Wt Cap: 1000 lb
 Unit Weight: 205 lb

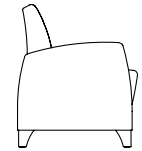
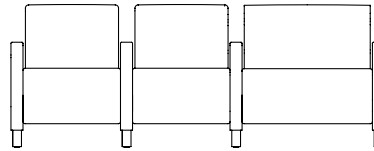

KOU30IBR Standard with Fully Upholstered Arms (Refer to pg 54 for arm cap options)

COM	Dillon/Carson	A ₅	B ₆	C ₇	D ₈	E ₉	F ₁₀	G ₁₁	H ₁₂	I ₁₃
5639	5789	6039	6259	6519	6879	7139	7739	8509	9199	9869

KOU15T - Upholstered Lounge 15" Inline Table

Dimensions

Overall		
W	D	H
16	20.25	19

COM: 1.5 yd
 Unit Weight: 34 lb

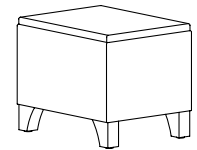

KOU15T Standard with Thermofoil Top (Contact customer service for solid surface pricing - KOU15J)

COM	Dillon/Carson	A ₅	B ₆	C ₇	D ₈	E ₉	F ₁₀	G ₁₁	H ₁₂	I ₁₃
1169	1179	1189	1209	1219	1239	1259	1279	1429	1499	1529

KOU90T - Upholstered Lounge 90 Degree Corner Table

Dimensions

Overall		
W	D	H
45	23.75	18.25

COM: 1.5 yd
 Unit Weight: 60 lb

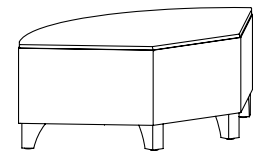

KOU90T Standard with Thermofoil Top (Contact customer service for solid surface pricing - KOU90J)

COM	Dillon/Carson	A ₅	B ₆	C ₇	D ₈	E ₉	F ₁₀	G ₁₁	H ₁₂	I ₁₃
1569	1589	1599	1609	1649	1669	1679	1729	1899	1979	2049



General Product Information

- Standard with fully upholstered arms & wood feet
- Seat and back frames are poplar plywood construction; joints are CNC cut/puzzle-jointed, glued, stapled together, and reinforced with corner blocks for superior strength
- European beech wood feet feature a fixed glide
- All feet options utilize common height & mounting hole for field adaptability
- 7.5 gauge steel sinuous seat springs
- Seat foam: 2.5 density foam that meets CAL 117 Fire Standards
- Back foam: 1.7 high resilience density foam that meets CAL 117 Fire Standards
- Arms are bolted to seat/back center sections & can be easily replaced in field if necessary

To Order, Specify

- Model Number
- Textile
- Finish
- Options

Available Options

ARM CAP OPTIONS		<i>See pg 2 for finishes</i>
U	Urethane	169
J1	Solid Surface - Group 1	689
J2	Solid Surface - Group 2	889
F	Fully Upholstered Arms	Standard

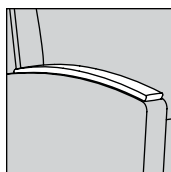

Arm Cap Profile

FEET OPTIONS		<i>See pg 2 for finishes</i>
WF	Wood Feet	Standard
MF	Metal Feet with Adjustable Glides	359
<i>*Standard in 211 Silver Frost finish</i>		

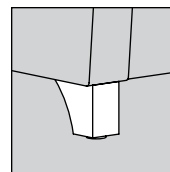

Wood Feet

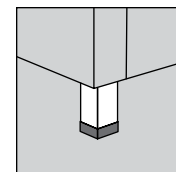

Metal Feet

ADDITIONAL FEATURES & OPTIONS

CAL	CAL TB133	See pg 9
Z	Multi Cover	Use Pricing for Highest Grade
MB	Moisture Barrier	See pg 11

DL10 - Lounge Chair

Dimensions

Overall			Seat		
W	D	H	W	D	H
28.25	30	33	22.5	19	18.5
			Back H	Arm H	
			15	25.5	

COM: 4.5 yd
Wt Cap: 350 lb
Unit Weight: 76 lb

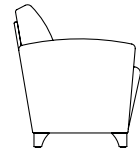
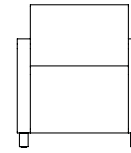

DL10 Standard with Fully Upholstered Arms (Refer to pg 60 for arm cap options)

COM	Dillon/Carson	A ₅	B ₆	C ₇	D ₈	E ₉	F ₁₀	G ₁₁	H ₁₂	I ₁₃
1939	2059	2139	2269	2389	2569	2699	2959	3779	4079	4339

DL20 - Lounge Loveseat

Dimensions

Overall			Seat		
W	D	H	W	D	H
50.75	30	33	45	19	18.5
			Back H	Arm H	
			15	25.5	

COM: 6.5 yd
Wt Cap: 500 lb
Unit Weight: 113 lb

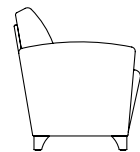
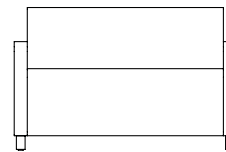

DL20 Standard with Fully Upholstered Arms (Refer to pg 60 for arm cap options)

COM	Dillon/Carson	A ₅	B ₆	C ₇	D ₈	E ₉	F ₁₀	G ₁₁	H ₁₂	I ₁₃
2719	2859	3009	3159	3379	3619	3799	4159	5039	5269	5659

DL30 - Lounge Sofa

Dimensions

Overall			Seat		
W	D	H	W	D	H
72.75	30	33	67	19	18.5
			Back H	Arm H	
			15	25.5	

COM: 7.5 yd
Wt Cap: 750 lb
Unit Weight: 144 lb

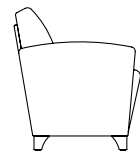
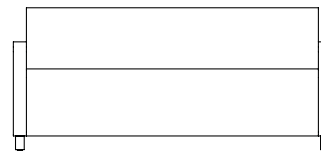

DL30 Standard with Fully Upholstered Arms (Refer to pg 60 for arm cap options)

COM	Dillon/Carson	A ₅	B ₆	C ₇	D ₈	E ₉	F ₁₀	G ₁₁	H ₁₂	I ₁₃
3409	3599	3799	4029	4309	4649	4889	5379	6289	6699	6999



General Product Information

- Seat and back frames are poplar plywood construction; joints are CNC cut/puzzle-jointed, glued, stapled together, and reinforced with corner blocks for superior strength
- Seat foam: 2.5 density foam that meets CAL 117 Fire Standards
- Back foam: 1.7 high resilience density foam that meets CAL 117 Fire Standards
- 10 gauge heavy duty steel springs in back
- 7.5 gauge steel sinuous seat springs for lasting comfort
- Standard with round metal legs with adjustable glides
- Ganging brackets included with armless units

To Order, Specify

- Model Number
- Textile
- Finish
- Options

Available Options

ARM CAP OPTIONS		<i>See pg 2 for finishes</i>
U	Urethane	Standard on specified models
J	Solid Surface	Standard on specified models
F	Fully Upholstered Arms	Standard on specified models

POWER OPTIONS	
PUB	Power ¹ (USB-A/USB-C/Grounded Receptacle) 209

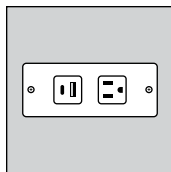

- Power Placement:**
- Armless Models- front center of seat*
 - Seat with Arms- side of left (facing) arm*
 - Left Arm Models- side of left (facing) arm*
 - Right Arm Models- side of right (facing) arm*
 - Table Models- front center of table*

LEG OPTIONS		<i>See pg 2 for finishes</i>
RL	Round Metal Legs	Standard
	<i>*Standard in 211 Silver Frost finish</i>	
SL	Square Metal Legs	No Upcharge
	<i>*Standard in 211 Silver Frost finish</i>	

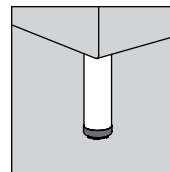

Round Metal Leg

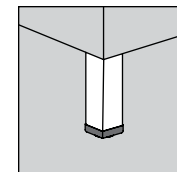

Square Metal Leg

ADDITIONAL FEATURES & OPTIONS

CAL	CAL TB133	See pg 9
Z	Multi Cover	Use Pricing for Highest Grade
MB	Moisture Barrier	See pg 11

AS10N - Armless Lounge Chair

Dimensions

Overall			Seat		
W	D	H	W	D	H
24.5	30.75	32.75	24.5	21.5	18.5
			Back H	Arm H	
			14.25	n/a	

COM: 3 yds
Wt Cap: 500 lb
Unit Weight: 48 lb

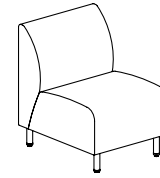

Pricing

COM	Dillon/Carson	A ₅	B ₆	C ₇	D ₈	E ₉	F ₁₀	G ₁₁	H ₁₂	I ₁₃
1609	1629	1669	1709	1779	1879	1949	2089	2529	2649	2799

AS10NC - Armless Lounge Chair on Casters

Dimensions

Overall			Seat		
W	D	H	W	D	H
24.5	30.75	32.75	24.5	21.5	18.5
			Back H	Arm H	
			14.25	n/a	

COM: 3 yds
Wt Cap: 500 lb
Unit Weight: 48 lb

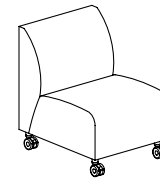

Pricing

COM	Dillon/Carson	A ₅	B ₆	C ₇	D ₈	E ₉	F ₁₀	G ₁₁	H ₁₂	I ₁₃
1839	1869	1919	1959	2039	2119	2179	2329	2759	2899	3079

AS20N - 2 Seat Armless Lounge Chair

Dimensions

Overall			Seat		
W	D	H	W	D	H
48.75	30.75	32.75	48.75	21.5	18.5
			Back H	Arm H	
			14.25	n/a	

COM: 4.5 yds
Wt Cap: 750 lb
Unit Weight: 94 lb

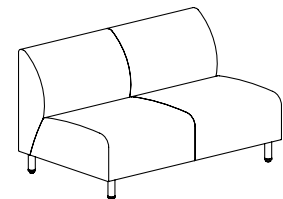

Pricing

COM	Dillon/Carson	A ₅	B ₆	C ₇	D ₈	E ₉	F ₁₀	G ₁₁	H ₁₂	I ₁₃
2599	2659	2779	2869	3019	3169	3309	3559	4189	4469	4739

AS30N - 3 Seat Armless Lounge Chair

Dimensions

Overall			Seat		
W	D	H	W	D	H
72.75	30.75	32.75	72.75	21.5	18.5
			Back H	Arm H	
			14.25	n/a	

COM: 8.5 yds
Wt Cap: 1000 lb
Unit Weight: 138 lb

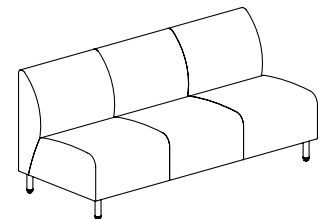

Pricing

COM	Dillon/Carson	A ₅	B ₆	C ₇	D ₈	E ₉	F ₁₀	G ₁₁	H ₁₂	I ₁₃
3599	3749	3869	4059	4269	4519	4719	5109	6289	6579	6969

AS12A - Lounge Chair with Square Arms

Dimensions

Overall			Seat				
W	D	H	W	D	H		
29.5	30.75	32.75	24	21.5	18.5		
			Back H	Arm H			
			14.25	26			

COM: 5 yds
 Wt Cap: 500 lb
 Unit Weight: 78 lb

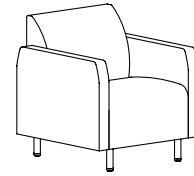

AS12AF with Fully Upholstered Arms

COM	Dillon	Carson	A ₅	B ₆	C ₇	D ₈	E ₉	F ₁₀	G ₁₁	H ₁₂	I ₁₃
2129	2219	2379	2519	2699	2889	3089	3409	3779	3949	4219	

AS12AU with Urethane Arm Caps

COM	Dillon	Carson	A ₅	B ₆	C ₇	D ₈	E ₉	F ₁₀	G ₁₁	H ₁₂	I ₁₃
2319	2439	2559	2689	2879	3099	3269	3579	3979	4339	4729	

AS12AJ with Solid Surface Arm Caps (Add \$100 List per arm cap for Group 2 solid surface finish)

COM	Dillon	Carson	A ₅	B ₆	C ₇	D ₈	E ₉	F ₁₀	G ₁₁	H ₁₂	I ₁₃
2739	2839	2999	3129	3319	3509	3699	4029	4389	4599	4999	

AS12L - Lounge Chair with Left Square Arm

Dimensions

Overall			Seat				
W	D	H	W	D	H		
27	30.75	32.75	24	21.5	18.5		
			Back H	Arm H			
			14.25	26			

COM: 3.5 yds
 Wt Cap: 500 lb
 Unit Weight: 64 lb

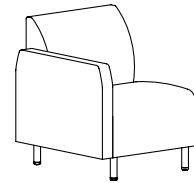

AS12LF with Fully Upholstered Arms

COM	Dillon	Carson	A ₅	B ₆	C ₇	D ₈	E ₉	F ₁₀	G ₁₁	H ₁₂	I ₁₃
1819	1899	1989	2089	2199	2369	2469	2709	3209	3499	3729	

AS12LU with Urethane Arm Caps

COM	Dillon	Carson	A ₅	B ₆	C ₇	D ₈	E ₉	F ₁₀	G ₁₁	H ₁₂	I ₁₃
1929	1999	2089	2169	2329	2449	2589	2809	3309	3579	3869	

AS12LJ with Solid Surface Arm Caps (Add \$100 List per arm cap for Group 2 solid surface finish)

COM	Dillon	Carson	A ₅	B ₆	C ₇	D ₈	E ₉	F ₁₀	G ₁₁	H ₁₂	I ₁₃
2129	2199	2309	2399	2519	2679	2789	3029	3529	3819	4079	

AS12R - Lounge Chair with Right Square Arm

Dimensions

Overall			Seat				
W	D	H	W	D	H		
27	30.75	32.75	24	21.5	18.5		
			Back H	Arm H			
			14.25	26			

COM: 3.5 yds
 Wt Cap: 500 lb
 Unit Weight: 64 lb

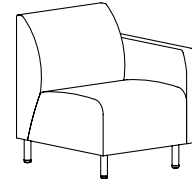

AS12RF with Fully Upholstered Arms

COM	Dillon	Carson	A ₅	B ₆	C ₇	D ₈	E ₉	F ₁₀	G ₁₁	H ₁₂	I ₁₃
1819	1899	1989	2089	2199	2369	2469	2709	3209	3499	3729	

AS12RU with Urethane Arm Caps

COM	Dillon	Carson	A ₅	B ₆	C ₇	D ₈	E ₉	F ₁₀	G ₁₁	H ₁₂	I ₁₃
1929	1999	2089	2169	2329	2449	2589	2809	3309	3579	3869	

AS12RJ with Solid Surface Arm Caps (Add \$100 List per arm cap for Group 2 solid surface finish)

COM	Dillon	Carson	A ₅	B ₆	C ₇	D ₈	E ₉	F ₁₀	G ₁₁	H ₁₂	I ₁₃
2129	2199	2309	2399	2519	2679	2789	3029	3529	3819	4079	

AS22A - 2 Seat Lounge Chair with Square Arms

Dimensions

Overall			Seat				
W	D	H	W	D	H		
53.5	30.75	32.75	48.5	21.5	18.5		
			Back H	Arm H			
			14.25	26			

COM: 7 yds
 Wt Cap: 750 lb
 Unit Weight: 123 lb

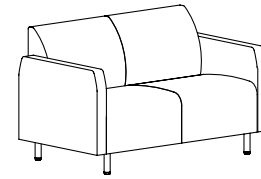

AS22AF with Fully Upholstered Arms

COM	Dillon	Carson	A ₅	B ₆	C ₇	D ₈	E ₉	F ₁₀	G ₁₁	H ₁₂	I ₁₃
3119	3279	3399	3579	3789	4049	4249	4629	5509	5799	6179	

AS22AU with Urethane Arm Caps

COM	Dillon	Carson	A ₅	B ₆	C ₇	D ₈	E ₉	F ₁₀	G ₁₁	H ₁₂	I ₁₃
3329	3449	3589	3769	3999	4229	4419	4799	5679	5999	6449	

AS22AJ with Solid Surface Arm Caps (Add \$100 List per arm cap for Group 2 solid surface finish)

COM	Dillon	Carson	A ₅	B ₆	C ₇	D ₈	E ₉	F ₁₀	G ₁₁	H ₁₂	I ₁₃
3739	3879	4019	4199	4399	4659	4859	5249	6129	6319	6579	

AS22L - 2 Seat Lounge Chair with Left Square Arm

Dimensions

Overall			Seat				
W	D	H	W	D	H		
51	30.75	32.75	48.5	21.5	18.5		
			Back H	Arm H			
			14.25	26			

COM: 6 yds
 Wt Cap: 750 lb
 Unit Weight: 111 lb

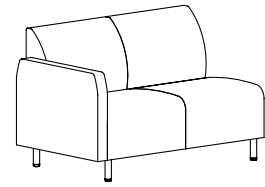

AS22LF with Fully Upholstered Arms

COM	Dillon	Carson	A ₅	B ₆	C ₇	D ₈	E ₉	F ₁₀	G ₁₁	H ₁₂	I ₁₃
2859	2949	3059	3219	3379	3589	3759	4059	4729	5049	5399	

AS22LU with Urethane Arm Caps

COM	Dillon	Carson	A ₅	B ₆	C ₇	D ₈	E ₉	F ₁₀	G ₁₁	H ₁₂	I ₁₃
2959	3059	3149	3319	3489	3689	3849	4159	4809	5389	5799	

AS22LJ with Solid Surface Arm Caps (Add \$100 List per arm cap for Group 2 solid surface finish)

COM	Dillon	Carson	A ₅	B ₆	C ₇	D ₈	E ₉	F ₁₀	G ₁₁	H ₁₂	I ₁₃
3169	3269	3369	3539	3689	3899	4069	4369	5039	5689	6319	

AS22R - 2 Seat Lounge Chair with Right Square Arm

Dimensions

Overall			Seat				
W	D	H	W	D	H		
51	30.75	32.75	48.5	21.5	18.5		
			Back H	Arm H			
			14.25	26			

COM: 6 yds
 Wt Cap: 750 lb
 Unit Weight: 111 lb

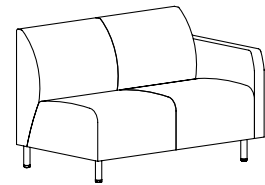

AS22RF with Fully Upholstered Arms

COM	Dillon	Carson	A ₅	B ₆	C ₇	D ₈	E ₉	F ₁₀	G ₁₁	H ₁₂	I ₁₃
2859	2949	3059	3219	3379	3589	3759	4059	4729	5049	5399	

AS22RU with Urethane Arm Caps

COM	Dillon	Carson	A ₅	B ₆	C ₇	D ₈	E ₉	F ₁₀	G ₁₁	H ₁₂	I ₁₃
2959	3059	3149	3319	3489	3689	3849	4159	4809	5389	5799	

AS22RJ with Solid Surface Arm Caps (Add \$100 List per arm cap for Group 2 solid surface finish)

COM	Dillon	Carson	A ₅	B ₆	C ₇	D ₈	E ₉	F ₁₀	G ₁₁	H ₁₂	I ₁₃
3169	3269	3369	3539	3689	3899	4069	4369	5039	5689	6319	

AS32A - 3 Seat Lounge Chair with Square Arms

Dimensions

Overall			Seat				
W	D	H	W	D	H	Back H	Arm H
77.5	30.75	32.75	72.5	21.5	18.5	14.25	26

COM: 10.5 yds
 Wt Cap: 1000 lb
 Unit Weight: 167 lb

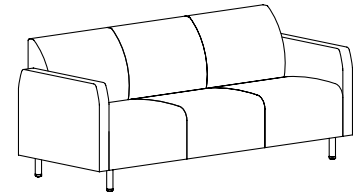

AS32AF with Fully Upholstered Arms

COM	Dillon	Carson	A5	B6	C7	D8	E9	F10	G11	H12	I13
4099	4269	4499	4749	5049	5429	5709	6249	7229	7499	8159	

AS32AU with Urethane Arm Caps

COM	Dillon	Carson	A5	B6	C7	D8	E9	F10	G11	H12	I13
4299	4479	4689	4939	5239	5599	5889	6439	7409	7599	8159	

AS32AJ with Solid Surface Arm Caps (Add \$100 List per arm cap for Group 2 solid surface finish)

COM	Dillon	Carson	A5	B6	C7	D8	E9	F10	G11	H12	I13
4719	4879	5109	5359	5659	6039	6309	6869	7849	8139	8549	

AS32L - 3 Seat Lounge Chair with Left Square Arm

Dimensions

Overall			Seat				
W	D	H	W	D	H	Back H	Arm H
75	30.75	32.75	72.5	21.5	18.5	14.25	26

COM: 9.5 yds
 Wt Cap: 1000 lb
 Unit Weight: 153 lb

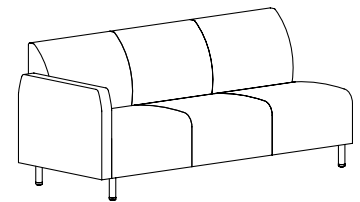

AS32LF with Fully Upholstered Arms

COM	Dillon	Carson	A5	B6	C7	D8	E9	F10	G11	H12	I13
3779	3889	4079	4259	4509	4799	5029	5479	6619	6849	7239	

AS32LU with Urethane Arm Caps

COM	Dillon	Carson	A5	B6	C7	D8	E9	F10	G11	H12	I13
3859	4019	4189	4359	4599	4909	5119	5559	6709	6979	7369	

AS32LJ with Solid Surface Arm Caps (Add \$100 List per arm cap for Group 2 solid surface finish)

COM	Dillon	Carson	A5	B6	C7	D8	E9	F10	G11	H12	I13
4089	4209	4389	4569	4819	5109	5339	5789	6929	7179	7449	

AS32R - 3 Seat Lounge Chair with Right Square Arm

Dimensions

Overall			Seat				
W	D	H	W	D	H		
75	30.75	32.75	72.5	21.5	18.5		
			Back H	Arm H			
			14.25	26			

COM: 9.5 yds
 Wt Cap: 1000 lb
 Unit Weight: 153 lb

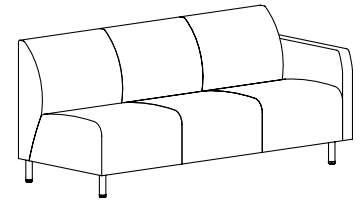

AS32RF with Fully Upholstered Arms

COM	Dillon	Carson	A ₅	B ₆	C ₇	D ₈	E ₉	F ₁₀	G ₁₁	H ₁₂	I ₁₃
3779	3889	4079	4259	4509	4799	5029	5479	6619	6849	7239	

AS32RU with Urethane Arm Caps

COM	Dillon	Carson	A ₅	B ₆	C ₇	D ₈	E ₉	F ₁₀	G ₁₁	H ₁₂	I ₁₃
3859	4019	4189	4359	4599	4909	5119	5559	6709	6979	7369	

AS32RJ with Solid Surface Arm Caps (Add \$100 List per arm cap for Group 2 solid surface finish)

COM	Dillon	Carson	A ₅	B ₆	C ₇	D ₈	E ₉	F ₁₀	G ₁₁	H ₁₂	I ₁₃
4089	4209	4389	4569	4819	5109	5339	5789	6929	7149	7449	

AS90IC - 90 Degree Inside Corner Lounge Chair

Dimensions

Overall			Seat		
W	D	H	W	D	H
51.25	34.5	32.75	50	25.5	18.5
			Back H	Arm H	
			14.25	n/a	

COM: 4 yds
 Wt Cap: 750 lb
 Unit Weight: 75 lb

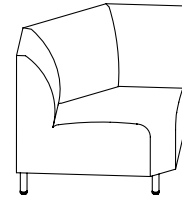

Pricing

COM	Dillon/Carson	A ₅	B ₆	C ₇	D ₈	E ₉	F ₁₀	G ₁₁	H ₁₂	I ₁₃
2239	2359	2419	2519	2609	2789	2879	3139	3779	4079	4349

AS90OC - 90 Degree Outside Corner Lounge Chair

Dimensions

Overall			Seat		
W	D	H	W	D	H
50.5	34.5	32.75	50.5	22.5	18.5
			Back H	Arm H	
			14.25	n/a	

COM: 3 yds
 Wt Cap: 750 lb
 Unit Weight: 69 lb

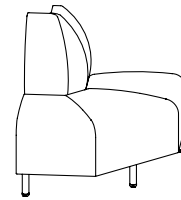

Pricing

COM	Dillon/Carson	A ₅	B ₆	C ₇	D ₈	E ₉	F ₁₀	G ₁₁	H ₁₂	I ₁₃
2179	2299	2369	2439	2549	2719	2829	3089	3729	3949	4159

ASB2424 - 24" One Seat Bench

Dimensions

Overall			Seat		
W	D	H	W	D	H
24.5	24.5	18.5	24.5	24.5	18.5

COM: 2 yds
 Wt Cap: 400 lb
 Unit Weight: 32 lb

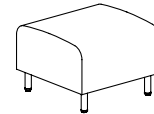

Pricing

COM	Dillon/Carson	A ₅	B ₆	C ₇	D ₈	E ₉	F ₁₀	G ₁₁	H ₁₂	I ₁₃
1239	1249	1269	1279	1309	1409	1439	1489	1839	2049	2159

ASB2448 - 24" Two Seat Bench

Dimensions

Overall			Seat		
W	D	H	W	D	H
48.5	24.5	18.5	48.5	24.5	18.5

COM: 2.5 yds
 Wt Cap: 650 lb
 Unit Weight: 62 lb

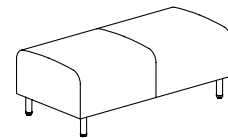

Pricing

COM	Dillon/Carson	A ₅	B ₆	C ₇	D ₈	E ₉	F ₁₀	G ₁₁	H ₁₂	I ₁₃
2039	2069	2109	2149	2179	2289	2309	2399	2679	2769	2899

ASB2472 - 24" Three Seat Bench

Dimensions

Overall			Seat		
W	D	H	W	D	H
72.5	24.5	18.5	72.5	24.5	18.5

COM: 3.5 yds
 Wt Cap: 900 lb
 Unit Weight: 85 lb

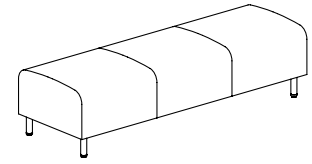

Pricing

COM	Dillon/Carson	A ₅	B ₆	C ₇	D ₈	E ₉	F ₁₀	G ₁₁	H ₁₂	I ₁₃
2419	2449	2499	2539	2569	2639	2759	2999	3399	3599	3819

ASB3024 - 30" One Seat Bench

Dimensions

Overall			Seat		
W	D	H	W	D	H
24.5	30.35	18.5	24.5	30.5	18.5

COM: 3 yds
 Wt Cap: 400 lb
 Unit Weight: 67 lb

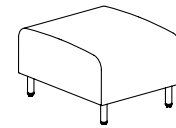

Pricing

COM	Dillon/Carson	A ₅	B ₆	C ₇	D ₈	E ₉	F ₁₀	G ₁₁	H ₁₂	I ₁₃
1329	1339	1349	1369	1429	1509	1569	1669	2139	2369	2579

ASB3048 - 30" Two Seat Bench

Dimensions

Overall			Seat		
W	D	H	W	D	H
48.5	30.5	18.5	48.5	30.5	18.5

COM: 3 yds
 Wt Cap: 650 lb
 Unit Weight: 67 lb

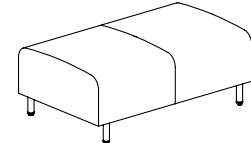

Pricing

COM	Dillon/Carson	A ₅	B ₆	C ₇	D ₈	E ₉	F ₁₀	G ₁₁	H ₁₂	I ₁₃
2149	2179	2219	2299	2339	2389	2409	2529	2829	3029	3209

ASB3072 - 30" Three Seat Bench

Dimensions

Overall			Seat		
W	D	H	W	D	H
72.5	30.5	18.5	72.5	30.5	18.5

COM: 4.5 yds
 Wt Cap: 900 lb
 Unit Weight: 92 lb

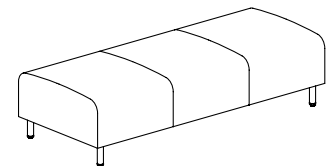

Pricing

COM	Dillon/Carson	A ₅	B ₆	C ₇	D ₈	E ₉	F ₁₀	G ₁₁	H ₁₂	I ₁₃
2669	2689	2759	2799	2829	2869	2999	3219	3889	4199	4529

AST10 - Table with Thermofoil Top (Contact customer service for solid surface pricing)

Dimensions

Overall		
W	D	H
24.5	29.75	15.5

COM: 1.5 yds
Unit Weight: 51 lb

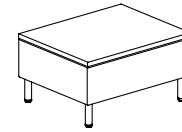

Pricing

COM	Dillon/Carson	A ₅	B ₆	C ₇	D ₈	E ₉	F ₁₀	G ₁₁	H ₁₂	I ₁₃
1369	1409	1459	1479	1489	1509	1519	1619	1899	1979	2049

AST15 - Inline Table with Thermofoil Top (Contact customer service for solid surface pricing)

Dimensions

Overall		
W	D	H
16	20.25	15.5

COM: 1.5 yds
Unit Weight: 34 lb

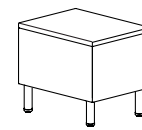

Pricing

COM	Dillon/Carson	A ₅	B ₆	C ₇	D ₈	E ₉	F ₁₀	G ₁₁	H ₁₂	I ₁₃
1129	1139	1149	1169	1179	1219	1229	1259	1589	1629	1699

AST90 - 90 Degree Table with Thermofoil Top (Contact customer service for solid surface pricing)

Dimensions

Overall		
W	D	H
50.75	34.75	15.5

COM: 1.5 yds
Unit Weight: 78 lb

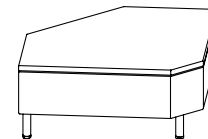

Pricing

COM	Dillon/Carson	A ₅	B ₆	C ₇	D ₈	E ₉	F ₁₀	G ₁₁	H ₁₂	I ₁₃
1919	1969	1999	2049	2079	2109	2159	2249	2359	2419	2499



General Product Information

- Seat clean-out
- All interior joints are CNC cut/puzzle-jointed, corner blocked, screwed, & glued together
- Commercial grade double-walled plywood interior
- Kiln-dried hardwood interior components
- Arms connected by 14 gauge steel support tubes
- Seat foam: 2.8 high resilience density foam that meets CAL 117 Fire Standards
- Back foam: 2.5 density foam that meets CAL 117 Fire Standards
- Steel sinuous springs in seat & back
- Field replaceable components

To Order, Specify

- Model Number
- Textile
- Finish
- Options

Available Options

ARM CAP OPTIONS		<i>See pg 2 for finishes</i>
T	Thermofoil	Standard on specified models
J	Solid Surface	Contact customer service
F	Fully Upholstered Arms	Standard on specified models

POWER OPTIONS		
PUB8	Power (USB-A/USB-C/Grounded Receptacle)	209

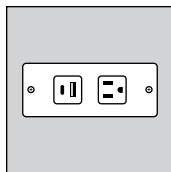

Power Placement:
 3.5" Arm Models - outside of left (facing) arm
 8.5" Arm Models - front of left (facing) arm

ADDITIONAL FEATURES & OPTIONS		
CAL	CAL TB133	See pg 9
Z	Multi Cover	Use Pricing for Highest Grade
MB	Moisture Barrier	See pg 11

LEG OPTIONS		<i>See pg 2 for finishes</i>
--------------------	--	------------------------------

ML	Metal Legs with Adjustable Glides	Standard
	<i>*Standard in 540 Pewter finish</i>	
WL	Wood Legs with Adjustable Glides	No Upcharge
WTL	Wood Tapered Legs with Adjustable Glides	279

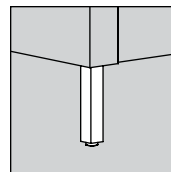

Metal Leg

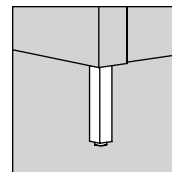

Wood Leg

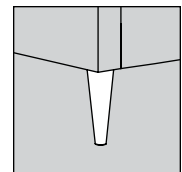

Wood Tapered Leg

KAS10 - Lounge Chair with 22" Wide Seat, 3.5" Arms

Dimensions

Overall			Seat		
W	D	H	W	D	H
29.5	27.75	31.75	22.25	19.125	18.375
			Back H	Arm H	
			14.5	25.25	

COM: 4 yds
 Wt Cap: 550 lb
 Unit Weight: 74 lb

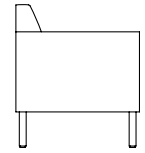
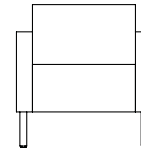

KAS10F with Fully Upholstered Arms

COM	Dillon	Carson	A ₅	B ₆	C ₇	D ₈	E ₉	F ₁₀	G ₁₁	H ₁₂	I ₁₃
1929	2039	2129	2189	2359	2489	2639	2889	3429	3739	3999	

KAS10A with Thermofoil Arm Caps

COM	Dillon	Carson	A ₅	B ₆	C ₇	D ₈	E ₉	F ₁₀	G ₁₁	H ₁₂	I ₁₃
2029	2119	2199	2309	2469	2619	2739	2979	3519	3819	4079	

*Contact customer service for solid surface pricing of arm caps or back rail caps (on applicable models).

KAS13 - Lounge Chair with 22" Wide Seat, 3.5" Arms & Boxed Back

Dimensions

Overall			Seat		
W	D	H	W	D	H
29.5	31.25	31.75	22.25	19.125	18.375
			Back H	Arm H	
			14.5	25.25	

COM: 4 yds
 Wt Cap: 550 lb
 Unit Weight: 93 lb

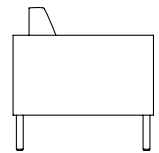
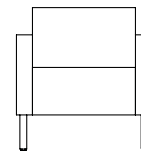

KAS13F with Fully Upholstered Arms

COM	Dillon	Carson	A ₅	B ₆	C ₇	D ₈	E ₉	F ₁₀	G ₁₁	H ₁₂	I ₁₃
2039	2129	2229	2349	2479	2669	2789	3059	3669	3949	4199	

KAS13A with Thermofoil Arm Caps and Back Rail Cap

COM	Dillon	Carson	A ₅	B ₆	C ₇	D ₈	E ₉	F ₁₀	G ₁₁	H ₁₂	I ₁₃
2139	2229	2339	2449	2589	2759	2889	3149	3729	4029	4349	

*Contact customer service for solid surface pricing of arm caps or back rail caps (on applicable models).

KAS10B - Lounge Chair with 30" Wide Seat, 3.5" Arms

Dimensions

Overall			Seat			COM: 5 yds	
W	D	H	W	D	H	Wt Cap:	Unit Weight:
37.25	27.75	31.75	30	19.125	18.375	750 lb	83 lb
			Back H	Arm H			
			14.5	25.25			

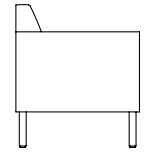
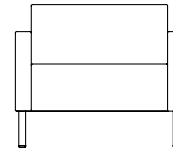

KAS10BF with Fully Upholstered Arms

COM	Dillon	Carson	A ₅	B ₆	C ₇	D ₈	E ₉	F ₁₀	G ₁₁	H ₁₂	I ₁₃
2109	2189	2279	2399	2519	2729	2849	3119	3899	4199	4599	

KAS10BA with Thermofoil Arm Caps

COM	Dillon	Carson	A ₅	B ₆	C ₇	D ₈	E ₉	F ₁₀	G ₁₁	H ₁₂	I ₁₃
2169	2249	2369	2469	2609	2789	2909	3169	3979	4299	4609	

*Contact customer service for solid surface pricing of arm caps or back rail caps (on applicable models).

KAS13B - Lounge Chair with 30" Wide Seat, 3.5" Arms & Boxed Back

Dimensions

Overall			Seat			COM: 5 yds	
W	D	H	W	D	H	Wt Cap:	Unit Weight:
37.25	31.25	31.75	30	19.125	18.375	750 lb	103 lb
			Back H	Arm H			
			14.5	25.25			

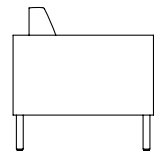
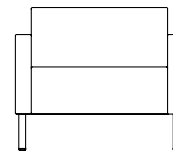

KAS13BF with Fully Upholstered Arms

COM	Dillon	Carson	A ₅	B ₆	C ₇	D ₈	E ₉	F ₁₀	G ₁₁	H ₁₂	I ₁₃
2219	2279	2409	2499	2649	2829	2939	3209	4199	4479	4869	

KAS13BA with Thermofoil Arm Caps and Back Rail Cap

COM	Dillon	Carson	A ₅	B ₆	C ₇	D ₈	E ₉	F ₁₀	G ₁₁	H ₁₂	I ₁₃
2309	2429	2509	2619	2759	2929	3059	3319	4299	4739	5129	

*Contact customer service for solid surface pricing of arm caps or back rail caps (on applicable models).

KAS18 - Lounge Chair with 30" Wide Seat, 8.5" Arms & Boxed Back

Dimensions

Overall			Seat			<div style="background-color: #555; color: white; padding: 5px; text-align: center;"> COM: 5 yds Wt Cap: 750 lb Unit Weight: 92 lb </div>	
W	D	H	W	D	H		
48	31.25	31.75	30	19.125	18.375		
			Back H	Arm H			
			14.5	25.25			

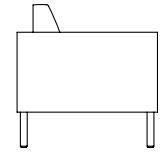
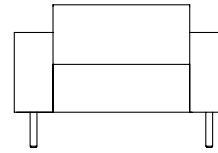

KAS18F with Fully Upholstered Arms

COM	Dillon/Carson	A ₅	B ₆	C ₇	D ₈	E ₉	F ₁₀	G ₁₁	H ₁₂	I ₁₃
2259	2369	2469	2569	2699	2889	2989	3249	4369	4739	5129

KAS18A with Thermofoil Arm Caps and Back Rail Cap

COM	Dillon/Carson	A ₅	B ₆	C ₇	D ₈	E ₉	F ₁₀	G ₁₁	H ₁₂	I ₁₃
2409	2519	2609	2709	2869	3009	3149	3399	4529	4869	5269

*Contact customer service for solid surface pricing of arm caps or back rail caps (on applicable models).

KAS20 - 2 Seat Lounge Chair with 3.5" Arms

Dimensions

Overall			Seat			<div style="background-color: #555; color: white; padding: 5px; text-align: center;"> COM: 5.5 yds Wt Cap: 750 lb Unit Weight: 102 lb </div>	
W	D	H	W	D	H		
51	27.75	31.75	44.5	19.125	18.375		
			Back H	Arm H			
			14.5	25.25			

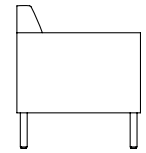
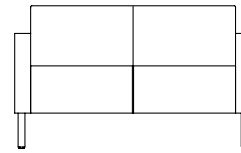

KAS20F with Fully Upholstered Arms

COM	Dillon/Carson	A ₅	B ₆	C ₇	D ₈	E ₉	F ₁₀	G ₁₁	H ₁₂	I ₁₃
2739	2889	3009	3169	3389	3629	3819	4179	4669	4999	5399

KAS20A with Thermofoil Arm Caps

COM	Dillon/Carson	A ₅	B ₆	C ₇	D ₈	E ₉	F ₁₀	G ₁₁	H ₁₂	I ₁₃
2819	2949	3099	3239	3449	3699	3879	4249	4779	5259	5659

*Contact customer service for solid surface pricing of arm caps or back rail caps (on applicable models).

KAS23 - 2 Seat Lounge Chair with 3.5" Arms & Boxed Back

Dimensions

Overall			Seat			COM: 5.5 yds Wt Cap: 750 lb Unit Weight: 128 lb
W	D	H	W	D	H	
52	31.25	31.75	44.5	19.125	18.375	
		Back H			Arm H	
		14.5			25.25	

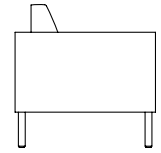
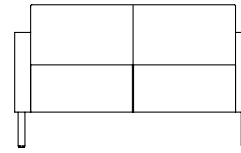

KAS23F with Fully Upholstered Arms

COM	Dillon	Carson	A ₅	B ₆	C ₇	D ₈	E ₉	F ₁₀	G ₁₁	H ₁₂	I ₁₃
3169	3289	3399	3559	3739	3919	4109	4439	5109	5529	5919	

KAS23A with Thermofoil Arm Caps and Back Rail Cap

COM	Dillon	Carson	A ₅	B ₆	C ₇	D ₈	E ₉	F ₁₀	G ₁₁	H ₁₂	I ₁₃
3309	3419	3529	3649	3909	4089	4219	4599	5289	5739	6179	

*Contact customer service for solid surface pricing of arm caps or back rail caps (on applicable models).

KAS28 - 2 Seat Lounge Chair with 8.5" Arms & Boxed Back

Dimensions

Overall			Seat			COM: 6.5 yds Wt Cap: 750 lb Unit Weight: 136 lb
W	D	H	W	D	H	
64	31.25	31.75	44.5	19.125	18.375	
		Back H			Arm H	
		14.5			25.25	

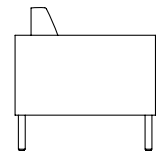
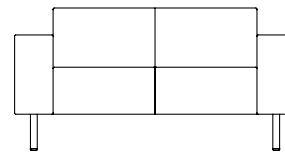

KAS28F with Fully Upholstered Arms

COM	Dillon	Carson	A ₅	B ₆	C ₇	D ₈	E ₉	F ₁₀	G ₁₁	H ₁₂	I ₁₃
3209	3349	3439	3589	3809	3969	4139	4499	5049	5529	5999	

KAS28A with Thermofoil Arm Caps and Back Rail Cap

COM	Dillon	Carson	A ₅	B ₆	C ₇	D ₈	E ₉	F ₁₀	G ₁₁	H ₁₂	I ₁₃
3359	3459	3589	3699	3949	4139	4269	4629	5169	5749	6179	

*Contact customer service for solid surface pricing of arm caps or back rail caps (on applicable models).

KAS30 - 3 Seat Lounge Chair with 3.5" Arms

Dimensions

Overall			Seat		
W	D	H	W	D	H
74	27.75	31.75	66.5	19.125	18.375
			Back H	Arm H	
			14.5	25.25	

COM: 7 yds
 Wt Cap: 1000 lb
 Unit Weight: 126 lb

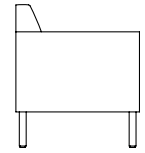
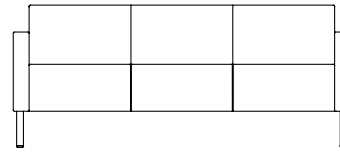

KAS30F with Fully Upholstered Arms

COM	Dillon	Carson	A ₅	B ₆	C ₇	D ₈	E ₉	F ₁₀	G ₁₁	H ₁₂	I ₁₃
3419	3599	3769	4009	4179	4559	4799	5219	5909	6449	6979	

KAS30A with Thermofoil Arm Caps

COM	Dillon	Carson	A ₅	B ₆	C ₇	D ₈	E ₉	F ₁₀	G ₁₁	H ₁₂	I ₁₃
3459	3649	3829	4079	4239	4569	4849	5269	6069	6579	7099	

*Contact customer service for solid surface pricing of arm caps or back rail caps (on applicable models).

KAS33 - 3 Seat Lounge Chair with 3.5" Arms & Boxed Back

Dimensions

Overall			Seat		
W	D	H	W	D	H
74	31.25	31.75	66.75	19.125	18.375
			Back H	Arm H	
			14.5	25.25	

COM: 7.5 yds
 Wt Cap: 1000 lb
 Unit Weight: 155 lb

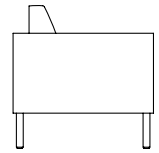
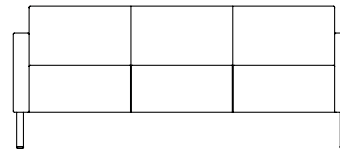

KAS33F with Fully Upholstered Arms

COM	Dillon	Carson	A ₅	B ₆	C ₇	D ₈	E ₉	F ₁₀	G ₁₁	H ₁₂	I ₁₃
3819	3959	4159	4349	4609	4899	5169	5629	6379	6849	7369	

KAS33A with Thermofoil Arm Caps and Back Rail Cap

COM	Dillon	Carson	A ₅	B ₆	C ₇	D ₈	E ₉	F ₁₀	G ₁₁	H ₁₂	I ₁₃
3939	4109	4289	4479	4749	5039	5289	5759	6509	6979	7629	

*Contact customer service for solid surface pricing of arm caps or back rail caps (on applicable models).

KAS38 - 3 Seat Lounge Chair with 8.5" Arms & Boxed Back

Dimensions

Overall			Seat		
W	D	H	W	D	H
85	31.25	31.75	66.75	19.125	18.375
			Back H	Arm H	
			14.5	25.25	

COM: 8 yds
 Wt Cap: 1000 lb
 Unit Weight: 176 lb

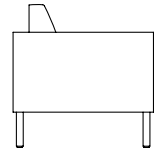
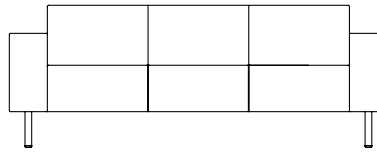

KAS38F with Fully Upholstered Arms

COM	Dillon	Carson	A ₅	B ₆	C ₇	D ₈	E ₉	F ₁₀	G ₁₁	H ₁₂	I ₁₃
3869	4009	4199	4399	4659	4969	5249	5669	6549	6979	7629	

KAS38A with Thermofoil Arm Caps and Back Rail Cap

COM	Dillon	Carson	A ₅	B ₆	C ₇	D ₈	E ₉	F ₁₀	G ₁₁	H ₁₂	I ₁₃
4029	4179	4359	4569	4819	5109	5389	5829	6699	7099	7629	

*Contact customer service for solid surface pricing of arm caps or back rail caps (on applicable models).

BEHAVIORAL HEALTH



General Product Information

- Utilizes tamper-resistant hardware
- Sled-style base
- Passive Flex Back
- Seat clean-out
- Wall-saver leg design
- Arms connected by heavy steel rails
- Molded seat foam on 21" seats
- Back foam: 1.7 density foam that meets CAL 117 Fire Standards
- Comfort webbing in seats
- Field replaceable components

To Order, Specify

- Model Number
- Textile
- Finish
- Options

Available Options

FRAME OPTIONS *See pg 2 for finishes*
**Standard in 540 Pewter finish*

ARM CAP OPTIONS *See pg 2 for finishes*

- U Urethane Standard on specified models
- F Fully Upholstered Arms Standard on specified models

ADDITIONAL FEATURES & OPTIONS

- M Additional Weight Specified models
- CAL CAL TB133 See pg 9
- Z Multi Cover Use Pricing for Highest Grade
- MB Moisture Barrier See pg 11

KOT19 - Behavioral Health Chair

Dimensions

Overall			Seat		
W	D	H	W	D	H
24.5	29.5	33.25	20.75	19.5	18.25
			Back H	Arm H	
			15	25.75	

COM: 2 yds
 Wt Cap: 550 lb
 Unit Weight: 62 lb

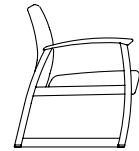
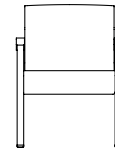

KOT19U with Urethane Arm Caps

COM	Dillon/Carson	A ₅	B ₆	C ₇	D ₈	E ₉	F ₁₀	G ₁₁	H ₁₂	I ₁₃
1849	1909	1929	1949	1979	2059	2119	2129	2219	2449	2629

KOT19-M - Behavioral Health Chair with Additional Weight

Dimensions

Overall			Seat		
W	D	H	W	D	H
24.5	29.5	33.25	20.75	19.5	18.25
			Back H	Arm H	
			15	25.75	

COM: 2 yds
 Wt Cap: 550 lb
 Unit Weight: 96 lb

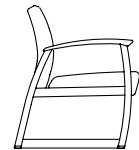
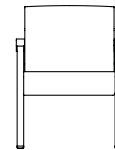

KOT19UM with Urethane Arm Caps

COM	Dillon/Carson	A ₅	B ₆	C ₇	D ₈	E ₉	F ₁₀	G ₁₁	H ₁₂	I ₁₃
2189	2219	2239	2299	2329	2389	2439	2469	2549	2759	2899

KOT29 - 2 Seat Behavioral Health Chair

Dimensions

Overall			Seat		
W	D	H	W	D	H
45.5	29.5	33.25	42	19.5	18.25
			Back H	Arm H	
			15	25.75	

COM: 3 yds
 Wt Cap: 750 lb
 Unit Weight: 95 lb

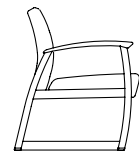
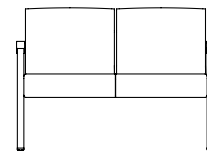

KOT29U with Urethane Arm Caps

COM	Dillon/Carson	A ₅	B ₆	C ₇	D ₈	E ₉	F ₁₀	G ₁₁	H ₁₂	I ₁₃
2879	2979	3019	3079	3129	3249	3369	3499	3649	3949	4199

KOT29I - 2 Seat Behavioral Health Chair with Intervening Arm

Dimensions

Overall			Seat		
W	D	H	W	D	H
47	29.5	33.25	20.75	19.5	18.25
			Back H	Arm H	
			15	25.75	

COM: 3 yds
 Wt Cap: 750 lb
 Unit Weight: 110 lb

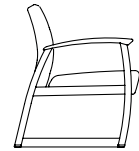
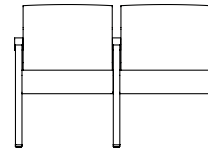

KOT29IU with Urethane Arm Caps

COM	Dillon/Carson	A ₅	B ₆	C ₇	D ₈	E ₉	F ₁₀	G ₁₁	H ₁₂	I ₁₃
3449	3549	3569	3719	3799	3889	4039	4119	4299	4549	4729

KOT39I - 3 Seat Behavioral Health Chair with Intervening Arms

Dimensions

Overall			Seat		
W	D	H	W	D	H
69.5	29.5	33.25	20.75	19.5	18.25
			Back H	Arm H	
			15	25.75	

COM: 4.5 yds
 Wt Cap: 1000 lb
 Unit Weight: 159 lb

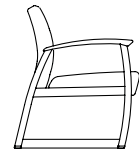
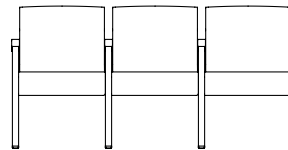

KOT39IU with Urethane Arm Caps

COM	Dillon/Carson	A ₅	B ₆	C ₇	D ₈	E ₉	F ₁₀	G ₁₁	H ₁₂	I ₁₃
4739	4969	5019	5049	5189	5359	5539	5649	5919	6319	6579

KOU19 - Behavioral Health Lounge Chair

Dimensions

Overall			Seat		
W	D	H	W	D	H
27.25	30	33.75	21.75	19	18
			Back H	Arm H	
			15.75	25	

COM: 4 yd
 Wt Cap: 550 lb
 Unit Weight: 88 lb

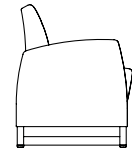
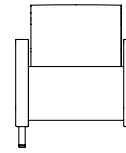

KOU19F Standard with Fully Upholstered Arms

COM	Dillon/Carson	A ₅	B ₆	C ₇	D ₈	E ₉	F ₁₀	G ₁₁	H ₁₂	I ₁₃
2569	2619	2639	2699	2799	2889	3059	3209	3529	3949	4199

KOU19-M - Behavioral Health Lounge Chair with Additional Weight

Dimensions

Overall			Seat		
W	D	H	W	D	H
27.25	30	33.75	21.75	19	18
			Back H	Arm H	
			15.75	25	

COM: 4 yd
 Wt Cap: 550 lb
 Unit Weight: 123 lb

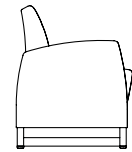
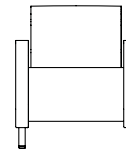

KOU19FM Standard with Fully Upholstered Arms (KOU19FM)

COM	Dillon/Carson	A ₅	B ₆	C ₇	D ₈	E ₉	F ₁₀	G ₁₁	H ₁₂	I ₁₃
2909	2949	2979	3039	3109	3219	3369	3529	3839	4199	4479

KOU29 - 2 Seat Behavioral Health Lounge Chair

Dimensions

Overall			Seat		
W	D	H	W	D	H
49.75	30	33.75	44	19	18
			Back H	Arm H	
			15.75	25	

COM: 5.5 yd
 Wt Cap: 750 lb
 Unit Weight: 126 lb

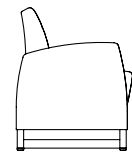
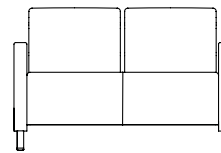

KOU29F Standard with Fully Upholstered Arms

COM	Dillon/Carson	A ₅	B ₆	C ₇	D ₈	E ₉	F ₁₀	G ₁₁	H ₁₂	I ₁₃
3719	3799	3819	3899	4009	4119	4249	4559	4879	5399	5789

KOU291 - 2 Seat Behavioral Health Lounge Chair with Intervening Arms

Dimensions

Overall			Seat		
W	D	H	W	D	H
51.75	30	33.75	21.75	19	18
			Back H	Arm H	
			15.75	25	

COM: 6.5 yd
 Wt Cap: 750 lb
 Unit Weight: 152 lb

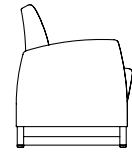
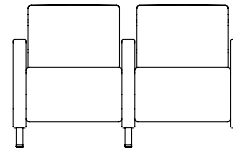

KOU291F Standard with Fully Upholstered Arms

COM	Dillon/Carson	A ₅	B ₆	C ₇	D ₈	E ₉	F ₁₀	G ₁₁	H ₁₂	I ₁₃
4469	4549	4559	4759	4969	5169	5349	5679	6289	6709	7099

KOU39 - 3 Seat Behavioral Health Lounge Chair

Dimensions

Overall			Seat		
W	D	H	W	D	H
71.75	30	33.75	66.5	19	18
			Back H	Arm H	
			15.75	25	

COM: 7.5 yd
 Wt Cap: 1000 lb
 Unit Weight: 161 lb

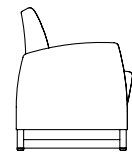
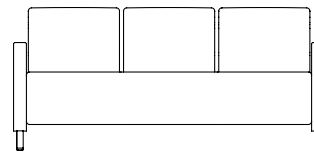

KOU39F Standard with Fully Upholstered Arms

COM	Dillon/Carson	A ₅	B ₆	C ₇	D ₈	E ₉	F ₁₀	G ₁₁	H ₁₂	I ₁₃
4629	4839	4849	4959	5239	5479	5679	6139	6619	7099	7629

KOU391 - 3 Seat Behavioral Health Lounge Chair with Intervening Arms

Dimensions

Overall			Seat		
W	D	H	W	D	H
76.25	30	33.75	21.75	19	18
			Back H	Arm H	
			15.75	25	

COM: 9 yd
 Wt Cap: 1000 lb
 Unit Weight: 208 lb

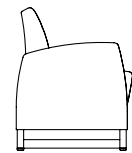
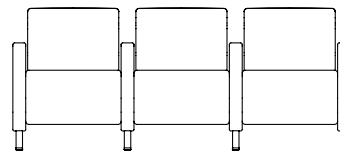

KOU391F Standard with Fully Upholstered Arms

COM	Dillon/Carson	A ₅	B ₆	C ₇	D ₈	E ₉	F ₁₀	G ₁₁	H ₁₂	I ₁₃
5999	6239	6299	6419	6719	7099	7409	7869	8649	9199	9869

RECLINERS

350 Series	86
450 Series	102
Durable® Series Recliners	106
Durable® 550 Series	111
Durable® 650 Series	118
Durable® 750 Series	136
Durable® Power Series	145
Durable® Exam Lift Series	152



How to Order

The chart below is a guide to use in building a recliner model number for ordering. Base models and their available aesthetic styles and options are listed in the following sections of 350 Series and 450 Series recliners. Specify textiles and finishes, along with any additional options from the following pages. Recliner base pricing is determined by selected textile grade. Option prices for each base model are listed on individual product pages, along with availability.

	Aesthetic Style	Base Model	Arms	Multicover	Caster System
EXAMPLE	K Kure	0107 Mobile Recliner	J Solid Surface Arm Caps	Z Multiple Covers Selected	S Two-Caster Lock & Steer
	<p>Denotes Back and Arm Design</p> <p>See individual product pages for available Aesthetic Styles.</p> <p>Products with limited aesthetic styles may include this letter with the base model number.</p>	<p>Denotes Base Functionality</p> <p>'C' in front of model number indicates 'Chaise Continuous Leg Support.'</p>	<p>Denotes Arm Cap Selection</p> <p>(F) Fully Upholstered Arms (no arm cap)</p> <p>(U) Urethane Arm Cap</p> <p>(J) Solid Surface Arm Cap</p>	<p>Denotes if Multiple Textiles Specified</p> <p>(Z) Multicover</p> <p>If entire unit is specified in a single textile, leave this space blank.</p>	<p>Denotes Caster System Selection</p> <p>(S) Two Caster Locking</p> <p>Not available on 350 Series models.</p> <p>If no caster system selected, leave this space blank. Casters that are not part of a two-caster locking system are able to be locked individually.</p>

**** See individual product pages for availability of above options.****

350 Series Aesthetic Styles

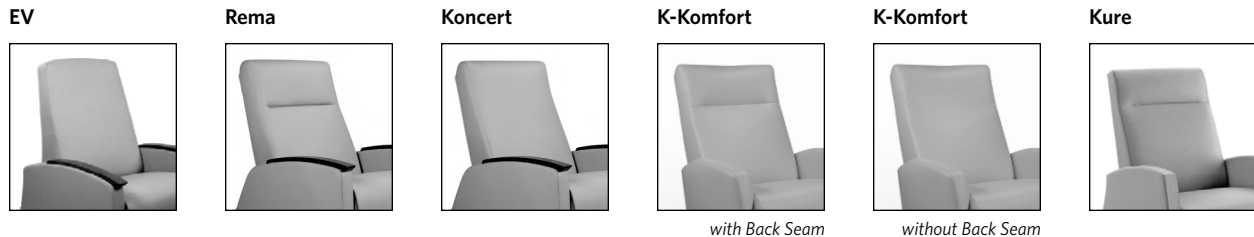

450 Series Aesthetic Styles

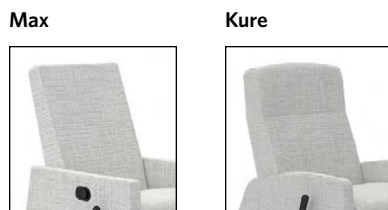

Recliner Dimension Key

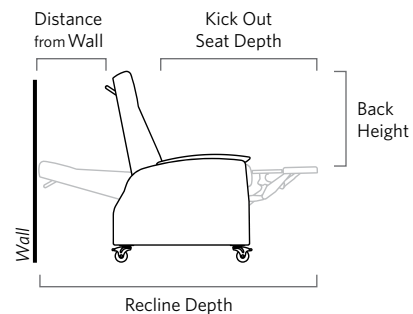

350 SERIES



Series Overview

Boasting several different designs and functionalities, the 350 Series is one of our broadest categories. With products designed specifically for controlled environments, such as senior living, wellness rooms, or office lounges, the 350 Series offers Gliders, Power Recliners, Three Position Recliners, and more. The common thread among all 350 Series models is the trusted comfort we have come to be known for.

General Product Information

- 350 lb Weight Rating
- Variety of stationary and mobile styles
- Power and manual operation styles
- Seat clean-out
- Field replaceable components

Options vary by model, see specific model page for list of available options

Refer to pg 107 for full option details and images

To Order, Specify

- Model Number
- Textile
- Finish
- Options

Recommended Applications

	Long-Term Care & Assisted Living	Women's & Children's	Wellness Room	Doctor's Lounge	Home Health
Three Position Recliner			●	●	
Glider Recliner (Manual)	●	●	●	●	
Glider Recliner (Power)	●	●	●	●	
Body Weight Activated Glider	●	●	●	●	
Room Saver™ Recliner (Manual)	●				
Room Saver™ Recliner (Power)	●				
Room Saver™ Recliner (Power/Lift)	●				
Standard Recliner (Stationary Models)	●		●	●	
Standard Recliner (Mobile Models)	●				
K-Komfort Recliners	●		●	●	●

*For recliners designed for acute care and other "uncontrolled" healthcare applications, refer to Durable® series:

- Durable® 550 - Rocker Recliner
- Durable® 650 - Mobile
- Durable® 750 - Bariatric Mobile
- Durable® Power - Power/Lift Assist
- Durable® Exam Lift - Exam Lift

350 SERIES

Three Position Recliner

Select Aesthetic Style (Denotes back & arm design)

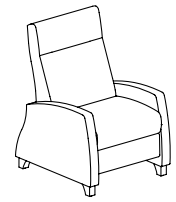
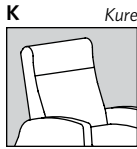

Select Functional Style (Aesthetic style code precedes selected model number below, e.g., RC1306)

0017 Kure Three Position Recliner

COM	Dillon/Carson	A ₅	B ₆	C ₇	D ₈	E ₉	F ₁₀	G ₁₁	H ₁₂	I ₁₃
3159	3199	3249	3379	3489	3609	3799	3979	4249	4599	4949

Dimensions

	Overall			Seat			Back H	Arm H	Kick Out Seat D	Recline D	Distance from Wall
	W	D	H	W	D	H					
K0017	28	37.5	44	22.5	20.5	19	23.5	25.5	41	67	17

General Info

COM: 4 yds

Wt Cap: 350 lb
Unit

Weight: 97 lb

Available Options

<p>ARM CAP OPTIONS See pg 2 for finishes</p> <p>F Fully Upholstered Arms Standard</p> <p>U Urethane 169</p> <p>J1 Solid Surface - Group 1 619</p> <p>J2 Solid Surface - Group 2 819</p> <p>CASTER & BASE OPTIONS</p> <p>CASTER 3" - Locking Casters 199</p> <p>WF Wood Legs Standard</p> <p>ADDITIONAL FEATURES & OPTIONS</p> <p>CAL CAL TB133 See pg 9</p> <p>Z Multi Cover Use Pricing for Highest Grade</p> <p>EG Protective Edge Guard Standard</p>	<p>PATIENT WELLNESS & COMFORT OPTIONS</p> <p>MBB Moisture Barrier (Back) See pg 11</p> <p>MBS Moisture Barrier (Seat) See pg 11</p> <p>TRAY TABLE OPTIONS</p> <p>LFSTR Large Folding (Right) Side Tray^{2,4} 249</p> <p>LFSTRCH Large Folding Cup Holder (Right) Side Tray^{2,4} 319</p> <p>PLFSTR Padded Large Folding (Right) Side Tray^{2,4} 379</p> <p>SFSTR Small Folding (Right) Side Tray^{2,4} 249</p> <p style="text-align: center;">*Refer to pg 107 for full option details and images*</p>
--	--

²Standard on right side (facing). Replace "R" with "L" for left side (facing) option where available.

⁴Contact customer service for solid surface pricing

350 SERIES

Glider Recliner | Manual

Select Aesthetic Style (Denotes back & arm design)

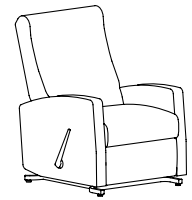
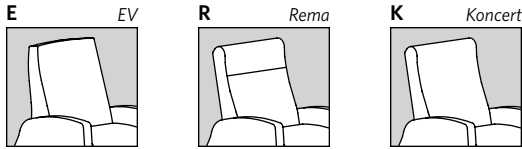

(Koncert style pictured)

Select Functional Style (Aesthetic style code precedes selected model number below, e.g., RC1306)

C1306 Chaise Glider Recliner

COM	Dillon/Carson	A ₅	B ₆	C ₇	D ₈	E ₉	F ₁₀	G ₁₁	H ₁₂	I ₁₃
3459	3579	3609	3859	4079	4119	4359	4599	5089	5399	5739

Dimensions

	Overall			Seat			Back H	Arm H	Kick Out Seat D	Recline D	Distance from Wall
	W	D	H	W	D	H					
EC1306	30.75	35.25	42	22.25	20.75	18.5	24.25	24.25	36.75	64.25	16.25
RC1306	30.75	35.25	42	22.25	20.75	18.5	24.25	24.25	36.75	64.25	16.25
KC1306	30.75	35.25	42	22.25	20.75	18.5	24.25	24.25	36.75	64.25	16.25

General Info
 COM: 5 yds
 Wt Cap: 350 lb
 Unit Weight: 94 lb

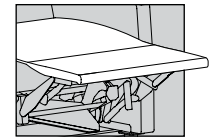

Chaise Continuous Leg Support

Available Options

ARM CAP OPTIONS

See pg 2 for finishes

F	Fully Upholstered Arms	Standard
U	Urethane	169
J1	Solid Surface - Group 1	619
J2	Solid Surface - Group 2	819

PATIENT WELLNESS & COMFORT OPTIONS

MBB	Moisture Barrier (Back)	See pg 11
MBS	Moisture Barrier (Seat)	See pg 11

ADDITIONAL FEATURES & OPTIONS

CAL	CAL TB133	See pg 9
Z	Multi Cover	Use Pricing for Highest Grade

Refer to pg 107 for full option details and images

350 SERIES

Glider Recliner | Power

Select Aesthetic Style (Denotes back & arm design)

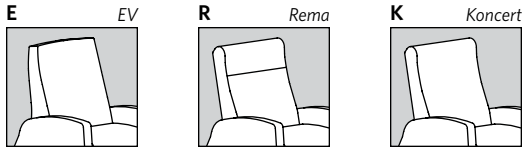

(Koncert style pictured)

Select Functional Style (Aesthetic style code precedes selected model number below, e.g., RC1306)

CFO1N0 Power Chaise Glider Recliner

COM	Dillon/Carson	A ₅	B ₆	C ₇	D ₈	E ₉	F ₁₀	G ₁₁	H ₁₂	I ₁₃
3419	3599	3739	3849	3979	4169	4319	4569	4919	5229	5579

Dimensions

	Overall			Seat			Back H	Arm H	Kick Out Seat D	Recline D	Distance from Wall
	W	D	H	W	D	H					
ECF01N0	28.5	36	39.25	22.25	21	18.25	24	25.5	37	65	15
RCF01N0	28.5	36	39.25	22.25	21	18.25	24	25.5	37	65	15
KCF01N0	28.5	36	39.25	22.25	21	18.25	24	25.5	37	65	15

General Info
 COM: 4.5 yds
 Wt Cap: 350 lb
 Unit Weight: 104 lb

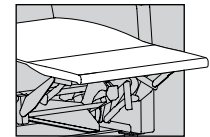

Chaise Continuous Leg Support

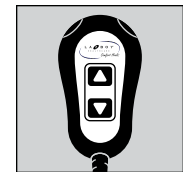

Power Recliner Wand

Available Options

ARM CAP OPTIONS

See pg 2 for finishes

F	Fully Upholstered Arms	Standard
U	Urethane	169
J1	Solid Surface - Group 1	619
J2	Solid Surface - Group 2	819

PATIENT WELLNESS & COMFORT OPTIONS

MBB	Moisture Barrier (Back)	See pg 11
MBS	Moisture Barrier (Seat)	See pg 11

ADDITIONAL FEATURES & OPTIONS

CAL	CAL TB133	See pg 9
Z	Multi Cover	Use Pricing for Highest Grade

Refer to pg 107 for full option details and images

350 SERIES

Body Weight Activated Glider

Select Aesthetic Style (Denotes back & arm design)

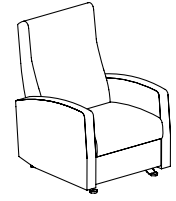
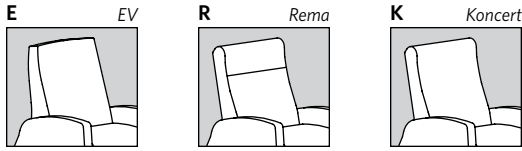

(Koncert style pictured)

Select Functional Style (Aesthetic style code precedes selected model number below, e.g., RC1306)

1716 Body Weight Activated Glider

COM	Dillon/Carson	A ₅	B ₆	C ₇	D ₈	E ₉	F ₁₀	G ₁₁	H ₁₂	I ₁₃
2789	2879	2939	3059	3199	3379	3599	3809	4109	4469	4739

Dimensions

	Overall			Seat			Back H	Arm H	Distance from Wall
	W	D	H	W	D	H			
E1716	30.25	34	42.5	22	21	18.75	27.5	25	12
R1716	30.25	34	42.5	22	21	18.75	26.5	25	12
K1716	30.25	34	42.5	22	21	18.75	26.5	25	12

General Info
 COM: 6 yds
 Wt Cap: 350 lb
 Unit Weight: 89 lb

Available Options

ARM CAP OPTIONS

See pg 2 for finishes

F	Fully Upholstered Arms	Standard
U	Urethane	169
J1	Solid Surface - Group 1	619
J2	Solid Surface - Group 2	819

PATIENT WELLNESS & COMFORT OPTIONS

MBB	Moisture Barrier (Back)	See pg 11
MBS	Moisture Barrier (Seat)	See pg 11

ADDITIONAL FEATURES & OPTIONS

CAL	CAL TB133	See pg 9
Z	Multi Cover	Use Pricing for Highest Grade

Refer to pg 107 for full option details and images

GOT00 Gliding Ottoman (designed to complement 1716 style gliders only)

COM	Dillon/Carson	A ₅	B ₆	C ₇	D ₈	E ₉	F ₁₀	G ₁₁	H ₁₂	I ₁₃
889	899	909	969	1009	1049	1129	1189	1269	1369	1449

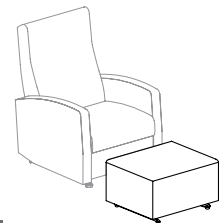

Dimensions

	Overall		
	W	D	H
	23.25	19.25	14.75

General Info
 COM: 2 yds
 Unit Weight: 29 lb

350 SERIES

Room Saver™ Recliner | Manual

Select Aesthetic Style (Denotes back & arm design)

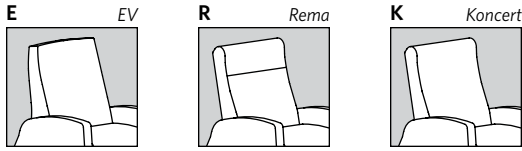

(Koncert style pictured)

Select Functional Style (Aesthetic style code precedes selected model number below, e.g., RC1306)

C1304 Room Saver™ Chaise Recliner

COM	Dillon/Carson	A ₅	B ₆	C ₇	D ₈	E ₉	F ₁₀	G ₁₁	H ₁₂	I ₁₃
3079	3139	3239	3409	3639	3869	4119	4449	4679	4999	5399

Dimensions

	Overall			Seat			Back H	Arm H	Kick Out Seat D	Recline D	Distance from Wall
	W	D	H	W	D	H					
EC1304	30.75	34.25	38.5	22.25	20	17.25	24	23.75	37.75	66.5	6
RC1304	30.75	34.25	38.5	22.25	20	17.25	24	23.75	37.75	66.5	6
KC1304	30.75	34.25	38.5	22.25	20	17.75	24	23.75	37.75	66.5	6

General Info
 COM: 5 yds
 Wt Cap: 350 lb
 Unit Weight: 82 lb

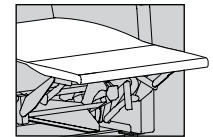

Chaise Continuous Leg Support

Available Options

ARM CAP OPTIONS

See pg 2 for finishes

F	Fully Upholstered Arms	Standard
U	Urethane	169
J1	Solid Surface - Group 1	619
J2	Solid Surface - Group 2	819

CASTER & BASE OPTIONS

LRSP	Large Room Saver™ Platform (adds 1" to height)	139
------	--	-----

ADDITIONAL FEATURES & OPTIONS

CAL	CAL TB133	See pg 9
Z	Multi Cover	Use Pricing for Highest Grade

PATIENT WELLNESS & COMFORT OPTIONS

MBB	Moisture Barrier (Back)	See pg 11
MBS	Moisture Barrier (Seat)	See pg 11

Refer to pg 107 for full option details and images

350 SERIES

Room Saver™ Recliner | Power

Select Aesthetic Style (Denotes back & arm design)

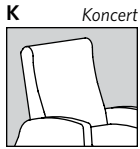

Select Functional Style (Aesthetic style code precedes selected model number below, e.g., RC1306)

C1P04 Power Room Saver™ Chaise Recliner

COM	Dillon/Carson	A ₅	B ₆	C ₇	D ₈	E ₉	F ₁₀	G ₁₁	H ₁₂	I ₁₃
3639	3689	3799	3939	4149	4359	4599	4889	5109	5399	5689

Dimensions

	Overall			Seat			Back H	Arm H	Kick Out Seat D	Recline D	Distance from Wall
	W	D	H	W	D	H					
KC1P04	30.75	34.25	38	22.25	20	17.25	23.5	23.75	37.75	65.5	5

General Info
 COM: 5 yds
 Wt Cap: 350 lb
 Unit Weight: 84 lb

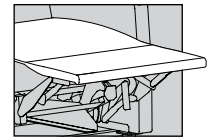

Chaise Continuous Leg Support

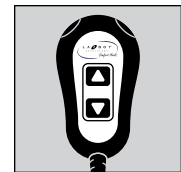

Power Recliner Wand

Available Options

ARM CAP OPTIONS

See pg 2 for finishes

F	Fully Upholstered Arms	Standard
U	Urethane	169
J1	Solid Surface - Group 1	619
J2	Solid Surface - Group 2	819

CASTER & BASE OPTIONS

LRSP	Large Room Saver™ Platform (adds 1" to height)	139
------	--	-----

ADDITIONAL FEATURES & OPTIONS

CAL	CAL TB133	See pg 9
Z	Multi Cover	Use Pricing for Highest Grade

PATIENT WELLNESS & COMFORT OPTIONS

MBB	Moisture Barrier (Back)	See pg 11
MBS	Moisture Barrier (Seat)	See pg 11

Refer to pg 107 for full option details and images

350 SERIES

Room Saver™ Recliner | Power & Lift

Select Aesthetic Style *(Denotes back & arm design)*

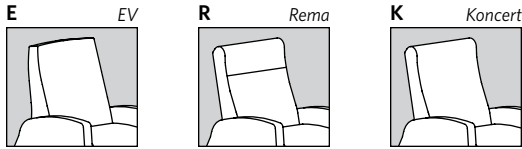

(Koncert style pictured)

Select Functional Style *(Aesthetic style code precedes selected model number below, e.g., RC1306)*

CH02NO Power & Lift Room Saver™ Chaise Recliner

COM	Dillon/Carson	A ₅	B ₆	C ₇	D ₈	E ₉	F ₁₀	G ₁₁	H ₁₂	I ₁₃
3639	3689	3799	3939	4149	4359	4599	4889	5109	5399	5689

Dimensions

	Overall			Seat			Back H	Arm H	Kick Out Seat D	Recline D	Distance from Wall
	W	D	H	W	D	H					
ECH02NO	30.75	34.25	39.5	22.25	20	17.25	23.5	23.75	38	65.5	5
RCH02NO	30.75	34.25	39.5	22.25	20	17.25	23.5	23.75	38	65.5	5
KCH02NO	30.75	34.25	39.5	22.25	20	17.25	23.5	23.75	38	65.5	5

General Info
 COM: 5 yds
 Wt Cap: 350 lb
 Unit Weight: 120 lb

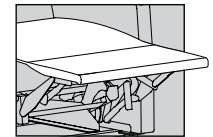

Chaise Continuous Leg Support



Power Recliner Wand

Available Options

ARM CAP OPTIONS

See pg 2 for finishes

F	Fully Upholstered Arms	Standard
U	Urethane	169
J1	Solid Surface - Group 1	619
J2	Solid Surface - Group 2	819

PATIENT WELLNESS & COMFORT OPTIONS

MBB	Moisture Barrier (Back)	See pg 11
MBS	Moisture Barrier (Seat)	See pg 11

ADDITIONAL FEATURES & OPTIONS

CAL	CAL TB133	See pg 9
Z	Multi Cover	Use Pricing for Highest Grade

Refer to pg 107 for full option details and images

350 SERIES

Standard Recliner | Stationary Power

Select Aesthetic Style (Denotes back & arm design)

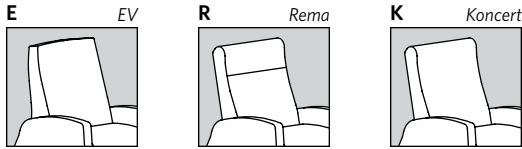

(Koncert style pictured)

Select Functional Style (Aesthetic style code precedes selected model number below, e.g., RC1306)

CE17NO Stationary Power Standard Chaise Recliner

COM	Dillon/Carson	A ₅	B ₆	C ₇	D ₈	E ₉	F ₁₀	G ₁₁	H ₁₂	I ₁₃
3419	3599	3689	3819	3949	4129	4289	4529	4869	5179	5529

Dimensions

	Overall			Seat			Back H	Arm H	Kick Out Seat D	Recline D	Distance from Wall
	W	D	H	W	D	H					
ECE17NO	28.5	36	41.5	22.25	21	19	24	25.5	37	66	15.5
RCE17NO	28.5	36	41.5	22.25	21	19	24	25.5	37	66	15.5
KCE17NO	28.5	36	41.5	22.25	21	19	24	25.5	37	66	15.5

General Info
 COM: 4.5 yds
 Wt Cap: 350 lb
 Unit Weight: 102 lb

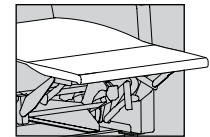

Chaise Continuous Leg Support

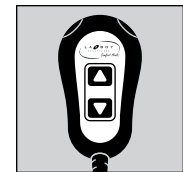

Power Recliner Wand

Available Options

ARM CAP OPTIONS

See pg 2 for finishes

F	Fully Upholstered Arms	Standard
U	Urethane	169
J1	Solid Surface - Group 1	619
J2	Solid Surface - Group 2	819

PATIENT WELLNESS & COMFORT OPTIONS

MBB	Moisture Barrier (Back)	See pg 11
MBS	Moisture Barrier (Seat)	See pg 11

ADDITIONAL FEATURES & OPTIONS

CAL	CAL TB133	See pg 9
Z	Multi Cover	Use Pricing for Highest Grade

Refer to pg 107 for full option details and images

350 SERIES

Standard Recliner | Mobile Power

Select Aesthetic Style (Denotes back & arm design)

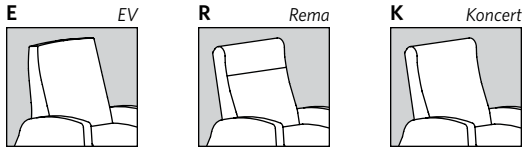

(Koncert style pictured)

Select Functional Style (Aesthetic style code precedes selected model number below, e.g., RC1306)

CE00NO Mobile Power Standard Chaise Recliner

COM	Dillon/Carson	A ₅	B ₆	C ₇	D ₈	E ₉	F ₁₀	G ₁₁	H ₁₂	I ₁₃
3629	3819	3929	4049	4209	4339	4529	4739	5049	5399	5739

Dimensions

	Overall			Seat			Back H	Arm H	Kick Out Seat D	Recline D	Distance from Wall
	W	D	H	W	D	H					
ECE00NO	28.5	36	42.5	22.25	21	20.5	24	28	37	66.5	18
RCE00NO	28.5	36	42.5	22.25	21	20.5	24	28	37	66.5	18
KCE00NO	28.5	36	42.5	22.25	21	20.5	24	28	37	66.5	18

General Info
 COM: 4.5 yds
 Wt Cap: 350 lb
 Unit Weight: 115 lb

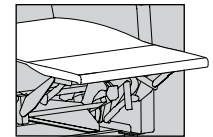

Chaise Continuous Leg Support

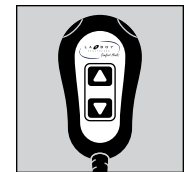

Power Recliner Wand

Available Options

ARM CAP OPTIONS

See pg 2 for finishes

F	Fully Upholstered Arms	Standard
U	Urethane	169
J1	Solid Surface - Group 1	619
J2	Solid Surface - Group 2	819

CASTER & BASE OPTIONS

3S1R3	3" - (3) Swivel/(1) Rigid Locking Casters	Standard
3S4	3" - (4) Swivel Locking Casters	19

ADDITIONAL FEATURES & OPTIONS

CAL	CAL TB133	See pg 9
Z	Multi Cover	Use Pricing for Highest Grade

PATIENT WELLNESS & COMFORT OPTIONS

MBB	Moisture Barrier (Back)	See pg 11
MBS	Moisture Barrier (Seat)	See pg 11

Refer to pg 107 for full option details and images

350 SERIES

Standard Recliner | Stationary Manual

Select Aesthetic Style (Denotes back & arm design)

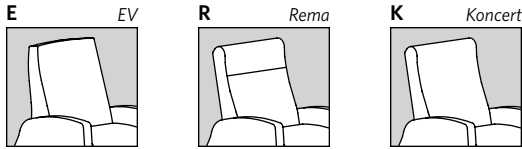

(Koncert style pictured)

Select Functional Style (Aesthetic style code precedes selected model number below, e.g., RC1306)

CD17N0 Stationary Manual Standard Chaise Recliner

COM	Dillon/Carson	A ₅	B ₆	C ₇	D ₈	E ₉	F ₁₀	G ₁₁	H ₁₂	I ₁₃
2979	3159	3269	3369	3499	3679	3839	4049	4399	4739	5049

Dimensions

	Overall			Seat			Back H	Arm H	Kick Out Seat D	Recline D	Distance from Wall
	W	D	H	W	D	H					
ECD17N0	30.75	36	41.5	22.25	21	19	24	25.5	37	66	15.5
RCD17N0	30.75	36	41.5	22.25	21	19	24	25.5	37	66	15.5
KCD17N0	30.75	36	41.5	22.25	21	19	24	25.5	37	66	15.5

General Info
 COM: 4.5 yds
 Wt Cap: 350 lb
 Unit Weight: 92 lb

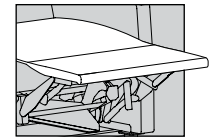

Chaise Continuous Leg Support

Available Options

ARM CAP OPTIONS

See pg 2 for finishes

F	Fully Upholstered Arms	Standard
U	Urethane	169
J1	Solid Surface - Group 1	619
J2	Solid Surface - Group 2	819

PATIENT WELLNESS & COMFORT OPTIONS

MBB	Moisture Barrier (Back)	See pg 11
MBS	Moisture Barrier (Seat)	See pg 11

ADDITIONAL FEATURES & OPTIONS

CAL	CAL TB133	See pg 9
Z	Multi Cover	Use Pricing for Highest Grade

Refer to pg 107 for full option details and images

350 SERIES

Standard Recliner | Mobile Manual

Select Aesthetic Style *(Denotes back & arm design)*

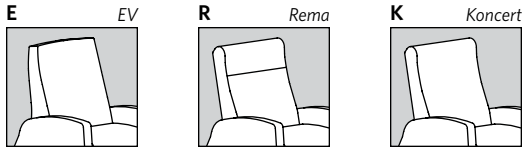

(Koncert style pictured)

Select Functional Style *(Aesthetic style code precedes selected model number below, e.g., RC1306)*

CD00N0 *Mobile Manual Standard Chaise Recliner*

COM	Dillon/Carson	A ₅	B ₆	C ₇	D ₈	E ₉	F ₁₀	G ₁₁	H ₁₂	I ₁₃
3369	3549	3629	3739	3899	4079	4199	4419	4799	5129	5469

Dimensions

	Overall			Seat			Back H	Arm H	Kick Out Seat D	Recline D	Distance from Wall
	W	D	H	W	D	H					
EC00N0	30.75	36	42.5	22.25	21	20.5	24	28	37	66.5	18
RCD00N0	30.75	36	42.5	22.25	21	20.5	24	28	37	66.5	18
KCD00N0	30.75	36	42.5	22.25	21	20.5	24	28	37	66.5	18

General Info

COM: 4.5 yds

Wt Cap: 350 lb
Unit Weight: 105 lb

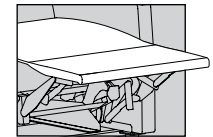

Chaise Continuous Leg Support

Available Options

ARM CAP OPTIONS

See pg 2 for finishes

F	Fully Upholstered Arms	Standard
U	Urethane	169
J1	Solid Surface - Group 1	619
J2	Solid Surface - Group 2	819

CASTER & BASE OPTIONS

3S1R3	3" - (3) Swivel/(1) Rigid Locking Casters	Standard
3S4	3" - (4) Swivel Locking Casters	19

ADDITIONAL FEATURES & OPTIONS

CAL	CAL TB133	See pg 9
Z	Multi Cover	Use Pricing for Highest Grade

PATIENT WELLNESS & COMFORT OPTIONS

MBB	Moisture Barrier (Back)	See pg 11
MBS	Moisture Barrier (Seat)	See pg 11

Refer to pg 107 for full option details and images

Select Aesthetic Style (Denotes back & arm design)

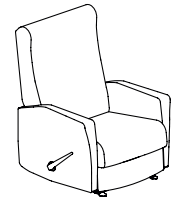
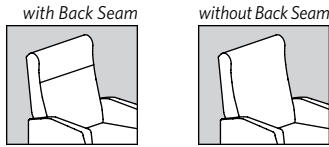

Select Functional Style

KC8004 K-Komfort Room Saver™™ Chaise Recliner with Back Seam

COM	Dillon/Carson	A ₅	B ₆	C ₇	D ₈	E ₉	F ₁₀	G ₁₁	H ₁₂	I ₁₃
2609	2669	2739	2889	3029	3179	3389	3629	3999	4349	4679

KC8014 K-Komfort Room Saver™ Chaise Recliner

COM	Dillon/Carson	A ₅	B ₆	C ₇	D ₈	E ₉	F ₁₀	G ₁₁	H ₁₂	I ₁₃
2509	2569	2669	2789	2949	3119	3289	3529	3849	4219	4579

Dimensions

	Overall			Seat			Back H	Arm H	Kick Out Seat D	Recline D	Distance from Wall
	W	D	H	W	D	H					
KC8004 KC8014	32	35	40.5	23	21	18	27.5	23.5	37	64	6

General Info
 COM: 6 yds
 Wt Cap: 350 lb
 Unit Weight: 86 lb

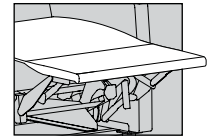

Chaise Continuous Leg Support

Available Options

ARM OPTIONS

F Fully Upholstered Arms Standard

BASE OPTIONS

LRSP Large Room Saver™ Platform (adds 1" to height) 139

ADDITIONAL FEATURES & OPTIONS

CAL CAL TB133 See pg 9
 Z Multi Cover Use Pricing for Highest Grade
 MBB Moisture Barrier (Back) See pg 11
 MBS Moisture Barrier (Seat) See pg 11

Select Aesthetic Style (Denotes back & arm design)

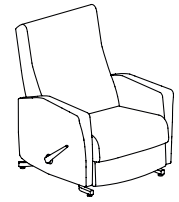
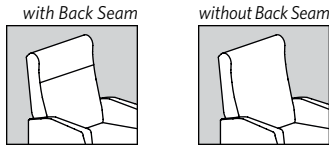

Select Functional Style

KC8006 K-Komfort Chaise Glider Recliner with Back Seam

COM	Dillon/Carson	A ₅	B ₆	C ₇	D ₈	E ₉	F ₁₀	G ₁₁	H ₁₂	I ₁₃
2829	2859	2959	3089	3239	3409	3589	3829	4159	4459	4729

KC8016 K-Komfort Chaise Glider Recliner

COM	Dillon/Carson	A ₅	B ₆	C ₇	D ₈	E ₉	F ₁₀	G ₁₁	H ₁₂	I ₁₃
2759	2829	2899	3009	3199	3369	3539	3789	4099	4459	4729

Dimensions

	Overall			Seat			Back H	Arm H	Kick Out Seat D	Recline D	Distance from Wall
	W	D	H	W	D	H					
KC8006 KC8016	32	36	40.5	23	21	18.5	27.5	24.5	37	64	16.5

General Info
 COM: 6 yds
 Wt Cap: 350 lb
 Unit
 Weight: 92 lb

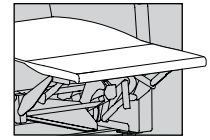

Chaise Continuous Leg Support

Available Options

ARM OPTIONS

F	Fully Upholstered Arms	Standard
---	------------------------	----------

ADDITIONAL FEATURES & OPTIONS

CAL	CAL TB133	See pg 9
Z	Multi Cover	Use Pricing for Highest Grade
MBB	Moisture Barrier (Back)	See pg 11
MBS	Moisture Barrier (Seat)	See pg 11

350 SERIES | K-KOMFORT

Room Saver™ Recliner | Power

Select Aesthetic Style (Denotes back & arm design)

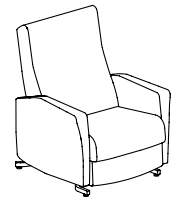
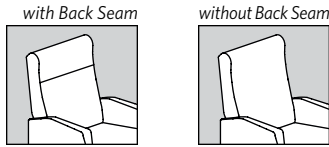

Select Functional Style

KC8P04 K-Komfort Room Saver™ Power Chaise Recliner with Back Seam

COM	Dillon	Carson	A ₅	B ₆	C ₇	D ₈	E ₉	F ₁₀	G ₁₁	H ₁₂	I ₁₃
3429	3459	3549	3659	3839	3979	4199	4449	4629	4949	5269	

KC8P14 K-Komfort Room Saver™ Power Chaise Recliner

COM	Dillon	Carson	A ₅	B ₆	C ₇	D ₈	E ₉	F ₁₀	G ₁₁	H ₁₂	I ₁₃
3349	3369	3419	3599	3769	3869	4069	4319	4539	4869	5199	

Dimensions

	Overall			Seat			Back H	Arm H	Kick Out Seat D	Recline D	Distance from Wall
	W	D	H	W	D	H					
KC8P04 KC8P14	30.75	35	39.5	22.25	21	18.5	27.5	24.5	38	65.5	5

General Info
 COM: 4.5 yds
 Wt Cap: 350 lb
 Unit Weight: 96 lb

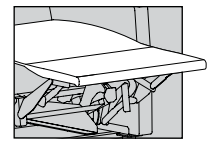

Chaise Continuous Leg Support

Available Options

ARM OPTIONS

F	Fully Upholstered Arms	Standard
---	------------------------	----------

ADDITIONAL FEATURES & OPTIONS

CAL	CAL TB133	See pg 9
Z	Multi Cover	Use Pricing for Highest Grade
MBB	Moisture Barrier (Back)	See pg 11
MBS	Moisture Barrier (Seat)	See pg 11



Power Recliner Wand

350 SERIES | K-KOMFORT

Room Saver™ Recliner | Power & Lift

Select Aesthetic Style (Denotes back & arm design)

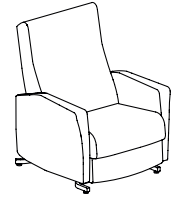
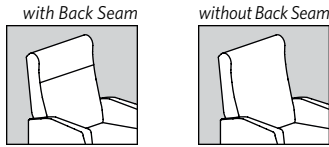

Select Functional Style

KC8L04 K-Komfort Room Saver™ Power & Lift Chaise Recliner with Back Seam

COM	Dillon	Carson	A ₅	B ₆	C ₇	D ₈	E ₉	F ₁₀	G ₁₁	H ₁₂	I ₁₃
3429	3459	3549	3659	3839	3979	4199	4449	4629	4999	5339	

KC8L14 K-Komfort Room Saver™ Power & Lift Chaise Recliner

COM	Dillon	Carson	A ₅	B ₆	C ₇	D ₈	E ₉	F ₁₀	G ₁₁	H ₁₂	I ₁₃
3349	3369	3419	3599	3769	3869	4069	4319	4539	4869	5199	

Dimensions

	Overall			Seat			Back H	Arm H	Kick Out Seat D	Recline D	Distance from Wall
	W	D	H	W	D	H					
KC8L04 KC8L14	30.5	35	39.5	22.25	21	18.5	27.5	24.5	38	65.5	5

General Info
 COM: 4.5 yds
 Wt Cap: 350 lb
 Unit Weight: 120 lb

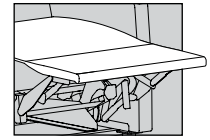

Chaise Continuous Leg Support

Available Options

ARM OPTIONS

F	Fully Upholstered Arms	Standard
---	------------------------	----------

ADDITIONAL FEATURES & OPTIONS

CAL	CAL TB133	See pg 9
Z	Multi Cover	Use Pricing for Highest Grade
MBB	Moisture Barrier (Back)	See pg 11
MBS	Moisture Barrier (Seat)	See pg 11

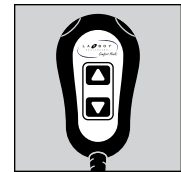

Power Recliner Wand

450 SERIES



Series Overview

The 450 Series is our entry-level recliner offering for uncontrolled healthcare environments. Available in Max and Kure aesthetic styles, the 450 Series utilizes independent leg support and back angle adjustments. Both styles are available with several of our most popular “add-on” options to make them a practical choice for a utility recliner when price is a concern, while not sacrificing quality or comfort.

General Product Information

- 450 lb Weight Rating
- Designed for 24/7 use healthcare environments
- Manually operated recline functionality
- Independent footrest and back adjustment
- Seat Foam Density: 2.3 High Resiliency
- Back Foam Density: 1.75 High Resiliency
- Seat clean-out
- Mid-Ottoman Calf Support
- Infinite Position Back reclines to infinite angle positions
- All interior plywood California Carb Compliant/Phase II
- Field replaceable components

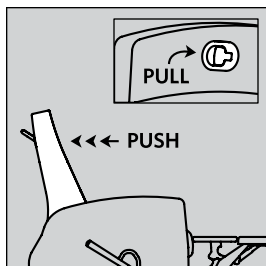

Infinite Position Locking Back

Allows patient/caregiver to lock back into any position. Lock lever located inside left (facing) arm on applicable models, unless otherwise noted/pictured.

To Order, Specify

- Model Number
- Textile
- Finish
- Options

Options vary by model, see specific model page for list of available options

Refer to pg 107 for full option details and images

450 SERIES

Mobile Healthcare Recliners

K0107 - Kure Mobile Healthcare Recliner - Infinite Position Locking Back



Pricing

COM	Dillon	Carson	A ₅	B ₆	C ₇	D ₈	E ₉	F ₁₀	G ₁₁	H ₁₂	I ₁₃
3449	3459	3549	3649	3849	3959	4139	4369	5769	6049	6369	

Dimensions

Overall			Seat			Back H	Arm H	Kick Out Seat D	Recline D	Distance from Wall
W	D	H	W	D	H					
30	37	44.5	22.5	21	20	24.5	26	37.5	71	20

General Info	
COM:	4.5 yds
Wt Cap:	450 lb
Unit Weight:	118 lb

Available Options

<p>ARM CAP OPTIONS <i>See pg 2 for finishes</i></p> <p>U Urethane 169</p> <p>J1 Solid Surface - Group 1 619</p> <p>J2 Solid Surface - Group 2 819</p> <p>F Fully Upholstered Arms Standard</p> <p>CASTER OPTIONS</p> <p>S4 4" - (2) Caster Lock & Steer System 569</p> <p>4S3R1 4" - (3) Swivel/(1) Rigid Locking Casters Standard</p> <p>4S4 4" - (4) Swivel Locking Casters 39</p> <p>ADDITIONAL FEATURES & OPTIONS</p> <p>EG Protective Edge Guard Standard</p> <p>QR Additional Quick Release Accessory Bracket 69</p> <p>CAL CAL TB133 See pg 9</p> <p>Z Multi Cover Use Pricing for Highest Grade</p> <p>PB Push Bar Standard</p>	<p>PATIENT WELLNESS & COMFORT OPTIONS</p> <p>AHP Adjustable Head Rest Pillow (COM 1 yd) 339</p> <p>DP Dual IV Poles & Brackets¹ 498</p> <p>FBH Foley Bag Holder 89</p> <p>FT Foot Tray 279</p> <p>IV IV Pole & Bracket¹ 249</p> <p>MBB Moisture Barrier (Back) 59</p> <p>MBS Moisture Barrier (Seat) 59</p> <p>MR Monitor Arm (right side facing)^{1,2} 849</p> <p>MTR Monitor Arm with Tray (right side facing)^{1,2} 949</p> <p>WR Wrist Restraint Mounts (pair) 229</p> <p>TRAY TABLE OPTIONS</p> <p>TSR1 Adjustable (Right) Side Tray^{1,2,5} 399</p> <p>TD3 Dual Adjustable Side Trays (TSR1 & TSL1)^{1,5} 798</p> <p>LFSTR Large Folding (Right) Side Tray⁴ 249</p> <p>LFSTRCH Large Folding Cup Holder (Right) Side Tray 319</p> <p>PLFSTR Padded Large Folding (Right) Side Tray 379</p> <p>SFSTR Small Folding (Right) Side Tray⁴ 249</p>
---	--

Refer to pg 107 for full option details and images

¹Includes QR bracket connection installed on recliner

²Standard on right side (facing). Replace "R" with "L" for left side (facing) option where available.

⁴Contact customer service for solid surface pricing

⁵Over the lap tray function recommended in seated position.

K0167 - Kure Mobile Healthcare Recliner - Infinite Position Locking Back - Single Fold Down Arm



Pricing

COM	Dillon	Carson	A ₅	B ₆	C ₇	D ₈	E ₉	F ₁₀	G ₁₁	H ₁₂	I ₁₃
4059	4069	4139	4209	4409	4529	4689	4899	6379	6699	7049	

Dimensions

Overall			Seat			Back H	Arm H	Kick Out Seat D	Recline D	Distance from Wall
W	D	H	W	D	H					
30	37	44.5	22.5	21	20	24.5	26	37.5	71	20

General Info
 COM: 5 yds
 Wt Cap: 450 lb
 Unit Weight: 138 lb

NOTE: Transfer arm standard on right side (facing). If specified on left side, handle will be placed on right side and vice versa.

Available Options

<p>ARM CAP OPTIONS See pg 2 for finishes</p> <p>U Urethane Standard</p> <p>J1 Solid Surface - Group 1 619</p> <p>J2 Solid Surface - Group 2 819</p> <p>CASTER OPTIONS</p> <p>S4 4" - (2) Caster Lock & Steer System 569</p> <p>4S3R1 4" - (3) Swivel/(1) Rigid Locking Casters Standard</p> <p>4S4 4" - (4) Swivel Locking Casters 39</p> <p>ADDITIONAL FEATURES & OPTIONS</p> <p>EG Protective Edge Guard Standard</p> <p>QR Additional Quick Release Accessory Bracket 69</p> <p>CAL CAL TB133 See pg 9</p> <p>Z Multi Cover Use Pricing for Highest Grade</p> <p>PB Push Bar Standard</p>	<p>PATIENT WELLNESS & COMFORT OPTIONS</p> <p>AHP Adjustable Head Rest Pillow (COM 1 yd) 339</p> <p>DP Dual IV Poles & Brackets¹ 498</p> <p>FBH Foley Bag Holder 89</p> <p>FT Foot Tray 279</p> <p>IV IV Pole & Bracket¹ 249</p> <p>MBB Moisture Barrier (Back) 59</p> <p>MBS Moisture Barrier (Seat) 59</p> <p>MR Monitor Arm (right side facing)^{1,2} 849</p> <p>MTR Monitor Arm with Tray (right side facing)^{1,2} 949</p> <p>FOLD DOWN TRANSFER ARM SPECIFIC</p> <p>HC Hinge Cover Standard</p>
---	---

Refer to pg 107 for full option details and images

¹Includes QR bracket connection installed on recliner
²Standard on right side (facing). Replace "R" with "L" for left side (facing) option where available.

450 SERIES

Mobile Healthcare Recliners

M0107 - Max Mobile Healthcare Recliner - Infinite Position Locking Back

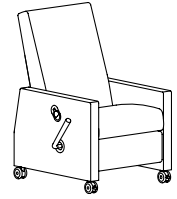

Pricing

COM	Dillon/Carson	A ₅	B ₆	C ₇	D ₈	E ₉	F ₁₀	G ₁₁	H ₁₂	I ₁₃
2929	2979	3009	3169	3369	3519	3769	4039	5389	5659	5969

Dimensions

Overall			Seat			Back H	Arm H	Kick Out Seat D	Recline D	Distance from Wall
W	D	H	W	D	H					
32.75	33.5	44	22.5	20	19.5	24.5	25	38	70	18

General Info	
COM:	4.5 yds
Wt Cap:	450 lb
Unit Weight:	98.3 lb

Available Options

<p>ARM CAP OPTIONS <i>See pg 2 for finishes</i></p> <p>U Urethane 169</p> <p>J1 Solid Surface - Group 1 619</p> <p>J2 Solid Surface - Group 2 819</p> <p>F Fully Upholstered Arms Standard</p> <p>T Thermofoil 119</p> <p>CASTER OPTIONS</p> <p>3S4 3" - Swivel Locking Casters Standard <i>*Not intended for transport.</i></p> <p>ADDITIONAL FEATURES & OPTIONS</p> <p>EG Protective Edge Guard Standard</p> <p>QR Additional Quick Release Accessory Bracket 69</p> <p>CAL CAL TB133 See pg 9</p> <p>Z Multi Cover Use Pricing for Highest Grade</p>	<p>PATIENT WELLNESS & COMFORT OPTIONS</p> <p>FBH Foley Bag Holder 89</p> <p>MBB Moisture Barrier (Back) 59</p> <p>MBS Moisture Barrier (Seat) 59</p> <p>MR Monitor Arm (right side facing)^{1,2} 849</p> <p>MTR Monitor Arm with Tray (right side facing)^{1,2} 949</p> <p>WR Wrist Restraint Mounts (pair) 229</p> <p>TRAY TABLE OPTIONS</p> <p>TSR1 Adjustable (Right) Side Tray^{1,2,5} 399</p> <p>TD3 Dual Adjustable Side Trays (TSR1 & TSL1)^{1,5} 798</p> <p>LFSTR Large Folding (Right) Side Tray⁴ 249</p> <p>LFSTRCH Large Folding Cup Holder (Right) Side Tray 319</p> <p>PLFSTR Padded Large Folding (Right) Side Tray 379</p> <p>SFSTR Small Folding (Right) Side Tray⁴ 249</p>
---	---

Refer to pg 107 for full option details and images

¹Includes QR bracket connection installed on recliner
²Standard on right side (facing). Replace "R" with "L" for left side (facing) option where available.

⁴Contact customer service for solid surface pricing
⁵Over the lap tray function recommended in seated position.

How to Order

The chart below is a guide to use in building a recliner model number for ordering. Base models and their available aesthetic styles and options are listed in the following sections of Durable® Series healthcare recliners. Specify textiles and finishes, along with any additional options from the following pages. Recliner base pricing is determined by selected textile grade. Option prices for each base model are listed on individual product pages, along with availability.

	Aesthetic Style	Base Model	Arms	Multicover	Heat/Massage	Caster System
EXAMPLE	KM Kadia Mod	1117 Mobile Healthcare Recliner	J Solid Surface Arm Caps	Z Multiple Covers Selected	HM Heat & Massage	Q Central Locking
	<p>Denotes Back and Arm Design</p> <p>See individual product pages for available Aesthetic Styles.</p> <p>Images of all styles within Durable® Series shown below.</p>	<p>Denotes Base Functionality</p> <p>'C' in front of model number indicates 'Chaise Continuous Leg Support.'</p> <p>Chart below lists each Durable® recliner series.</p>	<p>Denotes Arm Cap Selection</p> <p>(F) Fully Upholstered Arms (no arm cap)</p> <p>(U) Urethane Arm Cap</p> <p>(J) Solid Surface Arm Cap</p> <p>(T) Thermofoil Arm Cap</p>	<p>Denotes if Multiple Textiles Specified</p> <p>(Z) Multicover</p> <p>If entire unit is specified in a single textile, leave this space blank.</p>	<p>Denotes Heat and Massage Selection</p> <p>(H) Heat</p> <p>(HM) Heat & Massage</p> <p>Above codes still apply to model number when wand controlled option is selected (HW, HMW). Note HW or HMW with other options when ordering to specify.</p> <p>If no heat or massage option selected, leave this space blank.</p>	<p>Denotes Caster System Selection</p> <p>(Q)* Central Locking</p> <p>(S) Two Caster Locking</p> <p>*Use for any caster system containing 'Q'</p> <p>If no caster system selected, leave this space blank. Casters that are not part of a central or two-caster locking system are able to be locked individually.</p>

**** See individual product pages for availability of above options.****

Durable® Series Aesthetic Styles

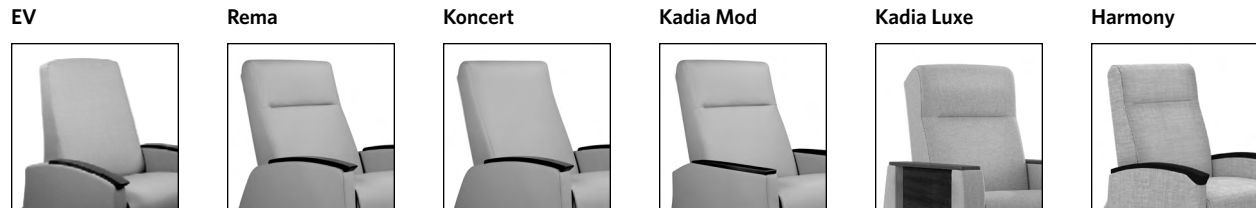

Durable® Series Healthcare Recliners by Category

550 Series	Rocker Recliners
650 Series	Mobile Recliners
750 Series	Mobile Bariatric Recliners
Power Series	Power / Lift Assist Mobile Recliners
Exam Lift Series	Exam Lift Treatment Recliners

Recliner Dimension Key

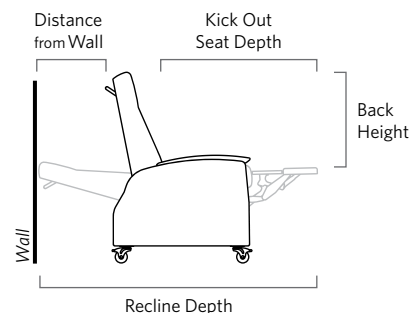

Arm Cap Options

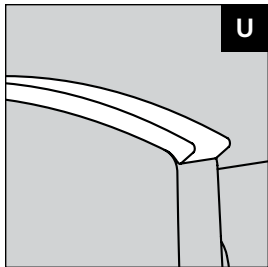

Urethane

Available in multiple styles (refer to product page for availability). See pg 2 for finishes.

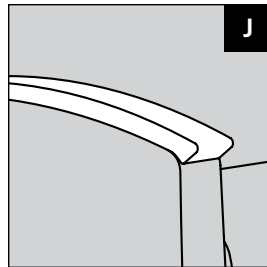

Solid Surface

Available in multiple styles (refer to product page for availability). See pg 2 for standard Group 1 and Group 2 finishes. Additional solid surface finishes are able to be specified, contact customer service for pricing.

Caster Options

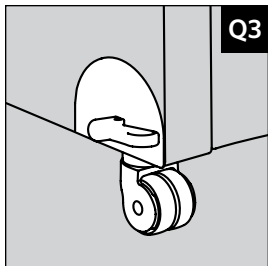

3" Dual Wheel Central Locking Caster System

Controlled by 2-position lever located at front of chair on left (facing) arm.

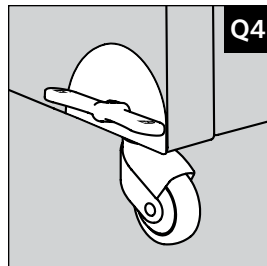

4" Central Lock & Steer Caster System

Controlled by 3-position lever located at front of chair on left (facing) arm. Steer setting locks rear casters to forward-facing orientation. Neutral setting allows all casters to swivel freely. Lock setting locks recliner into stationary position.

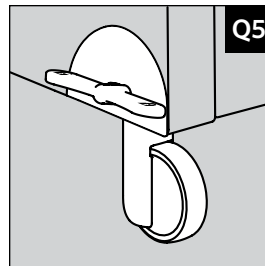

5" Central Lock & Steer Caster System

Controlled by 3-position lever located at front of chair on left (facing) arm. Steer setting locks rear casters to forward-facing orientation. Neutral setting allows all casters to swivel freely. Lock setting locks recliner into stationary position.

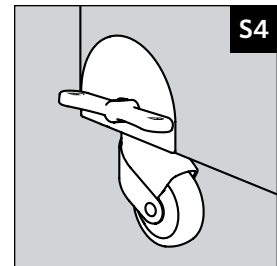

4" Two Caster Lock & Steer

Controlled by 3-position lever located at back of chair on left (facing) arm. Steer setting locks rear casters to forward-facing orientation. Neutral setting allows all casters to swivel freely. Lock setting locks recliner into stationary position.

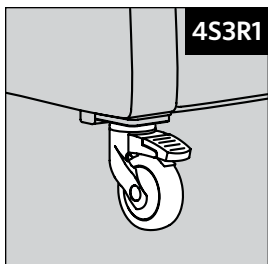

4" (3) Swivel / (1) Rigid Individual Locking Casters

All casters lock individually with lock tabs attached to each caster. Right front caster remains in forward facing orientation to aid in forward movement. Three remaining casters swivel 360 degrees.

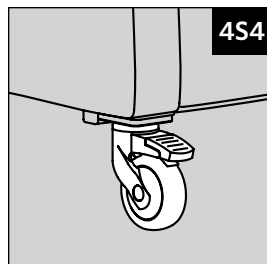

4" (4) Swivel Individual Locking Casters

All casters lock individually with lock tabs attached to each caster. All four casters swivel 360 degrees.

Note: Selecting a different caster size option than the standard on a particular model will increase or decrease the recliner seat height by the difference in caster sizes. (E.g., Exam Lift Recliners with standard 3" casters will have two inches added to seat height when the Q5 option is specified).

Heat & Massage Options

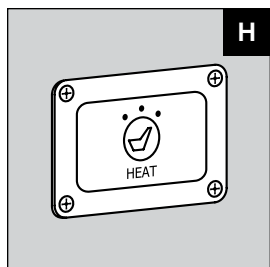

**Heat
(In-Arm Controls)**

IEC 60601-1 Certified.
Controls located inside left (facing) arm. Includes 10' cord with ground plug. Three heat settings, ranging 97° low to 105° high. Automatic shutoff after one hour.

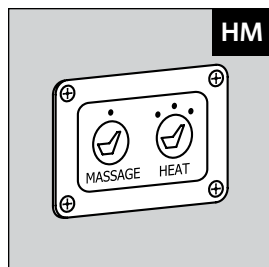

**Heat & Massage
(In-Arm Controls)**

IEC 60601-1 Certified.
Controls located inside left (facing) arm. Includes 10' cord with ground plug. Three heat settings, ranging 97° low to 105° high. Automatic shutoff after one hour (Heat) or 15 minutes (Massage).

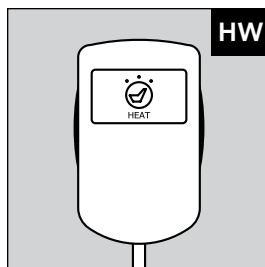

**Heat
(Wand Controls)**

IEC 60601-1 Certified.
Controls located on attached control wand. Includes 10' cord with ground plug. Three settings, ranging 97° low to 105° high. Automatic shutoff after one hour.

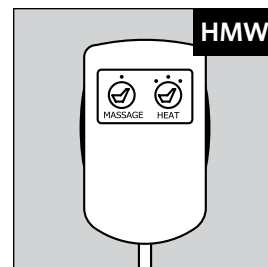

**Heat & Massage
(Wand Controls)**

IEC 60601-1 Certified.
Controls located on attached control wand. Includes 10' cord with ground plug. Three settings, ranging 97° low to 105° high. Automatic shutoff after one hour (Heat) or 15 minutes (Massage).

Patient Wellness & Comfort Options

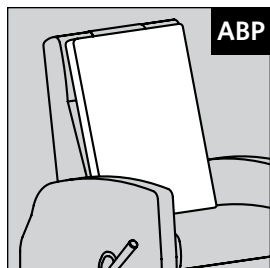

Adjustable Back Pad

Pad comprised of memory foam, adds additional cushioning to back. Two styles to match recliner back shape.
E models: ABP-E
R, K, KM/L, H, wingback models: ABP-R
COM requires 1.75 yds.

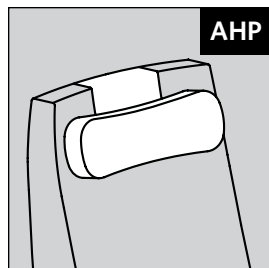

Adjustable Head Rest Pillow

Pillow comprised of memory foam. Weighted strap slides through push bar on back of recliner to hold pillow in desired position. Pillow and strap both upholstered in same textile as recliner back.
COM requires 1 yd.

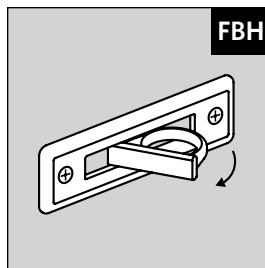

Foley Bag Holder

Accommodates Foley bags and other drainage bags. Closes flush with recliner when not in use. Located in arm opposite of handle side near front.

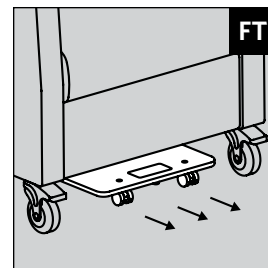

Foot Tray

Connected foot tray pulls out to support user's feet in seated position (not intended as step). Slides underneath recliner when not in use.

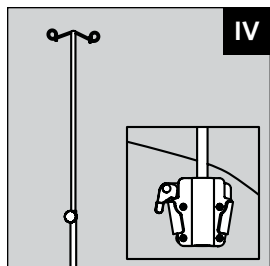

IV Pole & Bracket

Positioned on right (facing) arm toward back. IV pole is height adjustable. Attached via included QR Bracket.
Dual IV Poles (right/left): DP



LiquiCell

Aids in process of helping prevent pressure ulcers. Installed in seat (underneath textile), ultra-thin cells containing liquid that is in constant motion in order to reduce shear and friction for user. Included at no charge on recliners specified with Heat & Massage or Heat options.

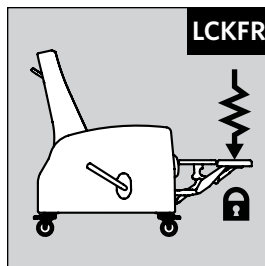

Orthopedic Locking Footrest

Recliner footrest locks completely into position when engaged and can only be adjusted with recline handle (or control wand on power models). Helps prevent unintentional movement of user's lower body/abdomen.

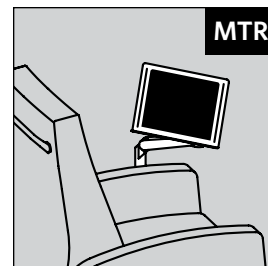

Monitor Arm with Tray

Adjustable arm designed to hold tablet or screen. Attached to recliner arm via included QR Bracket, standard on right side (facing). Tray/monitor connects to arm with VESA bracket.
Left side (facing): MTL
Right side (facing), w/o Tray: MR
Left side (facing), w/o Tray: ML

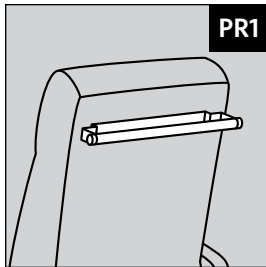

Paper Roll Holder
Accommodates exam paper rolls up to 21.25" wide. Takes place of Push Bar. Paper roll sold separately.

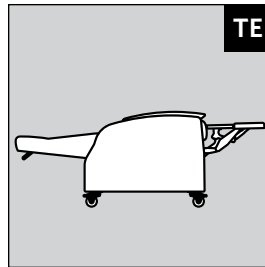

Trendelenburg
Allows additional 10° recline pitch in order to elevate user's feet above head. Engaged via non-handed foot pedal (or control wand on power models).

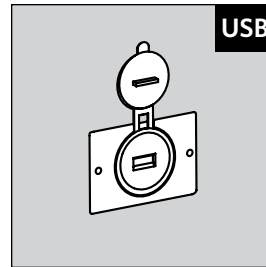

USB Power Outlet
IEC 60601-1 Certified.
Supplies power via USB-A port. Connected rubber plug provides protection to port when cleaning. Standard position on right (facing) arm.

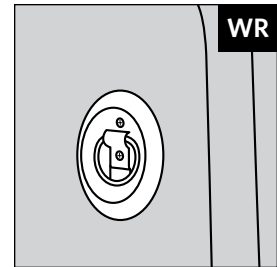

Wrist Restraint Mounts
Located on outside of arms (both sides). Metal loops accommodate wrist restraints.

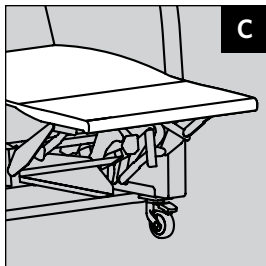

Chaise Continuous Leg Support
Continuous upholstery from back of seat to end of footrest. (Non-chaise leg support utilizes separately upholstered mid-ottoman and footrest pieces)

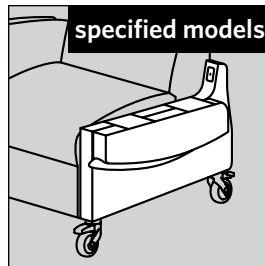

Fold Down Transfer Arm
Allows lateral transfer of patient. Folding portion of arm is released by spring-loaded pull lever on back of arm. Available in left, right, or dual side configurations. When arm is in down position, adds 4" to overall width of recliner.

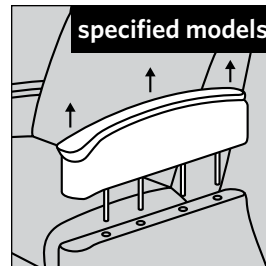

Removable Transfer Arm
Allows lateral transfer of patient. Available in left, right, or dual side configurations.

Tray Table Options

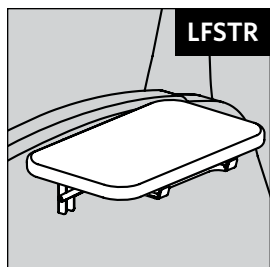

Large Folding Side Tray
Folds out to reveal table surface, standard on right side (facing). Measures 17" L x 10.7" W. Extends 2.5" from chair arm when in down position.
Left side (facing): LFSTL

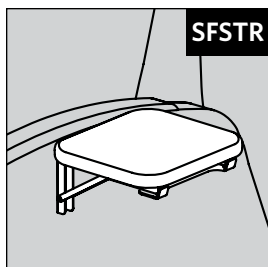

Small Folding Side Tray
Folds out to reveal table surface, standard on right side (facing). Measures 12" L x 10.7" W. Extends 2.5" from chair arm when in down position.
Left side (facing): SFSTL

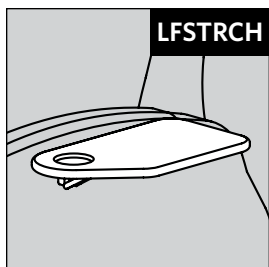

Large Folding Cup Holder Side Tray
Folds out to reveal table surface with recessed area to accommodate beverage, standard on right side (facing). Measures 23" L x 10.7" W. Extends 2.5" from chair arm when in down position.
Left side (facing): LFSTLCH

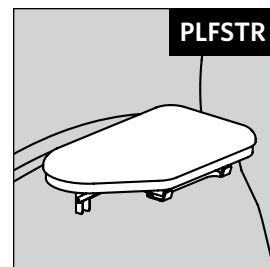

Padded Large Folding Side Tray
Folds out to reveal upholstered surface, standard on right side (facing). Padded to allow patients to comfortable rest arm during treatment. Measures 17" L x 10.7" W. Extends 2.5" from chair arm when in down position.
Left side (facing): PLFSTL
COM requires 1 yd.

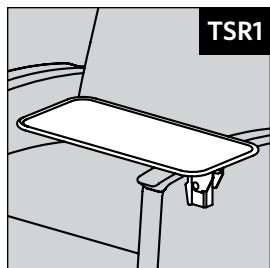

Adjustable Side Tray
Tray swivels at base and can be positioned vertically at side of arm when not in use (extends 4" from arm). Measures 23" L x 10.7" W. Attached to recliner arm via included QR Bracket, standard on right side (facing). Access to handle may be impeded when specified on handle side.
Left side (facing): TSL1
Dual sides: TD3

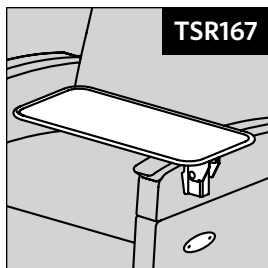

Adjustable Side Tray (On Fold Down Arm)
Same specifications as Adjustable Side Tray (TSR1), attached to fold down transfer arm. Strike plate installed on side of recliner arm to protect upholstery from QR bracket when arm is folded down.
Left side (facing): TSL167
Dual sides: TD362

Additional Features & Options

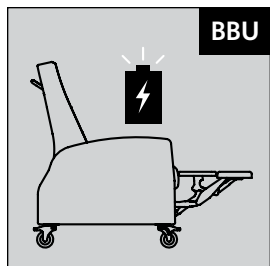

Battery Back Up
Provides back up power supply to allow recliner functions on applicable power recliners when disconnected from power source. Battery unit charges when recliner is connected to power source. Not intended as substitute for regular operational usage.

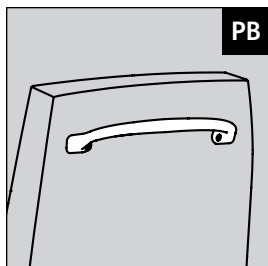

Push Bar
Aids in ease of movement of mobile healthcare recliners. Attached to back of applicable recliners.

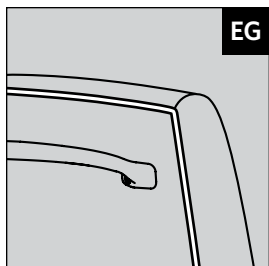

Protective Edge Guard
Plastic piping installed around back edges of recliner to protect from minor abrasions.

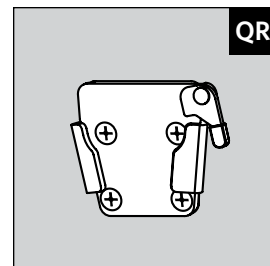

Additional Quick Release Accessory Bracket
Additional attachment bracket for IV Pole and other various accessories. (Options requiring QR Bracket include the necessary bracket/hardware) Mounted into metal insert nuts in recliner arm.

DURABLE® 550 SERIES



Series Overview

The Durable® 550 Series is our collection of Rocker Recliners, all featuring the patented Durable® unitized mechanism, which harmonizes motion of the back, footrest, and seat for smooth, full-body movement. Available in both stationary and mobile configurations, as well as patient transfer options, all models in the Durable® 550 Series boast a full flatbed sleep position and a 550 lb weight capacity to make them an exceptional fit for healthcare applications where comfort is key.

General Product Information

- 550 lb Weight Rating
- Stationary or mobile base allows rocking functionality
- Designed for 24/7 use healthcare environments
- Manually operated recline functionality
- Footrest and back move in harmony when engaged
- Quick removable back & lift up seat for ease of cleaning
- True flatbed sleep position
- Sinuous spring seat and back
- Seat clean-out
- Mid-Ottoman Calf Support
- Infinite Position Back reclines to infinite angle positions
- All interior plywood California Carb Compliant/Phase II
- Field replaceable components

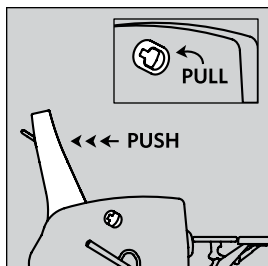

Infinite Position Locking Back

Allows patient/caregiver to lock back into any position. Lock lever located outside left (facing) arm on applicable 550 Series models, unless otherwise noted/pictured.

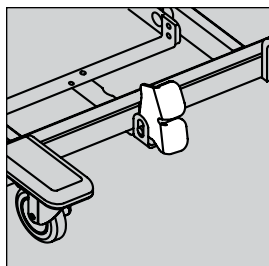

Rocker Lock Mechanism

Mobile Rocker Recliners feature a pedal on rear of base to lock & unlock rocking motion, allowing easier entry or exit of chair by users.

To Order, Specify

- Model Number
- Textile
- Finish
- Options

Options vary by model, see specific model page for list of available options

Refer to pg 107 for full option details and images

DURABLE® 550 SERIES

Healthcare Rocker Recliners | Stationary

Select Aesthetic Style *(Denotes back & arm design)*

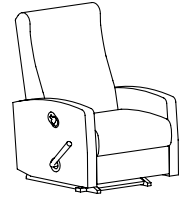
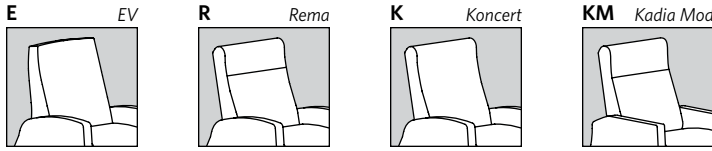

(Koncert style pictured)

Select Functional Style *(Aesthetic style code precedes selected model number below, e.g., RC1127)*

1125 Stationary Rocker Recliner - Infinite Position Locking Back

COM	Dillon	Carson	A ₅	B ₆	C ₇	D ₈	E ₉	F ₁₀	G ₁₁	H ₁₂	I ₁₃
3909	3949	4109	4239	4429	4639	4899	5229	5789	6189	6579	

C1125 Stationary Chaise Rocker Recliner - Infinite Position Locking Back

COM	Dillon	Carson	A ₅	B ₆	C ₇	D ₈	E ₉	F ₁₀	G ₁₁	H ₁₂	I ₁₃
4189	4249	4379	4539	4719	4909	5179	5499	6049	6579	6979	

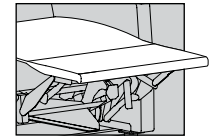

Chaise Models

Dimensions

	Overall			Seat			Back H	Arm H	Kick Out Seat D	Recline D	Distance from Wall
	W	D	H	W	D	H					
E1125 EC1125	32.5	34.25	43.25	23.75	21	18.75	24.5	24.25	36	71	19.5
R1125 RC1125 K1125 KC1125	32.5	39	43.25	23.75	21	18.75	24.5	24.25	36	71	18.5
KM1125 KMC1125	32.5	39	43.25	23.75	21	18.75	24.5	24.5	36	71	16

General Info

COM: 5 yds
w/ Chaise
COM: 6 yds

Wt Cap: 550 lb
Unit
Weight: 134 lb

Available Options

ARM CAP OPTIONS

See pg 2 for finishes

U	Urethane	169
J1	Solid Surface - Group 1	619
J2	Solid Surface - Group 2	819
F	Fully Upholstered Arms	Standard

CASTER OPTIONS

Not applicable on stationary models

ADDITIONAL FEATURES & OPTIONS

EG	Protective Edge Guard	Standard
QR	Additional Quick Release Accessory Bracket	69
CAL	CAL TB133	See pg 9
Z	Multi Cover	Use Pricing for Highest Grade

PATIENT WELLNESS & COMFORT OPTIONS

ABP	Adjustable Back Pad (COM 1.75 yds)	
	Textile Grades COM-B	459
	Textile Grades C-I	569
FBH	Foley Bag Holder	89
MBB	Moisture Barrier (Back)	59
MBS	Moisture Barrier (Seat)	59
MR	Monitor Arm (right side facing) ^{1,2}	849
MTR	Monitor Arm with Tray (right side facing) ^{1,2}	949

Refer to pg 107 for full option details and images

¹Includes QR bracket connection installed on recliner

²Standard on right side (facing). Replace "R" with "L" for left side (facing) option where available.



DURABLE® 550 SERIES

Healthcare Rocker Recliners | Stationary

Select Aesthetic Style (Denotes back & arm design)

E EV-Narrow Arm

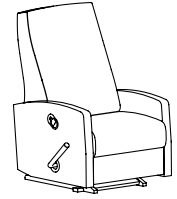
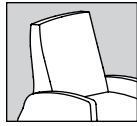

Select Functional Style (Aesthetic style code precedes selected model number below, e.g., RC1127)

4125 Stationary Rocker Recliner - Narrow Arms - Infinite Position Locking Back

COM	Dillon	Carson	A ₅	B ₆	C ₇	D ₈	E ₉	F ₁₀	G ₁₁	H ₁₂	I ₁₃
3909	3949	4109	4239	4429	4639	4899	5229	5789	6179	6579	

C4125 Stationary Rocker Chaise Recliner - Narrow Arms - Infinite Position Locking Back

COM	Dillon	Carson	A ₅	B ₆	C ₇	D ₈	E ₉	F ₁₀	G ₁₁	H ₁₂	I ₁₃
4189	4249	4379	4539	4719	4909	5179	5499	6049	6579	6979	

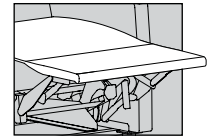

Chaise Models

Dimensions

E4125 EC4125	Overall			Seat			Back H	Arm H	Kick Out Seat D	Recline D	Distance from Wall
	W	D	H	W	D	H					
	32	34.25	43.25	23.75	21	18.75	24.5	24.25	36	72	19.5

General Info

COM: 5 yds
 w/ Chaise COM: 6 yds
 Wt Cap: 550 lb
 Unit Weight: 128 lb

Available Options

ARM CAP OPTIONS

See pg 2 for finishes

U	Urethane	169
J1	Solid Surface - Group 1	619
J2	Solid Surface - Group 2	819
F	Fully Upholstered Arms	Standard

CASTER OPTIONS

Not applicable on stationary models

ADDITIONAL FEATURES & OPTIONS

EG	Protective Edge Guard	Standard
QR	Additional Quick Release Accessory Bracket	69
CAL	CAL TB133	See pg 9
Z	Multi Cover	Use Pricing for Highest Grade

PATIENT WELLNESS & COMFORT OPTIONS

ABP	Adjustable Back Pad (COM 1.75 yds)	
	Textile Grades COM-B	459
	Textile Grades C-I	569
FBH	Foley Bag Holder	89
MBB	Moisture Barrier (Back)	59
MBS	Moisture Barrier (Seat)	59
MR	Monitor Arm (right side facing) ^{1,2}	849
MTR	Monitor Arm with Tray (right side facing) ^{1,2}	949

Refer to pg 107 for full option details and images

¹Includes QR bracket connection installed on recliner

²Standard on right side (facing). Replace "R" with "L" for left side (facing) option where available.

DURABLE® 550 SERIES

Healthcare Rocker Recliners | Stationary

Select Aesthetic Style (Denotes back & arm design)

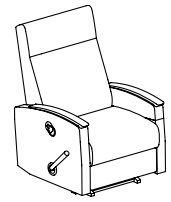
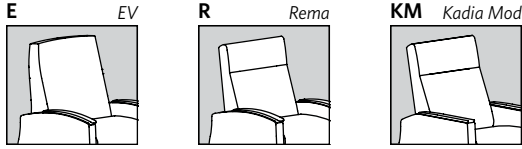

(Rema style pictured)

Select Functional Style (Aesthetic style code precedes selected model number below, e.g., RC1127)

1125R Stationary Rocker Recliner - Infinite Position Locking Back - Right Facing Fold Down Arm

COM	Dillon	Carson	A ₅	B ₆	C ₇	D ₈	E ₉	F ₁₀	G ₁₁	H ₁₂	I ₁₃
4819	4899	4909	5039	5229	5299	5609	5879	6249	6699	7099	

C1125R Stationary Chaise Rocker Recliner - Infinite Position Locking Back - Right Facing Fold Down Arm

COM	Dillon	Carson	A ₅	B ₆	C ₇	D ₈	E ₉	F ₁₀	G ₁₁	H ₁₂	I ₁₃
5139	5279	5319	5399	5629	5789	6039	6359	6689	7099	7499	

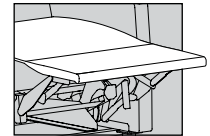

Chaise Models

NOTE: Transfer arm standard on right side (facing). Replace "R" with "L" in model number to specify on left side, handle will be placed on right side and vice versa.

Dimensions

	Overall			Seat			Back H	Arm H	Kick Out Seat D	Recline D	Distance from Wall
	W	D	H	W	D	H					
E1125R EC1125R E1125L EC1125L	32.5	34.25	43.25	23.75	21	18.75	24.5	24.25	36	71	19.5
R1125R RC1125R R1125L RC1125L	32.5	39	43.25	23.75	21	18.75	24.5	24.25	36	71	18.5
KM1125R KMC1125R KM1125L KMC1125L	32.5	39	43.25	23.75	20.5	18.75	24.5	24.5	36	71	18.5

General Info

COM: 5 yds
w/ Chaise
COM: 6 yds
Wt Cap: 550 lb
Unit Weight: 134 lb

Available Options

ARM CAP OPTIONS

See pg 2 for finishes

U	Urethane	Standard
J1	Solid Surface - Group 1	619
J2	Solid Surface - Group 2	819

CASTER OPTIONS

Not applicable on stationary models

ADDITIONAL FEATURES & OPTIONS

EG	Protective Edge Guard	Standard
QR	Additional Quick Release Accessory Bracket	69
CAL	CAL TB133	See pg 9
Z	Multi Cover	Use Pricing for Highest Grade

PATIENT WELLNESS & COMFORT OPTIONS

ABP	Adjustable Back Pad (COM 1.75 yds)	
	Textile Grades COM-B	459
	Textile Grades C-I	569
FBH	Foley Bag Holder	89
MBB	Moisture Barrier (Back)	59
MBS	Moisture Barrier (Seat)	59
ML	Monitor Arm (left side facing) ^{1,2}	849
MTL	Monitor Arm with Tray (left side facing) ^{1,2}	949

Refer to pg 107 for full option details and images

¹Includes QR bracket connection installed on recliner

²Standard on left side (facing). Replace "L" with "R" for right side (facing) option when specifying left side fold down arm.

DURABLE® 550 SERIES

Healthcare Rocker Recliners | Mobile

Select Aesthetic Style *(Denotes back & arm design)*

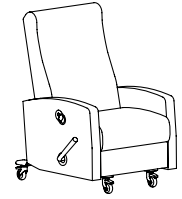
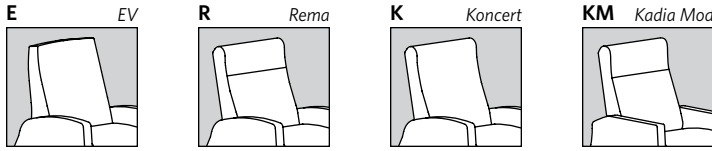

(Koncert style pictured)

Select Functional Style *(Aesthetic style code precedes selected model number below, e.g., RC1127)*

1127 Mobile Rocker Recliner - Infinite Position Locking Back

COM	Dillon/Carson	A ₅	B ₆	C ₇	D ₈	E ₉	F ₁₀	G ₁₁	H ₁₂	I ₁₃
4269	4349	4489	4649	4919	5159	5469	5829	6539	6969	7369

C1127 Mobile Chaise Rocker Recliner - Infinite Position Locking Back

COM	Dillon/Carson	A ₅	B ₆	C ₇	D ₈	E ₉	F ₁₀	G ₁₁	H ₁₂	I ₁₃
4559	4639	4779	4929	5229	5429	5759	6099	6799	7239	7629

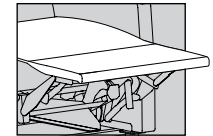

Chaise Models

Dimensions

	Overall			Seat			Back H	Arm H	Kick Out Seat D	Recline D	Distance from Wall
	W	D	H	W	D	H					
E1127 EC1127	32.5	38	44	23.75	21.5	19.75	24.5	25	37.5	72.5	20
R1127 RC1127 K1127 KC1127	32.5	38	44	23.75	21.5	19.75	24.5	25	37.5	72.5	20
KM1127 KMC1127	32.5	38	44	23.75	20.5	19.75	24.5	25.25	37.5	72.5	20

General Info

COM: 6 yds
w/ Chaise
COM: 7 yds
Wt Cap: 550 lb
Unit Weight: 156 lb

Available Options

ARM CAP OPTIONS

See pg 2 for finishes

U	Urethane	169
J1	Solid Surface - Group 1	619
J2	Solid Surface - Group 2	819
F	Fully Upholstered Arms	Standard

CASTER OPTIONS

3S1R3	3" - (3) Swivel/(1) Rigid Locking Casters	Standard
3S4	3" - (4) Swivel Locking Casters	19

ADDITIONAL FEATURES & OPTIONS

PB	Push Bar	Standard
EG	Protective Edge Guard	Standard
QR	Additional Quick Release Accessory Bracket	69
CAL	CAL TB133	See pg 9
Z	Multi Cover	Use Pricing for Highest Grade

PATIENT WELLNESS & COMFORT OPTIONS

ABP	Adjustable Back Pad (COM 1.75 yds)	
	Textile Grades COM-B	459
	Textile Grades C-I	569
AHP	Adjustable Head Rest Pillow (COM 1 yd)	339
FBH	Foley Bag Holder	89
MBB	Moisture Barrier (Back)	59
MBS	Moisture Barrier (Seat)	59
MR	Monitor Arm (right side facing) ^{1,2}	849
MTR	Monitor Arm with Tray (right side facing) ^{1,2}	949

Refer to pg 107 for full option details and images

¹Includes QR bracket connection installed on recliner

²Standard on right side (facing). Replace "R" with "L" for left side (facing) option where available.

Select Aesthetic Style (Denotes back & arm design)

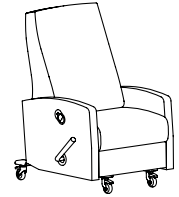
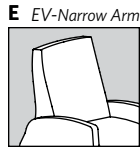

Select Functional Style (Aesthetic style code precedes selected model number below, e.g., RC1127)

4127 Mobile Rocker Recliner - Narrow Arms - Infinite Position Locking Back

COM	Dillon	Carson	A ₅	B ₆	C ₇	D ₈	E ₉	F ₁₀	G ₁₁	H ₁₂	I ₁₃
4269	4349	4489	4649	4919	5159	5469	5829	6539	6969	7369	

C4127 Mobile Rocker Chaise Recliner - Narrow Arms - Infinite Position Locking Back

COM	Dillon	Carson	A ₅	B ₆	C ₇	D ₈	E ₉	F ₁₀	G ₁₁	H ₁₂	I ₁₃
4559	4639	4779	4929	5229	5429	5759	6099	6799	7239	7629	

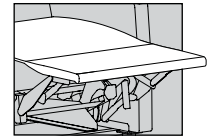

Chaise Models

Dimensions

	Overall			Seat			Back H	Arm H	Kick Out Seat D	Recline D	Distance from Wall
	W	D	H	W	D	H					
E4127 EC4127	32	38	44	23.75	21.5	19.75	24.5	25	37.5	72.5	20

General Info

COM: 6 yds
w/ Chaise COM: 7 yds
Wt Cap: 550 lb
Unit Weight: 151 lb

Available Options

ARM CAP OPTIONS

See pg 2 for finishes

U	Urethane	169
J1	Solid Surface - Group 1	619
J2	Solid Surface - Group 2	819
F	Fully Upholstered Arms	Standard

CASTER OPTIONS

3S1R3	3" - (3) Swivel/(1) Rigid Locking Casters	Standard
3S4	3" - (4) Swivel Locking Casters	19

ADDITIONAL FEATURES & OPTIONS

PB	Push Bar	Standard
EG	Protective Edge Guard	Standard
QR	Additional Quick Release Accessory Bracket	69
CAL	CAL TB133	See pg 9
Z	Multi Cover	Use Pricing for Highest Grade

PATIENT WELLNESS & COMFORT OPTIONS

ABP	Adjustable Back Pad (COM 1.75 yds)	
	Textile Grades COM-B	459
	Textile Grades C-I	569
AHP	Adjustable Head Rest Pillow (COM 1 yd)	339
FBH	Foley Bag Holder	89
MBB	Moisture Barrier (Back)	59
MBS	Moisture Barrier (Seat)	59
MR	Monitor Arm (right side facing) ^{1,2}	849
MTR	Monitor Arm with Tray (right side facing) ^{1,2}	949

Refer to pg 107 for full option details and images

¹Includes QR bracket connection installed on recliner

²Standard on right side (facing). Replace "R" with "L" for left side (facing) option where available.

DURABLE® 550 SERIES

Healthcare Rocker Recliners | Mobile

Select Aesthetic Style (Denotes back & arm design)

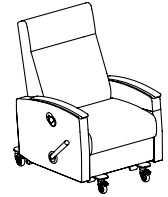
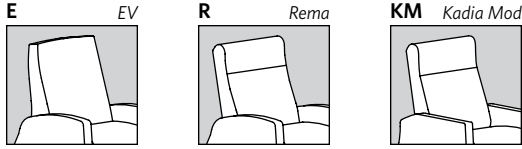

(Rema style pictured)

Select Functional Style (Aesthetic style code precedes selected model number below, e.g., RC1127)

1127R Mobile Rocker Recliner - Infinite Position Locking Back - Right Facing Fold Down Arm

COM	Dillon/Carson	A ₅	B ₆	C ₇	D ₈	E ₉	F ₁₀	G ₁₁	H ₁₂	I ₁₃
5079	5139	5159	5289	5469	5549	5849	6109	6479	7199	7629

C1127R Mobile Chaise Rocker Recliner - Infinite Position Locking Back - Right Facing Fold Down Arm

COM	Dillon/Carson	A ₅	B ₆	C ₇	D ₈	E ₉	F ₁₀	G ₁₁	H ₁₂	I ₁₃
5399	5539	5579	5649	5869	6029	6279	6589	6929	7499	7899

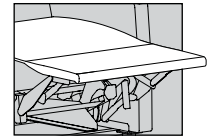

Chaise Models

NOTE: Transfer arm standard on right side (facing). Replace "R" with "L" in model number to specify on left side, handle will be placed on right side and vice versa.

Dimensions

	Overall			Seat			Back H	Arm H	Kick Out Seat D	Recline D	Distance from Wall
	W	D	H	W	D	H					
E1127R EC1127R E1127L EC1127L	32.5	38	44	23.75	21.5	19.75	24.5	25	37.5	72.5	20
R1127R RC1127R R1127L RC1127L	32.5	38	44	23.75	21.5	19.75	24.5	25	37.5	72.5	20
KM1127R KMC1127R KM1127L KMC1127L	32.5	38	44	23.75	21.5	19.75	24.5	25.25	37.5	72.5	20

General Info	
COM:	6 yds
w/ Chaise COM:	7 yds
Wt Cap:	550 lb
Unit Weight:	156 lb

Available Options

ARM CAP OPTIONS

See pg 2 for finishes

U	Urethane	Standard
J1	Solid Surface - Group 1	619
J2	Solid Surface - Group 2	819

CASTER OPTIONS

3S1R3	3" - (3) Swivel/(1) Rigid Locking Casters	Standard
3S4	3" - (4) Swivel Locking Casters	19

ADDITIONAL FEATURES & OPTIONS

PB	Push Bar	Standard
EG	Protective Edge Guard	Standard
QR	Additional Quick Release Accessory Bracket	69
CAL	CAL TB133	See pg 9
Z	Multi Cover	Use Pricing for Highest Grade

PATIENT WELLNESS & COMFORT OPTIONS

ABP	Adjustable Back Pad (COM 1.75 yds)	
	Textile Grades COM-B	459
	Textile Grades C-I	569
AHP	Adjustable Head Rest Pillow (COM 1 yd)	339
FBH	Foley Bag Holder	89
MBB	Moisture Barrier (Back)	59
MBS	Moisture Barrier (Seat)	59
ML	Monitor Arm (left side facing) ^{1,2}	849
MTL	Monitor Arm with Tray (left side facing) ^{1,2}	949

Refer to pg 107 for full option details and images

¹Includes QR bracket connection installed on recliner

²Standard on left side (facing). Replace "L" with "R" for right side (facing) option when specifying left side fold down arm.



DURABLE® 650 SERIES



Series Overview

The Durable® 650 Series is our premier collection of mobile healthcare recliners. Featuring a patented unitized mechanism (which harmonizes motion of the back, foot rest, and seat for smooth, full-body movement), 650 lb weight capacity, full flatbed sleep position, and near limitless option configurations to adapt to any environment, the Durable® 650 Series truly encapsulates our core product values of Comfort, Durability, and Performance to make it a recliner choice trusted by patients and caregivers alike.

General Product Information

- 650 lb Weight Rating
- Designed for 24/7 use healthcare environments
- Standard & compact/pediatric width options
- Manually operated recline functionality
- Footrest and back move in harmony when engaged
- Quick removable back & lift up seat for ease of cleaning
- True flatbed sleep position
- Sinuous spring seat and back
- Seat clean-out
- Mid-Ottoman Calf Support
- Infinite Position Back reclines to infinite angle positions
- All interior plywood California Carb Compliant/Phase II
- Field replaceable components

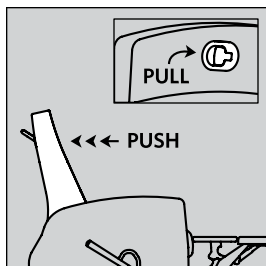

Infinite Position Locking Back

Allows patient/caregiver to lock back into any position. Lock lever located inside left (facing) arm on applicable models, unless otherwise noted/pictured.

To Order, Specify

- Model Number
- Textile
- Finish
- Options

Options vary by model, see specific model page for list of available options

Refer to pg 107 for full option details and images

DURABLE® 650 SERIES

Mobile Healthcare Recliners | Compact

Select Aesthetic Style *(Denotes back & arm design)*

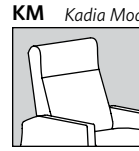
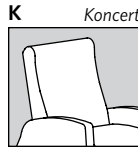
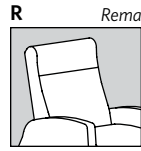
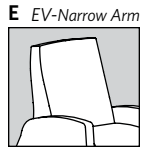

(Koncert style pictured)

Select Functional Style *(Aesthetic style code precedes selected model number below, e.g., KC1117)*

3017 Compact Mobile Healthcare Recliner - Infinite Position Non-Locking Back

COM	<i>Dillon/Carson</i>	A ₅	B ₆	C ₇	D ₈	E ₉	F ₁₀	G ₁₁	H ₁₂	I ₁₃
3889	3939	4079	4279	4519	4759	5049	5409	6869	7369	7899

3117 Compact Mobile Healthcare Recliner - Infinite Position Locking Back

COM	<i>Dillon/Carson</i>	A ₅	B ₆	C ₇	D ₈	E ₉	F ₁₀	G ₁₁	H ₁₂	I ₁₃
4149	4269	4369	4569	4839	5059	5379	5479	6969	7499	8159

C3017 Compact Mobile Healthcare Chaise Recliner - Infinite Position Non-Locking Back

COM	<i>Dillon/Carson</i>	A ₅	B ₆	C ₇	D ₈	E ₉	F ₁₀	G ₁₁	H ₁₂	I ₁₃
4129	4249	4409	4679	4999	5299	5699	6169	7759	8299	8819

C3117 Compact Mobile Healthcare Chaise Recliner - Infinite Position Locking Back

COM	<i>Dillon/Carson</i>	A ₅	B ₆	C ₇	D ₈	E ₉	F ₁₀	G ₁₁	H ₁₂	I ₁₃
4399	4539	4689	4969	5309	5609	6019	6239	7829	8419	8949

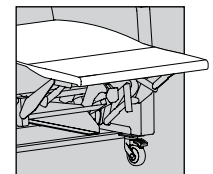

Chaise Models

Dimensions

	Overall			Seat			Back H	Arm H	Kick Out Seat D	Recline D	Distance from Wall
	W	D	H	W	D	H					
E3017 E3117 EC3017 EC3117	30.5	34.5	47.5	22	21	21.5	28.5	28	40	75.5	20
R3017 R3117 RC3017 RC3117 K3017 K3117 KC3017 KC3117	31.5	38.5	47	22	21	21.5	28	28	40	76.5	20
KM3017 KM3117 KMC3017 KMC3117	31.5	38.5	47	22	21	21.5	28	26.5	39	76.5	20

General Info	
COM:	5.5 yds
w/ Chaise COM:	6.5 yds
Wt Cap:	650 lb
Unit Weight:	155 lb

Available Options

ARM CAP OPTIONS		See pg 2 for finishes	PATIENT WELLNESS & COMFORT OPTIONS	
U	Urethane	169	ABP	Adjustable Back Pad (COM 1.75 yds)
J1	Solid Surface - Group 1	619		Textile Grades COM-B 459
J2	Solid Surface - Group 2	819		Textile Grades C-I 569
F	Fully Upholstered Arms	Standard	AHP	Adjustable Head Rest Pillow (COM 1 yd) 339
CASTER OPTIONS			DP	Dual IV Poles & Brackets ¹ 498
Q3	3" - Dual Wheel Central Locking System	1019	FBH	Foley Bag Holder 89
Q4	4" - Central Lock & Steer System	1019	FT	Foot Tray 279
Q5	5" - Central Lock & Steer System	1139	IV	IV Pole & Bracket ¹ 249
S4	4" - (2) Caster Lock & Steer System	569	LC	LiquiCell 229
4S3R1	4" - (3) Swivel/(1) Rigid Locking Casters	Standard	LCKFR	Orthopedic Locking Footrest 399
4S4	4" - (4) Swivel Locking Casters	39	MBB	Moisture Barrier (Back) 59
HEAT/MASSAGE OPTIONS (IEC 60601-1 CERTIFIED)			MBS	Moisture Barrier (Seat) 59
<i>Wand Controls</i>			MR	Monitor Arm (right side facing) ^{1,2} 849
HW	Heat	1139	MTR	Monitor Arm with Tray (right side facing) ^{1,2} 949
HMW	Heat & Massage	1369	PR1	Paper Roll Holder ³ 229
<i>In-Arm Controls</i>			TE	Trendelenburg 339
H	Heat	849	USB	USB Power Outlet (IEC 60601-1 Certified) 459
HM	Heat & Massage	1119	WR	Wrist Restraint Mounts (pair) 229
ADDITIONAL FEATURES & OPTIONS			TRAY TABLE OPTIONS	
PB	Push Bar	Standard	TSR1	Adjustable (Right) Side Tray ^{1,2,5} 399
EG	Protective Edge Guard	Standard	TD3	Dual Adjustable Side Trays (TSR1 & TSL1) ^{1,5} 798
QR	Additional Quick Release Accessory Bracket	69	LFSTR	Large Folding (Right) Side Tray ⁴ 249
CAL	CAL TB133	See pg 9	LFSTRCH	Large Folding Cup Holder (Right) Side Tray 319
Z	Multi Cover	Use Pricing for Highest Grade	PLFSTR	Padded Large Folding (Right) Side Tray 379
			SFSTR	Small Folding (Right) Side Tray ⁴ 249

Refer to pg 107 for full option details and images

¹Includes QR bracket connection installed on recliner
²Standard on right side (facing). Replace "R" with "L" for left side (facing) option where available.
³Takes place of Push Bar. Paper sold separately.

⁴Contact customer service for solid surface pricing
⁵Over the lap tray function recommended in seated position.



Select Aesthetic Style (Denotes back & arm design)

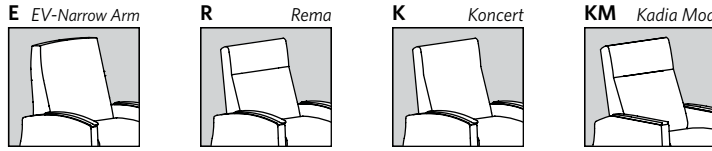

Single Fold Down Arm
(Koncert style pictured)

Select Functional Style (Aesthetic style code precedes selected model number below, e.g., KC1117)

3067	Compact Mobile Healthcare Recliner - Infinite Position Non-Locking Back - Single Fold Down Arm										
COM	Dillon/Carson	A ₅	B ₆	C ₇	D ₈	E ₉	F ₁₀	G ₁₁	H ₁₂	I ₁₃	
4689	4749	4849	5029	5289	5489	5769	6119	7509	7999	8549	
3167	Compact Mobile Healthcare Recliner - Infinite Position Locking Back - Single Fold Down Arm										
COM	Dillon/Carson	A ₅	B ₆	C ₇	D ₈	E ₉	F ₁₀	G ₁₁	H ₁₂	I ₁₃	
4979	5039	5109	5319	5569	5789	6089	6199	7579	8159	8689	
C3067	Compact Mobile Healthcare Chaise Recliner - Infinite Position Non-Locking Back - Single Fold Down Arm										
COM	Dillon/Carson	A ₅	B ₆	C ₇	D ₈	E ₉	F ₁₀	G ₁₁	H ₁₂	I ₁₃	
4879	4999	5119	5369	5709	5969	6329	6789	8469	8819	9349	
C3167	Compact Mobile Healthcare Chaise Recliner - Infinite Position Locking Back - Single Fold Down Arm										
COM	Dillon/Carson	A ₅	B ₆	C ₇	D ₈	E ₉	F ₁₀	G ₁₁	H ₁₂	I ₁₃	
5169	5269	5409	5669	5999	6279	6679	6859	8539	9079	9599	

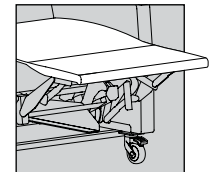

Chaise Models

NOTE: Transfer arm standard on right side (facing). If specified on left side, handle will be placed on right side and vice versa.

Dimensions

	Overall			Seat			Back H	Arm H	Kick Out Seat D	Recline D	Distance from Wall
	W	D	H	W	D	H					
E3067 E3167 EC3067 EC3167	30.5	34.5	47.5	22	21	21.5	28.5	27	39	75.5	20
R3067 R3167 RC3067 RC3167	31.5	38.5	47	22	21	21.5	28	27	40	76.5	20
K3067 K3167 KC3067 KC3167	31.5	38.5	47	22	21	21.5	28	26.5	40	76.5	20
KM3067 KM3167 KMC3067 KMC3167	31.5	38.5	47	22	21	21.5	28	26.5	40	76.5	20

General Info

COM: 7 yds
w/ Chaise COM: 8 yds
Wt Cap: 650 lb
Unit Weight: 155 lb

Available Options

ARM CAP OPTIONS	See pg 2 for finishes	PATIENT WELLNESS & COMFORT OPTIONS	
U Urethane	Standard	ABP Adjustable Back Pad (COM 1.75 yds)	
J1 Solid Surface - Group 1	619	Textile Grades COM-B 459	
J2 Solid Surface - Group 2	819	Textile Grades C-I 569	
CASTER OPTIONS		AHP Adjustable Head Rest Pillow (COM 1 yd) 339	
Q3 3" - Dual Wheel Central Locking System	1019	DP Dual IV Poles & Brackets ¹ 498	
Q4 4" - Central Lock & Steer System	1019	FBH Foley Bag Holder 89	
Q5 5" - Central Lock & Steer System	1139	FT Foot Tray 279	
S4 4" - (2) Caster Lock & Steer System	569	IV IV Pole & Bracket ¹ 249	
4S3R1 4" - (3) Swivel/(1) Rigid Locking Casters	Standard	LC LiquiCell 229	
4S4 4" - (4) Swivel Locking Casters	39	LCKFR Orthopedic Locking Footrest 399	
HEAT/MASSAGE OPTIONS (IEC 60601-1 CERTIFIED)		MBB Moisture Barrier (Back) 59	
<i>Wand Controls</i>		MBS Moisture Barrier (Seat) 59	
HW Heat	1139	MR Monitor Arm (right side facing) ^{1,2} 849	
HMW Heat & Massage	1369	MTR Monitor Arm with Tray (right side facing) ^{1,2} 949	
<i>In-Arm Controls</i>		PR1 Paper Roll Holder ³ 229	
H Heat	849	TE Trendelenburg 339	
HM Heat & Massage	1119	USB USB Power Outlet (IEC 60601-1 Certified) 459	
ADDITIONAL FEATURES & OPTIONS		WR Wrist Restraint Mounts (pair) 229	
PB Push Bar	Standard	TRAY TABLE OPTIONS	
EG Protective Edge Guard	Standard	TSL1 Adjustable (Left) Side Tray, on Stationary Arm ¹⁵	399
QR Additional Quick Release Accessory Bracket	69	TSR167 Adjustable (Right) Side Tray, on Fold Down Arm ¹⁵	449
CAL CAL TB133	See pg 9	FOLD DOWN TRANSFER ARM SPECIFIC	
Z Multi Cover	Use Pricing for Highest Grade	HC Hinge Cover	Standard

Refer to pg 107 for full option details and images

¹Includes QR bracket connection installed on recliner
²Standard on right side (facing). Replace "R" with "L" for left side (facing) option where available.
³Takes place of Push Bar. Paper sold separately.

⁴Contact customer service for solid surface pricing
⁵Over the lap tray function recommended in seated position.



DURABLE® 650 SERIES

Mobile Healthcare Recliners | Compact, Patient Transfer

Select Aesthetic Style (Denotes back & arm design)

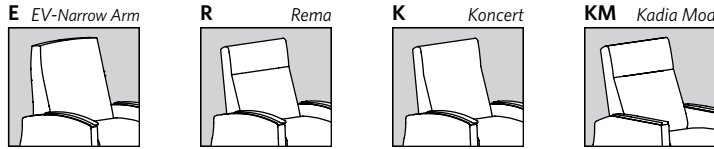

Select Functional Style (Aesthetic style code precedes selected model number below, e.g., KC117)

3062	Compact Mobile Healthcare Recliner - Infinite Position Non-Locking Back - Dual Fold Down Arms										
COM	Dillon/Carson	A ₅	B ₆	C ₇	D ₈	E ₉	F ₁₀	G ₁₁	H ₁₂	I ₁₃	
5359	5419	5499	5689	5939	6129	6409	6739	8119	8689	9159	
3162	Compact Mobile Healthcare Recliner - Infinite Position Locking Back - Dual Fold Down Arms										
COM	Dillon/Carson	A ₅	B ₆	C ₇	D ₈	E ₉	F ₁₀	G ₁₁	H ₁₂	I ₁₃	
6039	6059	6149	6309	6579	6749	7029	7369	8699	9199	9739	
C3062	Compact Mobile Healthcare Chaise Recliner - Infinite Position Non-Locking Back - Dual Fold Down Arms										
COM	Dillon/Carson	A ₅	B ₆	C ₇	D ₈	E ₉	F ₁₀	G ₁₁	H ₁₂	I ₁₃	
5559	5649	5789	6019	6349	6599	6979	7429	8909	9199	9739	
C3162	Compact Mobile Healthcare Chaise Recliner - Infinite Position Locking Back - Dual Fold Down Arms										
COM	Dillon/Carson	A ₅	B ₆	C ₇	D ₈	E ₉	F ₁₀	G ₁₁	H ₁₂	I ₁₃	
6249	6309	6449	6679	6999	7239	7599	8049	9659	10129	10659	

Dual Fold Down Arms
(Konkert style pictured)

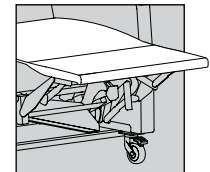

Chaise Models



Locking Back Lever
(located on outside arm on applicable models)

Dimensions

	Overall			Seat			Back H	Arm H	Kick Out Seat D	Recline D	Distance from Wall
	W	D	H	W	D	H					
E3062 E3162 EC3062 EC3162	30.5	34.5	47.5	22	21	21.5	28.5	27	39	75.5	20
R3062 R3162 RC3062 RC3162	31.5	38.5	47	22	21	21.5	28	27	40	76.5	20
K3062 K3162 KC3062 KC3162	31.5	38.5	47	22	21	21.5	28	26.5	40	76.5	20
KM3062 KM3162 KMC3062 KMC3162	31.5	38.5	47	22	21	21.5	28	26.5	40	76.5	20

General Info

COM: 7 yds
w/ Chaise COM: 8 yds
Wt Cap: 650 lb
Unit Weight: 155 lb

Available Options

ARM CAP OPTIONS	See pg 2 for finishes	PATIENT WELLNESS & COMFORT OPTIONS
U Urethane	Standard	ABP Adjustable Back Pad (COM 1.75 yds)
J1 Solid Surface - Group 1	619	Textile Grades COM-B
J2 Solid Surface - Group 2	819	Textile Grades C-I
		AHP Adjustable Head Rest Pillow (COM 1 yd)
		DP Dual IV Poles & Brackets ¹
		FBH Foley Bag Holder
		FT Foot Tray
		IV IV Pole & Bracket ¹
		LC LiquiCell
		LCKFR Orthopedic Locking Footrest
		MBB Moisture Barrier (Back)
		MBS Moisture Barrier (Seat)
		MR Monitor Arm (right side facing) ^{1,2}
		MTR Monitor Arm with Tray (right side facing) ^{1,2}
		PR1 Paper Roll Holder ³
		TE Trendelenburg
		USB USB Power Outlet (IEC 60601-1 Certified)
		WR Wrist Restraint Mounts (pair)
		TRAY TABLE OPTIONS
		TD362 Dual Adjustable Side Trays, on Fold Down Arms ^{1,5}
		TSR167 Adjustable (Right) Side Tray, on Fold Down Arm ^{1,5}
		TSL167 Adjustable (Left) Side Tray, on Fold Down Arm ^{1,5}
		FOLD DOWN TRANSFER ARM SPECIFIC
		HC Hinge Cover
		Standard

¹Includes QR bracket connection installed on recliner
²Standard on right side (facing). Replace "R" with "L" for left side (facing) option where available.
³Takes place of Push Bar. Paper sold separately.

⁴Contact customer service for solid surface pricing
⁵Over the lap tray function recommended in seated position.



DURABLE® 650 SERIES

Mobile Healthcare Recliners

Select Aesthetic Style (Denotes back & arm design)

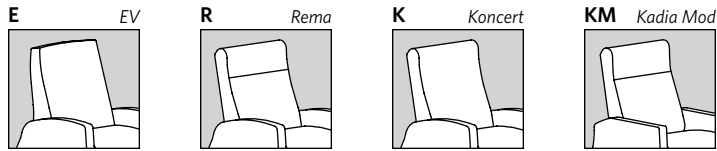

(Koncert style pictured)

Select Functional Style (Aesthetic style code precedes selected model number below, e.g., KC1117)

1017 Mobile Healthcare Recliner - Infinite Position Non-Locking Back

COM	Dillon/Carson	A ₅	B ₆	C ₇	D ₈	E ₉	F ₁₀	G ₁₁	H ₁₂	I ₁₃
3929	4019	4149	4339	4579	4799	5099	5459	7079	7369	7899

1117 Mobile Healthcare Recliner - Infinite Position Locking Back

COM	Dillon/Carson	A ₅	B ₆	C ₇	D ₈	E ₉	F ₁₀	G ₁₁	H ₁₂	I ₁₃
4209	4319	4409	4609	4879	5109	5429	5769	7399	7759	8159

C1017 Mobile Healthcare Chaise Recliner - Infinite Position Non-Locking Back

COM	Dillon/Carson	A ₅	B ₆	C ₇	D ₈	E ₉	F ₁₀	G ₁₁	H ₁₂	I ₁₃
4169	4299	4459	4739	5049	5359	5739	6219	7969	8419	8949

C1117 Mobile Healthcare Chaise Recliner - Infinite Position Locking Back

COM	Dillon/Carson	A ₅	B ₆	C ₇	D ₈	E ₉	F ₁₀	G ₁₁	H ₁₂	I ₁₃
4459	4599	4749	5019	5359	5659	6069	6519	8289	8819	9339

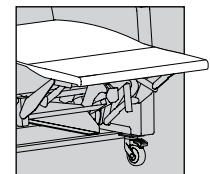

Chaise Models

Dimensions

	Overall			Seat			Back H	Arm H	Kick Out Seat D	Recline D	Distance from Wall
	W	D	H	W	D	H					
E1017 E1117 EC1017 EC1117	33.5	34.5	47.5	24	21	21.5	28.5	28	40	75.5	20
R1017 R1117 RC1017 RC1117 K1017 K1117 KC1017 KC1117	33.5	38.5	47	24	21	21.5	28	28	40	76.5	20
KM1017 KM1117 KMC1017 KMC1117	33.5	38.5	47	24	21	21.5	28	26.5	40	76.5	20

General Info

COM: 6 yds
w/ Chaise COM: 7 yds
Wt Cap: 650 lb
Unit Weight: 166 lb

Available Options

ARM CAP OPTIONS		See pg 2 for finishes	PATIENT WELLNESS & COMFORT OPTIONS	
U	Urethane	169	ABP	Adjustable Back Pad (COM 1.75 yds) Textile Grades COM-B 459 Textile Grades C-I 569
J1	Solid Surface - Group 1	619	AHP	Adjustable Head Rest Pillow (COM 1 yd) 339
J2	Solid Surface - Group 2	819	DP	Dual IV Poles & Brackets ¹ 498
F	Fully Upholstered Arms	Standard	FBH	Foley Bag Holder 89
CASTER OPTIONS			FT	Foot Tray 279
Q3	3" - Dual Wheel Central Locking System	1019	IV	IV Pole & Bracket ¹ 249
Q4	4" - Central Lock & Steer System	1019	LC	LiquiCell 229
Q5	5" - Central Lock & Steer System	1139	LCKFR	Orthopedic Locking Footrest 399
S4	4" - (2) Caster Lock & Steer System	569	MBB	Moisture Barrier (Back) 59
4S3R1	4" - (3) Swivel/(1) Rigid Locking Casters	Standard	MBS	Moisture Barrier (Seat) 59
4S4	4" - (4) Swivel Locking Casters	39	MR	Monitor Arm (right side facing) ^{1,2} 849
HEAT/MASSAGE OPTIONS (IEC 60601-1 CERTIFIED)			MTR	Monitor Arm with Tray (right side facing) ^{1,2} 949
<i>Wand Controls</i>			PR1	Paper Roll Holder ³ 229
HW	Heat	1139	TE	Trendelenburg 339
HMW	Heat & Massage	1369	USB	USB Power Outlet (IEC 60601-1 Certified) 459
<i>In-Arm Controls</i>			WR	Wrist Restraint Mounts (pair) 229
H	Heat	849	TRAY TABLE OPTIONS	
HM	Heat & Massage	1119	TSR1	Adjustable (Right) Side Tray ^{1,2,5} 399
ADDITIONAL FEATURES & OPTIONS			TD3	Dual Adjustable Side Trays (TSR1 & TSL1) ^{1,5} 798
PB	Push Bar	Standard	LFSTR	Large Folding (Right) Side Tray ⁴ 249
EG	Protective Edge Guard	Standard	LFSTRCH	Large Folding Cup Holder (Right) Side Tray 319
QR	Additional Quick Release Accessory Bracket	69	PLFSTR	Padded Large Folding (Right) Side Tray 379
CAL	CAL TB133	See pg 9	SFSTR	Small Folding (Right) Side Tray ⁴ 249
Z	Multi Cover	Use Pricing for Highest Grade	*Refer to pg 107 for full option details and images*	

¹Includes QR bracket connection installed on recliner

²Standard on right side (facing). Replace "R" with "L" for left side (facing) option where available.

³Takes place of Push Bar. Paper sold separately.

⁴Contact customer service for solid surface pricing

⁵Over the lap tray function recommended in seated position.



DURABLE® 650 SERIES

Mobile Healthcare Recliners

Select Aesthetic Style (Denotes back & arm design)

E EV-Narrow Arm

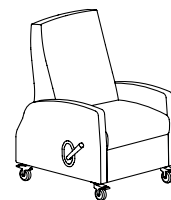
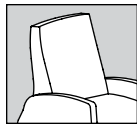

Select Functional Style (Aesthetic style code precedes selected model number below, e.g., KC1117)

4017 Mobile Healthcare Recliner - Narrow Arms - Infinite Position Non-Locking Back

COM	Dillon/Carson	A ₅	B ₆	C ₇	D ₈	E ₉	F ₁₀	G ₁₁	H ₁₂	I ₁₃
3889	3939	4079	4279	4519	4759	5049	5409	6869	7369	7899

4117 Mobile Healthcare Recliner - Narrow Arms - Infinite Position Locking Back

COM	Dillon/Carson	A ₅	B ₆	C ₇	D ₈	E ₉	F ₁₀	G ₁₁	H ₁₂	I ₁₃
4149	4269	4369	4569	4839	5059	5379	5479	6969	7499	8159

C4017 Mobile Healthcare Chaise Recliner - Narrow Arms - Infinite Position Non-Locking Back

COM	Dillon/Carson	A ₅	B ₆	C ₇	D ₈	E ₉	F ₁₀	G ₁₁	H ₁₂	I ₁₃
4129	4249	4409	4679	4999	5299	5699	6169	7759	8299	8819

C4117 Mobile Healthcare Chaise Recliner - Narrow Arms - Infinite Position Locking Back

COM	Dillon/Carson	A ₅	B ₆	C ₇	D ₈	E ₉	F ₁₀	G ₁₁	H ₁₂	I ₁₃
4399	4539	4689	4969	5309	5609	6019	6239	7829	8419	8949

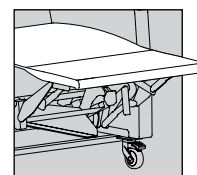

Chaise Models

Dimensions

E4017 E4117 EC4017 EC4117	Overall			Seat			Back H	Arm H	Kick Out Seat D	Recline D	Distance from Wall
	W	D	H	W	D	H					
	32.5	34.5	47.5	24	21	21.5	28.5	28	40	75.5	20

General Info

COM:	5.5 yds
w/ Chaise COM:	6.5 yds
Wt Cap:	650 lb
Unit Weight:	155 lb

Available Options

ARM CAP OPTIONS

See pg 2 for finishes

U	Urethane	169
J1	Solid Surface - Group 1	619
J2	Solid Surface - Group 2	819
F	Fully Upholstered Arms	Standard

CASTER OPTIONS

Q3	3" - Dual Wheel Central Locking System	1019
Q4	4" - Central Lock & Steer System	1019
Q5	5" - Central Lock & Steer System	1139
S4	4" - (2) Caster Lock & Steer System	569
4S3R1	4" - (3) Swivel/(1) Rigid Locking Casters	Standard
4S4	4" - (4) Swivel Locking Casters	39

HEAT/MASSAGE OPTIONS (IEC 60601-1 CERTIFIED)

Wand Controls

HW	Heat	1139
HMW	Heat & Massage	1369

In-Arm Controls

H	Heat	849
HM	Heat & Massage	1119

ADDITIONAL FEATURES & OPTIONS

PB	Push Bar	Standard
EG	Protective Edge Guard	Standard
QR	Additional Quick Release Accessory Bracket	69
CAL	CAL TB133	See pg 9
Z	Multi Cover	Use Pricing for Highest Grade

PATIENT WELLNESS & COMFORT OPTIONS

ABP	Adjustable Back Pad (COM 1.75 yds)	
	Textile Grades COM-B	459
	Textile Grades C-I	569
AHP	Adjustable Head Rest Pillow (COM 1 yd)	339
DP	Dual IV Poles & Brackets ¹	498
FBH	Foley Bag Holder	89
FT	Foot Tray	279
IV	IV Pole & Bracket ¹	249
LC	LiquiCell	229
LCKFR	Orthopedic Locking Footrest	399
MBB	Moisture Barrier (Back)	59
MBS	Moisture Barrier (Seat)	59
MR	Monitor Arm (right side facing) ^{1,2}	849
MTR	Monitor Arm with Tray (right side facing) ^{1,2}	949
PR1	Paper Roll Holder ³	229
TE	Trendelenburg	339
USB	USB Power Outlet (IEC 60601-1 Certified)	459
WR	Wrist Restraint Mounts (pair)	229

TRAY TABLE OPTIONS

TSR1	Adjustable (Right) Side Tray ^{1,2,5}	399
TD3	Dual Adjustable Side Trays (TSR1 & TSL1) ^{1,5}	798
LFSTR	Large Folding (Right) Side Tray ⁴	249
LFSTRCH	Large Folding Cup Holder (Right) Side Tray	319
PLFSTR	Padded Large Folding (Right) Side Tray	379
SFSTR	Small Folding (Right) Side Tray ⁴	249

Refer to pg 107 for full option details and images

¹Includes QR bracket connection installed on recliner

²Standard on right side (facing). Replace "R" with "L" for left side (facing) option where available.

³Takes place of Push Bar. Paper sold separately.

⁴Contact customer service for solid surface pricing

⁵Over the lap tray function recommended in seated position.



DURABLE® 650 SERIES

Mobile Healthcare Recliners | Kadia Luxe

Select Aesthetic Style (Denotes back & arm design)

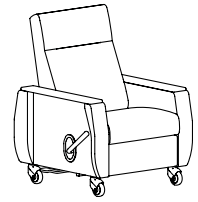
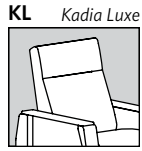

Select Functional Style (Aesthetic style code precedes selected model number below, e.g., KC1117)

KL1017 Kadia Luxe Mobile Healthcare Recliner - Infinite Position Non-Locking Back

COM	Dillon/Carson	A ₅	B ₆	C ₇	D ₈	E ₉	F ₁₀	G ₁₁	H ₁₂	I ₁₃
6059	6139	6189	6259	6349	6519	6639	6869	7189	7639	8139

KL1117 Kadia Luxe Mobile Healthcare Recliner - Infinite Position Locking Back

COM	Dillon/Carson	A ₅	B ₆	C ₇	D ₈	E ₉	F ₁₀	G ₁₁	H ₁₂	I ₁₃
6329	6439	6449	6529	6669	6819	6969	7199	7499	8159	8799

KLC1017 Kadia Luxe Mobile Healthcare Chaise Recliner - Infinite Position Non-Locking Back

COM	Dillon/Carson	A ₅	B ₆	C ₇	D ₈	E ₉	F ₁₀	G ₁₁	H ₁₂	I ₁₃
6299	6419	6489	6669	6819	7079	7269	7639	8069	8519	8999

KLC1117 Kadia Luxe Mobile Healthcare Chaise Recliner - Infinite Position Locking Back

COM	Dillon/Carson	A ₅	B ₆	C ₇	D ₈	E ₉	F ₁₀	G ₁₁	H ₁₂	I ₁₃
6579	6719	6769	6949	7139	7379	7619	7949	8389	8949	9479

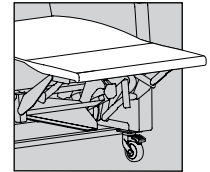

Chaise Models

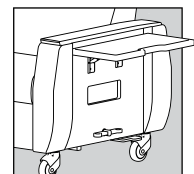

Side Detail

Dimensions

KL1017 KL1117 KLC1017 KLC1117	Overall			Seat			Back H	Arm H	Kick Out Seat D	Recline D	Distance from Wall
	W	D	H	W	D	H					
	35	39	47	24	22	21.5	28	26.5	40	76.5	17.5

General Info

COM: 6 yds
w/ Chaise COM: 7 yds
Wt Cap: 650 lb
Unit Weight: 208 lb

Available Options

ARM CAP OPTIONS

See pg 2 for finishes

U	Urethane	Standard
J1	Solid Surface - Group 1	1139
J2	Solid Surface - Group 2	1339
T	Thermofoil	229

CASTER OPTIONS

Q3	3" - Dual Wheel Central Locking System	No Charge
Q4	4" - Central Lock & Steer System	Standard
Q5	5" - Central Lock & Steer System	119

HEAT/MASSAGE OPTIONS (IEC 60601-1 CERTIFIED)

Wand Controls		
HW	Heat	1139
HMW	Heat & Massage	1369
In-Arm Controls		
H	Heat	849
HM	Heat & Massage	1119

ADDITIONAL FEATURES & OPTIONS

PB	Push Bar	Standard
EG	Protective Edge Guard	Standard
QR	Additional Quick Release Accessory Bracket	69
CAL	CAL TB133	See pg 9
Z	Multi Cover	Use Pricing for Highest Grade

PATIENT WELLNESS & COMFORT OPTIONS

ABP	Adjustable Back Pad (COM 1.75 yds)	
	Textile Grades COM-B	459
	Textile Grades C-I	569
AHP	Adjustable Head Rest Pillow (COM 1 yd)	339
DP	Dual IV Poles & Brackets ¹	498
FBH	Foley Bag Holder	89
FT	Foot Tray	279
IV	IV Pole & Bracket ¹	249
LC	LiquiCell	229
LCKFR	Orthopedic Locking Footrest	399
MBB	Moisture Barrier (Back)	59
MBS	Moisture Barrier (Seat)	59
MR	Monitor Arm (right side facing) ^{1,2}	849
MTR	Monitor Arm with Tray (right side facing) ^{1,2}	949
PR1	Paper Roll Holder ³	229
TE	Trendelenburg	339
USB	USB Power Outlet (IEC 60601-1 Certified)	459

TRAY TABLE OPTIONS

KL-FST	Kadia Luxe Folding Side Tray	Standard
--------	------------------------------	----------

Refer to pg 107 for full option details and images

¹Includes QR bracket connection installed on recliner

²Standard on right side (facing). Replace "R" with "L" for left side (facing) option where available.

³Takes place of Push Bar. Paper sold separately.



DURABLE® 650 SERIES

Mobile Healthcare Recliners

Select Aesthetic Style (Denotes back & arm design)

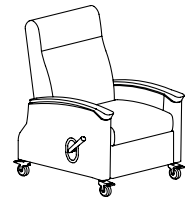

Select Functional Style (Aesthetic style code precedes selected model number below, e.g., KC1117)

5017 Mobile Healthcare Recliner - Infinite Position Non-Locking Back

COM	Dillon/Carson	A ₅	B ₆	C ₇	D ₈	E ₉	F ₁₀	G ₁₁	H ₁₂	I ₁₃
4279	4349	4449	4619	4879	5089	5359	5709	7379	7899	8419

5117 Mobile Healthcare Recliner - Infinite Position Locking Back

COM	Dillon/Carson	A ₅	B ₆	C ₇	D ₈	E ₉	F ₁₀	G ₁₁	H ₁₂	I ₁₃
4619	4679	4789	4979	5239	5459	5749	6059	7729	8289	8819

C5017 Mobile Healthcare Chaise Recliner - Infinite Position Non-Locking Back

COM	Dillon/Carson	A ₅	B ₆	C ₇	D ₈	E ₉	F ₁₀	G ₁₁	H ₁₂	I ₁₃
4519	4619	4759	5019	5359	5649	5999	6469	8259	8799	9319

C5117 Mobile Healthcare Chaise Recliner - Infinite Position Locking Back

COM	Dillon/Carson	A ₅	B ₆	C ₇	D ₈	E ₉	F ₁₀	G ₁₁	H ₁₂	I ₁₃
4859	4959	5099	5369	5719	6009	6389	6819	8619	9079	9599

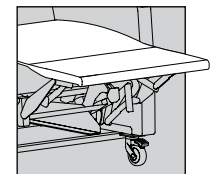

Chaise Models

Dimensions

Model	Overall			Seat			Back H	Arm H	Kick Out Seat D	Recline D	Distance from Wall
	W	D	H	W	D	H					
H5017 H5117 HC5017 HC5117	34	38	47	24	21	21.5	26	28	40	76	20

General Info

COM: 6 yds
w/ Chaise COM: 7 yds
Wt Cap: 650 lb
Unit Weight: 168 lb

Available Options

ARM CAP OPTIONS

See pg 2 for finishes

U	Urethane (black only in Harmony style)	Standard
---	--	----------

CASTER OPTIONS

S4	4" - (2) Caster Lock & Steer System	569
4S3R1	4" - (3) Swivel/(1) Rigid Locking Casters	Standard
4S4	4" - (4) Swivel Locking Casters	39

HEAT/MASSAGE OPTIONS (IEC 60601-1 CERTIFIED)

Wand Controls

HW	Heat	1139
HMW	Heat & Massage	1369

In-Arm Controls

H	Heat	849
HM	Heat & Massage	1119

ADDITIONAL FEATURES & OPTIONS

PB	Push Bar	Standard
EG	Protective Edge Guard	Standard
QR	Additional Quick Release Accessory Bracket	69
CAL	CAL TB133	See pg 9
Z	Multi Cover	Use Pricing for Highest Grade

PATIENT WELLNESS & COMFORT OPTIONS

ABP	Adjustable Back Pad (COM 1.75 yds)	
	Textile Grades COM-B	459
	Textile Grades C-I	569
AHP	Adjustable Head Rest Pillow (COM 1 yd)	339
DP	Dual IV Poles & Brackets ¹	498
FBH	Foley Bag Holder	89
FT	Foot Tray	279
IV	IV Pole & Bracket ¹	249
LC	LiquiCell	229
LCKFR	Orthopedic Locking Footrest	399
MBB	Moisture Barrier (Back)	59
MBS	Moisture Barrier (Seat)	59
MR	Monitor Arm (right side facing) ^{1,2}	849
MTR	Monitor Arm with Tray (right side facing) ^{1,2}	949
PR1	Paper Roll Holder ³	229
TE	Trendelenburg	339
USB	USB Power Outlet (IEC 60601-1 Certified)	459
WR	Wrist Restraint Mounts (pair)	229

TRAY TABLE OPTIONS

TSR1	Adjustable (Right) Side Tray ^{1,2,5}	399
TD3	Dual Adjustable Side Trays (TSR1 & TSL1) ^{1,5}	798
LFSTR	Large Folding (Right) Side Tray ⁴	249
LFSTRCH	Large Folding Cup Holder (Right) Side Tray	319
PLFSTR	Padded Large Folding (Right) Side Tray	379
SFSTR	Small Folding (Right) Side Tray ⁴	249

Refer to pg 107 for full option details and images

¹Includes QR bracket connection installed on recliner

²Standard on right side (facing). Replace "R" with "L" for left side (facing) option where available.

³Takes place of Push Bar. Paper sold separately.

⁴Contact customer service for solid surface pricing

⁵Over the lap tray function recommended in seated position.



DURABLE® 650 SERIES

Mobile Healthcare Recliners | Wingback

Select Aesthetic Style (Denotes back & arm design)

E EV Wingback

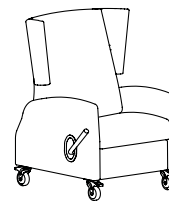
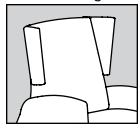

Select Functional Style (Aesthetic style code precedes selected model number below, e.g., KC1117)

2017 Mobile Healthcare Wingback Recliner - Infinite Position Non-Locking Back

COM	Dillon/Carson	A ₅	B ₆	C ₇	D ₈	E ₉	F ₁₀	G ₁₁	H ₁₂	I ₁₃
4849	4919	5019	5209	5469	5649	5969	6279	7869	8259	8679

2117 Mobile Healthcare Wingback Recliner - Infinite Position Locking Back

COM	Dillon/Carson	A ₅	B ₆	C ₇	D ₈	E ₉	F ₁₀	G ₁₁	H ₁₂	I ₁₃
5119	5209	5279	5499	5749	5969	6279	6639	8209	8549	8949

C2017 Mobile Healthcare Wingback Chaise Recliner - Infinite Position Non-Locking Back

COM	Dillon/Carson	A ₅	B ₆	C ₇	D ₈	E ₉	F ₁₀	G ₁₁	H ₁₂	I ₁₃
5109	5209	5359	5599	5949	6219	6599	7039	8609	8949	9469

C2117 Mobile Healthcare Wingback Chaise Recliner - Infinite Position Locking Back

COM	Dillon/Carson	A ₅	B ₆	C ₇	D ₈	E ₉	F ₁₀	G ₁₁	H ₁₂	I ₁₃
5379	5499	5639	5909	6239	6519	6939	7399	8939	9469	9999

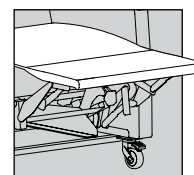

Chaise Models

Dimensions

	Overall			Seat			Back H	Arm H	Kick Out Seat D	Recline D	Distance from Wall
	W	D	H	W	D	H					
E2017 E2117 EC2017 EC2117	33.5	34.5	47.5	24	21	21.5	28.5	28	40	75.5	20

General Info

COM: 6 yds
w/ Chaise COM: 7 yds
Wt Cap: 650 lb
Unit Weight: 176 lb

Available Options

ARM CAP OPTIONS		See pg 2 for finishes	PATIENT WELLNESS & COMFORT OPTIONS	
U	Urethane	169	ABP	Adjustable Back Pad (COM 1.75 yds) Textile Grades COM-B 459 Textile Grades C-I 569
J1	Solid Surface - Group 1	619	AHP	Adjustable Head Rest Pillow (COM 1 yd) 339
J2	Solid Surface - Group 2	819	DP	Dual IV Poles & Brackets ¹ 498
F	Fully Upholstered Arms	Standard	FBH	Foley Bag Holder 89
CASTER OPTIONS			FT	Foot Tray 279
Q3	3" - Dual Wheel Central Locking System	1019	IV	IV Pole & Bracket ¹ 249
Q4	4" - Central Lock & Steer System	1019	LC	LiquiCell 229
Q5	5" - Central Lock & Steer System	1139	LCKFR	Orthopedic Locking Footrest 399
S4	4" - (2) Caster Lock & Steer System	569	MBB	Moisture Barrier (Back) 59
4S3R1	4" - (3) Swivel/(1) Rigid Locking Casters	Standard	MBS	Moisture Barrier (Seat) 59
4S4	4" - (4) Swivel Locking Casters	39	MR	Monitor Arm (right side facing) ^{1,2} 849
HEAT/MESSAGE OPTIONS (IEC 60601-1 CERTIFIED)			MTR	Monitor Arm with Tray (right side facing) ^{1,2} 949
<i>Wand Controls</i>			PR1	Paper Roll Holder ³ 229
HW	Heat	1139	TE	Trendelenburg 339
HMW	Heat & Massage	1369	USB	USB Power Outlet (IEC 60601-1 Certified) 459
<i>In-Arm Controls</i>			WR	Wrist Restraint Mounts (pair) 229
H	Heat	849	TRAY TABLE OPTIONS	
HM	Heat & Massage	1119	TSR1	Adjustable (Right) Side Tray ^{1,2,5} 399
ADDITIONAL FEATURES & OPTIONS			TD3	Dual Adjustable Side Trays (TSR1 & TSL1) ^{1,5} 798
PB	Push Bar	Standard	LFSTR	Large Folding (Right) Side Tray ⁴ 249
EG	Protective Edge Guard	Standard	LFSTRCH	Large Folding Cup Holder (Right) Side Tray 319
QR	Additional Quick Release Accessory Bracket	69	PLFSTR	Padded Large Folding (Right) Side Tray 379
CAL	CAL TB133	See pg 9	SFSTR	Small Folding (Right) Side Tray ⁴ 249
Z	Multi Cover	Use Pricing for Highest Grade	*Refer to pg 107 for full option details and images*	

¹Includes QR bracket connection installed on recliner
²Standard on right side (facing). Replace "R" with "L" for left side (facing) option where available.
³Takes place of Push Bar. Paper sold separately.

⁴Contact customer service for solid surface pricing
⁵Over the lap tray function recommended in seated position.



DURABLE® 650 SERIES

Mobile Healthcare Recliners | Patient Transfer

Select Aesthetic Style *(Denotes back & arm design)*

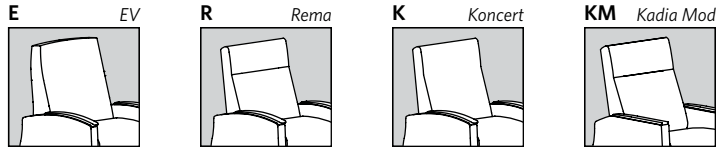

Single Fold Down Arm
(Koncert style pictured)

Select Functional Style *(Aesthetic style code precedes selected model number below, e.g., KC1117)*

1067	Mobile Healthcare Recliner - Infinite Position Non-Locking Back - Single Fold Down Arm									
COM	<i>Dillon/Carson</i>	A ₅	B ₆	C ₇	D ₈	E ₉	F ₁₀	G ₁₁	H ₁₂	I ₁₃
4749	4789	4899	5079	5339	5529	5819	6169	7559	7899	8289
1167	Mobile Healthcare Recliner - Infinite Position Locking Back - Single Fold Down Arm									
COM	<i>Dillon/Carson</i>	A ₅	B ₆	C ₇	D ₈	E ₉	F ₁₀	G ₁₁	H ₁₂	I ₁₃
5019	5089	5179	5369	5639	5839	6149	6489	7879	8289	8679
C1067	Mobile Healthcare Chaise Recliner - Infinite Position Non-Locking Back - Single Fold Down Arm									
COM	<i>Dillon/Carson</i>	A ₅	B ₆	C ₇	D ₈	E ₉	F ₁₀	G ₁₁	H ₁₂	I ₁₃
4929	5039	5199	5429	5759	6019	6449	6839	8519	8949	9469
C1167	Mobile Healthcare Chaise Recliner - Infinite Position Locking Back - Single Fold Down Arm									
COM	<i>Dillon/Carson</i>	A ₅	B ₆	C ₇	D ₈	E ₉	F ₁₀	G ₁₁	H ₁₂	I ₁₃
5229	5319	5459	5729	6039	6319	6719	7169	8839	9199	9739

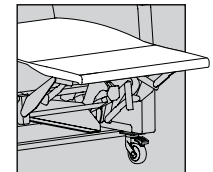

Chaise Models

NOTE: Transfer arm standard on right side (facing). If specified on left side, handle will be placed on right side and vice versa.

Dimensions

E1067 E1167 EC1067 EC1167 R1067 R1167 RC1067 RC1167 K1067 K1167 KC1067 KC1167 KM1067 KM1167 KMC1067 KMC1167	Overall			Seat			Back H	Arm H	Kick Out Seat D	Recline D	Distance from Wall
	W	D	H	W	D	H					
	33.5	34.5	47.5	24	21	21.5	28.5	27	40	75.5	20
	33.5	38.5	47	24	21	21.5	28	27	40	76.5	20
	33.5	38.5	47	24	22	22	28	26.5	40	76.5	20

General Info

COM: 7 yds
w/ Chaise COM: 8 yds
Wt Cap: 650 lb
Unit Weight: 166 lb

Available Options

ARM CAP OPTIONS		See pg 2 for finishes	PATIENT WELLNESS & COMFORT OPTIONS	
U	Urethane	Standard	ABP	Adjustable Back Pad (COM 1.75 yds)
J1	Solid Surface - Group 1	619		Textile Grades COM-B 459
J2	Solid Surface - Group 2	819		Textile Grades C-I 569
CASTER OPTIONS			AHP	Adjustable Head Rest Pillow (COM 1 yd) 339
Q3	3" - Dual Wheel Central Locking System	1019	DP	Dual IV Poles & Brackets ¹ 498
Q4	4" - Central Lock & Steer System	1019	FBH	Foley Bag Holder 89
Q5	5" - Central Lock & Steer System	1139	FT	Foot Tray 279
S4	4" - (2) Caster Lock & Steer System	569	IV	IV Pole & Bracket ¹ 249
4S3R1	4" - (3) Swivel/(1) Rigid Locking Casters	Standard	LC	LiquiCell 229
4S4	4" - (4) Swivel Locking Casters	39	LCKFR	Orthopedic Locking Footrest 399
HEAT/MESSAGE OPTIONS (IEC 60601-1 CERTIFIED)			MBB	Moisture Barrier (Back) 59
<i>Wand Controls</i>			MBS	Moisture Barrier (Seat) 59
HW	Heat	1139	MR	Monitor Arm (right side facing) ^{1,2} 849
HMW	Heat & Massage	1369	MTR	Monitor Arm with Tray (right side facing) ^{1,2} 949
<i>In-Arm Controls</i>			PR1	Paper Roll Holder ³ 229
H	Heat	849	TE	Trendelenburg 339
HM	Heat & Massage	1119	USB	USB Power Outlet (IEC 60601-1 Certified) 459
ADDITIONAL FEATURES & OPTIONS			WR	Wrist Restraint Mounts (pair) 229
PB	Push Bar	Standard	TRAY TABLE OPTIONS	
EG	Protective Edge Guard	Standard	TSL1	Adjustable (Left) Side Tray, on Stationary Arm ¹⁵ 399
QR	Additional Quick Release Accessory Bracket	69	TSR167	Adjustable (Right) Side Tray, on Fold Down Arm ¹⁵ 449
CAL	CAL TB133	See pg 9	FOLD DOWN TRANSFER ARM SPECIFIC	
Z	Multi Cover	Use Pricing for Highest Grade	HC	Hinge Cover Standard

Refer to pg 107 for full option details and images

¹Includes QR bracket connection installed on recliner

²Standard on right side (facing). Replace "R" with "L" for left side (facing) option where available.

³Takes place of Push Bar. Paper sold separately.

⁴Contact customer service for solid surface pricing

⁵Over the lap tray function recommended in seated position.

DURABLE® 650 SERIES

Mobile Healthcare Recliners | Patient Transfer

Select Aesthetic Style (Denotes back & arm design)

E EV-Narrow Arm

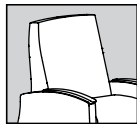

Single Fold Down Arm

Select Functional Style (Aesthetic style code precedes selected model number below, e.g., KC117)

4067 Mobile Healthcare Recliner - Narrow Arms - Infinite Position Non-Locking Back - Single Fold Down Arm

COM	Dillon/Carson	A ₅	B ₆	C ₇	D ₈	E ₉	F ₁₀	G ₁₁	H ₁₂	I ₁₃
4689	4749	4849	5029	5289	5489	5769	6119	7509	7999	8549

4167 Mobile Healthcare Recliner - Narrow Arms - Infinite Position Locking Back - Single Fold Down Arm

COM	Dillon/Carson	A ₅	B ₆	C ₇	D ₈	E ₉	F ₁₀	G ₁₁	H ₁₂	I ₁₃
4979	5039	5109	5319	5569	5789	6089	6199	7579	8099	8549

C4067 Mobile Healthcare Chaise Recliner - Narrow Arms - Infinite Position Non-Locking Back - Single Fold Down Arm

COM	Dillon/Carson	A ₅	B ₆	C ₇	D ₈	E ₉	F ₁₀	G ₁₁	H ₁₂	I ₁₃
4879	4999	5119	5369	5709	5969	6329	6789	8469	8819	9349

C4167 Mobile Healthcare Chaise Recliner - Narrow Arms - Infinite Position Locking Back - Single Fold Down Arm

COM	Dillon/Carson	A ₅	B ₆	C ₇	D ₈	E ₉	F ₁₀	G ₁₁	H ₁₂	I ₁₃
5169	5269	5409	5669	5999	6279	6679	6859	8539	9079	9599

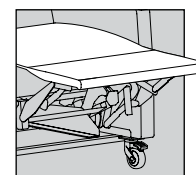

Chaise Models

NOTE: Transfer arm standard on right side (facing). If specified on left side, handle will be placed on right side and vice versa.

Dimensions

E4067 E4167 EC4067 EC4167	Overall			Seat			Back H	Arm H	Kick Out Seat D	Recline D	Distance from Wall
	W	D	H	W	D	H					
	32.5	34.5	47.5	24	21	21.5	28.5	27	39	75.5	20

General Info

COM: 7 yds
w/ Chaise COM: 8 yds
Wt Cap: 650 lb
Unit Weight: 155 lb

Available Options

ARM CAP OPTIONS

See pg 2 for finishes

U	Urethane	Standard
J1	Solid Surface - Group 1	619
J2	Solid Surface - Group 2	819

CASTER OPTIONS

Q3	3" - Dual Wheel Central Locking System	1019
Q4	4" - Central Lock & Steer System	1019
Q5	5" - Central Lock & Steer System	1139
S4	4" - (2) Caster Lock & Steer System	569
4S3R1	4" - (3) Swivel/(1) Rigid Locking Casters	Standard
4S4	4" - (4) Swivel Locking Casters	39

HEAT/MASSAGE OPTIONS (IEC 60601-1 CERTIFIED)

Wand Controls

HW	Heat	1139
HMW	Heat & Massage	1369

In-Arm Controls

H	Heat	849
HM	Heat & Massage	1119

ADDITIONAL FEATURES & OPTIONS

PB	Push Bar	Standard
EG	Protective Edge Guard	Standard
QR	Additional Quick Release Accessory Bracket	69
CAL	CAL TB133	See pg 9
Z	Multi Cover	Use Pricing for Highest Grade

PATIENT WELLNESS & COMFORT OPTIONS

ABP	Adjustable Back Pad (COM 1.75 yds)	
	Textile Grades COM-B	459
	Textile Grades C-I	569
AHP	Adjustable Head Rest Pillow (COM 1 yd)	339
DP	Dual IV Poles & Brackets ¹	498
FBH	Foley Bag Holder	89
FT	Foot Tray	279
IV	IV Pole & Bracket ¹	249
LC	LiquiCell	229
LCKFR	Orthopedic Locking Footrest	399
MBB	Moisture Barrier (Back)	59
MBS	Moisture Barrier (Seat)	59
MR	Monitor Arm (right side facing) ^{1,2}	849
MTR	Monitor Arm with Tray (right side facing) ^{1,2}	949
PR1	Paper Roll Holder ³	229
TE	Trendelenburg	339
USB	USB Power Outlet (IEC 60601-1 Certified)	459
WR	Wrist Restraint Mounts (pair)	229

TRAY TABLE OPTIONS

TSL1	Adjustable (Left) Side Tray, on Stationary Arm ^{1,5}	399
TSR167	Adjustable (Right) Side Tray, on Fold Down Arm ^{1,5}	449

FOLD DOWN TRANSFER ARM SPECIFIC

HC	Hinge Cover	Standard
----	-------------	----------

Refer to pg 107 for full option details and images

¹Includes QR bracket connection installed on recliner

²Standard on right side (facing). Replace "R" with "L" for left side (facing) option where available.

³Takes place of Push Bar. Paper sold separately.

⁴Contact customer service for solid surface pricing

⁵Over the lap tray function recommended in seated position.



DURABLE® 650 SERIES

Mobile Healthcare Recliners | Patient Transfer, Wingback

Select Aesthetic Style (Denotes back & arm design)

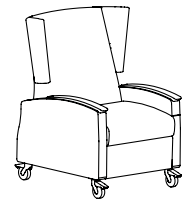

Single Fold Down Arm

Select Functional Style (Aesthetic style code precedes selected model number below, e.g., KC117)

2067 Mobile Healthcare Wingback Recliner - Infinite Position Non-Locking Back - Single Fold Down Arm

COM	Dillon/Carson	A ₅	B ₆	C ₇	D ₈	E ₉	F ₁₀	G ₁₁	H ₁₂	I ₁₃
5649	5669	5769	5969	6199	6359	6679	6969	8339	8819	9339

2167 Mobile Healthcare Wingback Recliner - Infinite Position Locking Back - Single Fold Down Arm

COM	Dillon/Carson	A ₅	B ₆	C ₇	D ₈	E ₉	F ₁₀	G ₁₁	H ₁₂	I ₁₃
5909	5969	6039	6219	6469	6689	6979	7319	8659	9199	9679

C2067 Mobile Healthcare Chaise Wingback Recliner - Infinite Position Non-Locking Back - Single Fold Down Arm

COM	Dillon/Carson	A ₅	B ₆	C ₇	D ₈	E ₉	F ₁₀	G ₁₁	H ₁₂	I ₁₃
5839	5909	6039	6289	6609	6859	7239	7649	9289	9739	10259

C2167 Mobile Healthcare Chaise Wingback Recliner - Infinite Position Locking Back - Single Fold Down Arm

COM	Dillon/Carson	A ₅	B ₆	C ₇	D ₈	E ₉	F ₁₀	G ₁₁	H ₁₂	I ₁₃
6119	6199	6309	6549	6899	7169	7539	7989	9619	9999	10499

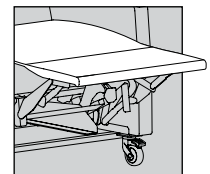

Chaise Models

NOTE: Transfer arm standard on right side (facing). If specified on left side, handle will be placed on right side and vice versa.

Dimensions

E2067 E2167 EC2067 EC2167	Overall			Seat			Back H	Arm H	Kick Out Seat D	Recline D	Distance from Wall
	W	D	H	W	D	H					
	33.5	34.5	47.5	24	21	21.5	28.5	27	39	75.5	20

General Info

COM: 7 yds
w/ Chaise COM: 8 yds
Wt Cap: 650 lb
Unit Weight: 188 lb

Available Options

ARM CAP OPTIONS

See pg 2 for finishes

U	Urethane	Standard
J1	Solid Surface - Group 1	619
J2	Solid Surface - Group 2	819

CASTER OPTIONS

Q3	3" - Dual Wheel Central Locking System	1019
Q4	4" - Central Lock & Steer System	1019
Q5	5" - Central Lock & Steer System	1139
S4	4" - (2) Caster Lock & Steer System	569
4S3R1	4" - (3) Swivel/(1) Rigid Locking Casters	Standard
4S4	4" - (4) Swivel Locking Casters	39

HEAT/MESSAGE OPTIONS (IEC 60601-1 CERTIFIED)

Wand Controls

HW	Heat	1139
HMW	Heat & Massage	1369

In-Arm Controls

H	Heat	849
HM	Heat & Massage	1119

ADDITIONAL FEATURES & OPTIONS

PB	Push Bar	Standard
EG	Protective Edge Guard	Standard
QR	Additional Quick Release Accessory Bracket	69
CAL	CAL TB133	See pg 9
Z	Multi Cover	Use Pricing for Highest Grade

PATIENT WELLNESS & COMFORT OPTIONS

ABP	Adjustable Back Pad (COM 1.75 yds)	
	Textile Grades COM-B	459
	Textile Grades C-I	569
AHP	Adjustable Head Rest Pillow (COM 1 yd)	339
DP	Dual IV Poles & Brackets ¹	498
FBH	Foley Bag Holder	89
FT	Foot Tray	279
IV	IV Pole & Bracket ¹	249
LC	LiquiCell	229
LCKFR	Orthopedic Locking Footrest	399
MBB	Moisture Barrier (Back)	59
MBS	Moisture Barrier (Seat)	59
MR	Monitor Arm (right side facing) ^{1,2}	849
MTR	Monitor Arm with Tray (right side facing) ^{1,2}	949
PR1	Paper Roll Holder ³	229
TE	Trendelenburg	339
USB	USB Power Outlet (IEC 60601-1 Certified)	459
WR	Wrist Restraint Mounts (pair)	229

TRAY TABLE OPTIONS

TSL1	Adjustable (Left) Side Tray, on Stationary Arm ^{1,5}	399
TSR167	Adjustable (Right) Side Tray, on Fold Down Arm ^{1,5}	449

FOLD DOWN TRANSFER ARM SPECIFIC

HC	Hinge Cover	Standard
----	-------------	----------

Refer to pg 107 for full option details and images

¹Includes QR bracket connection installed on recliner

²Standard on right side (facing). Replace "R" with "L" for left side (facing) option where available.

³Takes place of Push Bar. Paper sold separately.

⁴Contact customer service for solid surface pricing

⁵Over the lap tray function recommended in seated position.



DURABLE® 650 SERIES

Mobile Healthcare Recliners | Patient Transfer

Select Aesthetic Style (Denotes back & arm design)

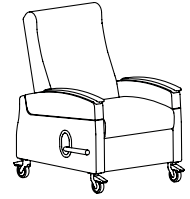
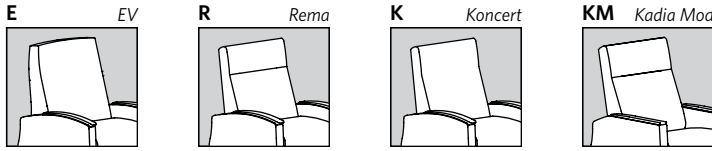

Select Functional Style (Aesthetic style code precedes selected model number below, e.g., KC1177)

1062 Mobile Healthcare Recliner - Infinite Position Non-Locking Back - Dual Fold Down Arms

COM	Dillon/Carson	A ₅	B ₆	C ₇	D ₈	E ₉	F ₁₀	G ₁₁	H ₁₂	I ₁₃
5419	5479	5549	5739	5989	6179	6479	6789	8159	8629	8949

1162 Mobile Healthcare Recliner - Infinite Position Locking Back - Dual Fold Down Arms

COM	Dillon/Carson	A ₅	B ₆	C ₇	D ₈	E ₉	F ₁₀	G ₁₁	H ₁₂	I ₁₃
6089	6139	6219	6389	6639	6789	7099	7429	8759	9199	9599

C1062 Mobile Healthcare Chaise Recliner - Infinite Position Non-Locking Back - Dual Fold Down Arms

COM	Dillon/Carson	A ₅	B ₆	C ₇	D ₈	E ₉	F ₁₀	G ₁₁	H ₁₂	I ₁₃
5619	5709	5829	6059	6419	6669	7029	7469	8949	9469	10129

C1162 Mobile Healthcare Chaise Recliner - Infinite Position Locking Back - Dual Fold Down Arms

COM	Dillon/Carson	A ₅	B ₆	C ₇	D ₈	E ₉	F ₁₀	G ₁₁	H ₁₂	I ₁₃
6289	6359	6489	6719	7039	7289	7689	8099	9559	10129	10529

Dual Fold Down Arms
(Koncert style pictured)

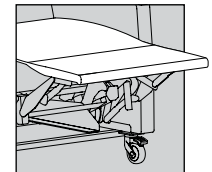

Chaise Models

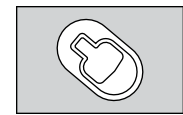

Locking Back Lever
(located on outside arm on applicable models)

Dimensions

E1062 E1162 EC1062 EC1162	Overall			Seat			Back H	Arm H	Kick Out Seat D	Recline D	Distance from Wall
	W	D	H	W	D	H					
R1062 R1162 RC1062 RC1162	33.5	34.5	47.5	24	21	21.5	28.5	27	40	75.5	20
K1062 K1162 KC1062 KC1162	33.5	38.5	47	24	21	21.5	28	27	40	76.5	20
KM1062 KM1162 KMC1062 KMC1162	33.5	38.5	47	24	21	21.5	28	26.5	40	76.5	20

General Info

COM: 7 yds
w/ Chaise COM: 8 yds
Wt Cap: 650 lb
Unit Weight: 166 lb

Available Options

ARM CAP OPTIONS	See pg 2 for finishes	PATIENT WELLNESS & COMFORT OPTIONS		
U Urethane	Standard	ABP Adjustable Back Pad (COM 1.75 yds)		
J1 Solid Surface - Group 1	619	Textile Grades COM-B 459		
J2 Solid Surface - Group 2	819	Textile Grades C-I 569		
CASTER OPTIONS		AHP Adjustable Head Rest Pillow (COM 1 yd) 339		
Q3 3" - Dual Wheel Central Locking System	1019	DP Dual IV Poles & Brackets ¹ 498		
Q4 4" - Central Lock & Steer System	1019	FBH Foley Bag Holder 89		
Q5 5" - Central Lock & Steer System	1139	FT Foot Tray 279		
S4 4" - (2) Caster Lock & Steer System	569	IV IV Pole & Bracket ¹ 249		
4S3R1 4" - (3) Swivel/(1) Rigid Locking Casters	Standard	LC LiquiCell 229		
4S4 4" - (4) Swivel Locking Casters	39	LCKFR Orthopedic Locking Footrest 399		
HEAT/MASSAGE OPTIONS (IEC 60601-1 CERTIFIED)		MBB Moisture Barrier (Back) 59		
Wand Controls		MBS Moisture Barrier (Seat) 59		
HW Heat	1139	MR Monitor Arm (right side facing) ^{1,2} 849		
HMW Heat & Massage	1369	MTR Monitor Arm with Tray (right side facing) ^{1,2} 949		
ADDITIONAL FEATURES & OPTIONS		PR1 Paper Roll Holder ³ 229		
PB Push Bar	Standard	TE Trendelenburg 339		
EG Protective Edge Guard	Standard	USB USB Power Outlet (IEC 60601-1 Certified) 459		
QR Additional Quick Release Accessory Bracket	69	WR Wrist Restraint Mounts (pair) 229		
CAL CAL TB133	See pg 9	TRAY TABLE OPTIONS		
Z Multi Cover	Use Pricing for Highest Grade	TD362 Dual Adjustable Side Trays, on Fold Down Arms ^{1,5} 898	TSR167 Adjustable (Right) Side Tray, on Fold Down Arm ^{1,5} 449	TSL167 Adjustable (Left) Side Tray, on Fold Down Arm ^{1,5} 449
		FOLD DOWN TRANSFER ARM SPECIFIC		
		HC Hinge Cover	Standard	

Refer to pg 107 for full option details and images

¹Includes QR bracket connection installed on recliner

²Standard on right side (facing). Replace "R" with "L" for left side (facing) option where available.

³Takes place of Push Bar. Paper sold separately.

⁴Contact customer service for solid surface pricing

⁵Over the lap tray function recommended in seated position.



DURABLE® 650 SERIES

Mobile Healthcare Recliners | Patient Transfer

Select Aesthetic Style (Denotes back & arm design)

E EV-Narrow Arm

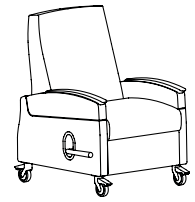
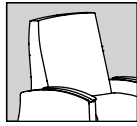

Dual Fold Down Arms

Select Functional Style (Aesthetic style code precedes selected model number below, e.g., KC117)

4062 Mobile Healthcare Recliner - Narrow Arms - Infinite Position Non-Locking Back - Dual Fold Down Arms

COM	Dillon/Carson	A ₅	B ₆	C ₇	D ₈	E ₉	F ₁₀	G ₁₁	H ₁₂	I ₁₃
5359	5419	5499	5689	5939	6129	6409	6739	8119	8689	9159

4162 Mobile Healthcare Recliner - Narrow Arms - Infinite Position Locking Back - Dual Fold Down Arms

COM	Dillon/Carson	A ₅	B ₆	C ₇	D ₈	E ₉	F ₁₀	G ₁₁	H ₁₂	I ₁₃
6039	6059	6149	6309	6579	6749	7029	7369	8699	9079	9599

C4062 Mobile Healthcare Chaise Recliner - Narrow Arms - Infinite Position Non-Locking Back - Dual Fold Down Arms

COM	Dillon/Carson	A ₅	B ₆	C ₇	D ₈	E ₉	F ₁₀	G ₁₁	H ₁₂	I ₁₃
5559	5649	5789	6019	6349	6599	6979	7429	8909	9199	9739

C4162 Mobile Healthcare Chaise Recliner - Narrow Arms - Infinite Position Locking Back - Dual Fold Down Arms

COM	Dillon/Carson	A ₅	B ₆	C ₇	D ₈	E ₉	F ₁₀	G ₁₁	H ₁₂	I ₁₃
6249	6309	6449	6679	6999	7239	7599	8049	9659	10129	10659

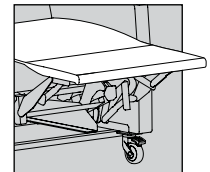

Chaise Models

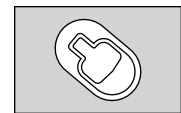

Locking Back Lever (located on outside arm on applicable models)

Dimensions

E4062 E4162 EC4062 EC4162	Overall			Seat			Back H	Arm H	Kick Out Seat D	Recline D	Distance from Wall
	W	D	H	W	D	H					
	32.5	34.5	47.5	24	21	21.5	28.5	27	39	75.5	20

General Info

COM: 7 yds
w/ Chaise COM: 8 yds
Wt Cap: 650 lb
Unit Weight: 155 lb

Available Options

ARM CAP OPTIONS

See pg 2 for finishes

U	Urethane	Standard
J1	Solid Surface - Group 1	619
J2	Solid Surface - Group 2	819

CASTER OPTIONS

Q3	3" - Dual Wheel Central Locking System	1019
Q4	4" - Central Lock & Steer System	1019
Q5	5" - Central Lock & Steer System	1139
S4	4" - (2) Caster Lock & Steer System	569
4S3R1	4" - (3) Swivel/(1) Rigid Locking Casters	Standard
4S4	4" - (4) Swivel Locking Casters	39

HEAT/MESSAGE OPTIONS (IEC 60601-1 CERTIFIED)

Wand Controls

HW	Heat	1139
HMW	Heat & Massage	1369

ADDITIONAL FEATURES & OPTIONS

PB	Push Bar	Standard
EG	Protective Edge Guard	Standard
QR	Additional Quick Release Accessory Bracket	69
CAL	CAL TB133	See pg 9
Z	Multi Cover	Use Pricing for Highest Grade

PATIENT WELLNESS & COMFORT OPTIONS

ABP	Adjustable Back Pad (COM 1.75 yds)	
	Textile Grades COM-B	459
	Textile Grades C-I	569
AHP	Adjustable Head Rest Pillow (COM 1 yd)	339
DP	Dual IV Poles & Brackets ¹	498
FBH	Foley Bag Holder	89
FT	Foot Tray	279
IV	IV Pole & Bracket ¹	249
LC	LiquiCell	229
LCKFR	Orthopedic Locking Footrest	399
MBB	Moisture Barrier (Back)	59
MBS	Moisture Barrier (Seat)	59
MR	Monitor Arm (right side facing) ^{1,2}	849
MTR	Monitor Arm with Tray (right side facing) ^{1,2}	949
PR1	Paper Roll Holder ³	229
TE	Trendelenburg	339
USB	USB Power Outlet (IEC 60601-1 Certified)	459
WR	Wrist Restraint Mounts (pair)	229

TRAY TABLE OPTIONS

TD362	Dual Adjustable Side Trays, on Fold Down Arms ^{1,5}	898
TSR167	Adjustable (Right) Side Tray, on Fold Down Arm ^{1,5}	449
TSL167	Adjustable (Left) Side Tray, on Fold Down Arm ^{1,5}	449

FOLD DOWN TRANSFER ARM SPECIFIC

HC	Hinge Cover	Standard
----	-------------	----------

Refer to pg 107 for full option details and images

¹Includes QR bracket connection installed on recliner

²Standard on right side (facing). Replace "R" with "L" for left side (facing) option where available.

³Takes place of Push Bar. Paper sold separately.

⁴Contact customer service for solid surface pricing

⁵Over the lap tray function recommended in seated position.



Select Aesthetic Style (Denotes back & arm design)

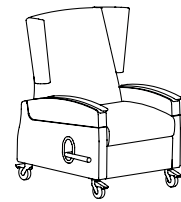

Dual Fold Down Arms

Select Functional Style (Aesthetic style code precedes selected model number below, e.g., KC117)

2062 Mobile Healthcare Wingback Recliner - Infinite Position Non-Locking Back - Dual Fold Down Arms

COM	Dillon/Carson	A ₅	B ₆	C ₇	D ₈	E ₉	F ₁₀	G ₁₁	H ₁₂	I ₁₃
6309	6329	6429	6599	6839	6999	7299	7629	8949	9339	9869

2162 Mobile Healthcare Wingback Recliner - Infinite Position Locking Back - Dual Fold Down Arms

COM	Dillon/Carson	A ₅	B ₆	C ₇	D ₈	E ₉	F ₁₀	G ₁₁	H ₁₂	I ₁₃
6989	6999	7059	7249	7479	7639	7939	8249	9709	9999	10399

C2062 Mobile Healthcare Chaise Wingback Recliner - Infinite Position Non-Locking Back - Dual Fold Down Arms

COM	Dillon/Carson	A ₅	B ₆	C ₇	D ₈	E ₉	F ₁₀	G ₁₁	H ₁₂	I ₁₃
6519	6559	6699	6939	7249	7489	7879	8299	9899	10259	10789

C2162 Mobile Healthcare Chaise Wingback Recliner - Infinite Position Locking Back - Dual Fold Down Arms

COM	Dillon/Carson	A ₅	B ₆	C ₇	D ₈	E ₉	F ₁₀	G ₁₁	H ₁₂	I ₁₃
7189	7229	7339	7599	7899	8129	8519	8919	10509	10999	11579

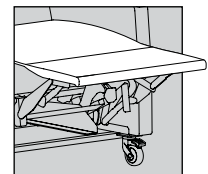

Chaise Models

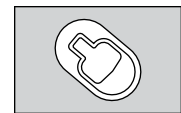

Locking Back Lever (located on outside arm on applicable models)

Dimensions

E2062 E2162 EC2062 EC2162	Overall			Seat			Back H	Arm H	Kick Out Seat D	Recline D	Distance from Wall
	W	D	H	W	D	H					
	33.5	34.5	47.5	24	21	21.5	28.5	27	40	75.5	20

General Info

COM: 7 yds
w/ Chaise COM: 8 yds
Wt Cap: 650 lb
Unit Weight: 188 lb

Available Options

ARM CAP OPTIONS

See pg 2 for finishes

U	Urethane	Standard
J1	Solid Surface - Group 1	619
J2	Solid Surface - Group 2	819

CASTER OPTIONS

Q3	3" - Dual Wheel Central Locking System	1019
Q4	4" - Central Lock & Steer System	1019
Q5	5" - Central Lock & Steer System	1139
S4	4" - (2) Caster Lock & Steer System	569
4S3R1	4" - (3) Swivel/(1) Rigid Locking Casters	Standard
4S4	4" - (4) Swivel Locking Casters	39

HEAT/MASSAGE OPTIONS (IEC 60601-1 CERTIFIED)

Wand Controls

HW	Heat	1139
HMW	Heat & Massage	1369

ADDITIONAL FEATURES & OPTIONS

PB	Push Bar	Standard
EG	Protective Edge Guard	Standard
QR	Additional Quick Release Accessory Bracket	69
CAL	CAL TB133	See pg 9
Z	Multi Cover	Use Pricing for Highest Grade

PATIENT WELLNESS & COMFORT OPTIONS

ABP	Adjustable Back Pad (COM 1.75 yds)	
	Textile Grades COM-B	459
	Textile Grades C-I	569
AHP	Adjustable Head Rest Pillow (COM 1 yd)	339
DP	Dual IV Poles & Brackets ¹	498
FBH	Foley Bag Holder	89
FT	Foot Tray	279
IV	IV Pole & Bracket ¹	249
LC	LiquiCell	229
LCKFR	Orthopedic Locking Footrest	399
MBB	Moisture Barrier (Back)	59
MBS	Moisture Barrier (Seat)	59
MR	Monitor Arm (right side facing) ^{1,2}	849
MTR	Monitor Arm with Tray (right side facing) ^{1,2}	949
PR1	Paper Roll Holder ³	229
TE	Trendelenburg	339
USB	USB Power Outlet (IEC 60601-1 Certified)	459
WR	Wrist Restraint Mounts (pair)	229

TRAY TABLE OPTIONS

TD362	Dual Adjustable Side Trays, on Fold Down Arms ^{1,5}	898
TSR167	Adjustable (Right) Side Tray, on Fold Down Arm ^{1,5}	449
TSL167	Adjustable (Left) Side Tray, on Fold Down Arm ^{1,5}	449

FOLD DOWN TRANSFER ARM SPECIFIC

HC	Hinge Cover	Standard
----	-------------	----------

Refer to pg 107 for full option details and images

¹Includes QR bracket connection installed on recliner

²Standard on right side (facing). Replace "R" with "L" for left side (facing) option where available.

³Takes place of Push Bar. Paper sold separately.

⁴Contact customer service for solid surface pricing

⁵Over the lap tray function recommended in seated position.



DURABLE® 650 SERIES

Mobile Healthcare Recliners | Patient Transfer

Select Aesthetic Style (Denotes back & arm design)

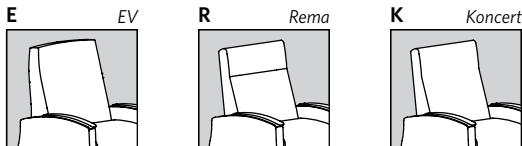

Single Removable Arm
(Koncert style pictured)

Select Functional Style (Aesthetic style code precedes selected model number below, e.g., KC117)

1047 Mobile Healthcare Recliner - Infinite Position Non-Locking Back - Single Removable Arm

COM	Dillon/Carson	A ₅	B ₆	C ₇	D ₈	E ₉	F ₁₀	G ₁₁	H ₁₂	I ₁₃
4749	4789	4899	5079	5339	5529	5819	6169	7559	7899	8289

1147 Mobile Healthcare Recliner - Infinite Position Locking Back - Single Removable Arm

COM	Dillon/Carson	A ₅	B ₆	C ₇	D ₈	E ₉	F ₁₀	G ₁₁	H ₁₂	I ₁₃
5019	5089	5179	5369	5639	5839	6149	6489	7879	8289	8679

C1047 Mobile Healthcare Chaise Recliner - Infinite Position Non-Locking Back - Single Removable Arm

COM	Dillon/Carson	A ₅	B ₆	C ₇	D ₈	E ₉	F ₁₀	G ₁₁	H ₁₂	I ₁₃
4929	5039	5199	5429	5759	6019	6409	6839	8519	8949	9469

C1147 Mobile Healthcare Chaise Recliner - Infinite Position Locking Back - Single Removable Arm

COM	Dillon/Carson	A ₅	B ₆	C ₇	D ₈	E ₉	F ₁₀	G ₁₁	H ₁₂	I ₁₃
5229	5319	5459	5729	6039	6319	6719	7169	8839	9199	9739

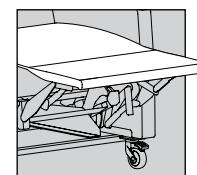

Chaise Models

NOTE: Transfer arm standard on right side (facing). If specified on left side, handle will be placed on right side and vice versa.

Dimensions

E1047 E1147 EC1047 EC1147	Overall			Seat			Back H	Arm H	Kick Out Seat D	Recline D	Distance from Wall
	W	D	H	W	D	H					
R1047 R1147 RC1047 RC1147	33.5	34.5	47.5	24	21	21.5	28.5	28	40	75.5	20
K1047 K1147 KC1047 KC1147	33.5	38.5	47	24	21	21.5	28	28	40	76.5	20

General Info

COM: 7 yds
w/ Chaise COM: 8 yds
Wt Cap: 650 lb
Unit Weight: 166 lb

Available Options

ARM CAP OPTIONS		See pg 2 for finishes	PATIENT WELLNESS & COMFORT OPTIONS		
U	Urethane	Standard	ABP	Adjustable Back Pad (COM 1.75 yds)	
J1	Solid Surface - Group 1	619		Textile Grades COM-B 459	
J2	Solid Surface - Group 2	819		Textile Grades C-I 569	
CASTER OPTIONS			AHP	Adjustable Head Rest Pillow (COM 1 yd) 339	
Q3	3" - Dual Wheel Central Locking System	1019	DP	Dual IV Poles & Brackets ¹ 498	
Q4	4" - Central Lock & Steer System	1019	FBH	Foley Bag Holder 89	
Q5	5" - Central Lock & Steer System	1139	FT	Foot Tray 279	
S4	4" - (2) Caster Lock & Steer System	569	IV	IV Pole & Bracket ¹ 249	
4S3R1	4" - (3) Swivel/(1) Rigid Locking Casters	Standard	LC	LiquiCell 229	
4S4	4" - (4) Swivel Locking Casters	39	LCKFR	Orthopedic Locking Footrest 399	
HEAT/MESSAGE OPTIONS (IEC 60601-1 CERTIFIED)			MBB	Moisture Barrier (Back) 59	
Wand Controls			MBS	Moisture Barrier (Seat) 59	
HW	Heat	1139	MR	Monitor Arm (right side facing) ^{1,2} 849	
HMW	Heat & Massage	1369	MTR	Monitor Arm with Tray (right side facing) ^{1,2} 949	
In-Arm Controls			PR1	Paper Roll Holder ³ 229	
H	Heat	849	TE	Trendelenburg 339	
HM	Heat & Massage	1119	USB	USB Power Outlet (IEC 60601-1 Certified) 459	
ADDITIONAL FEATURES & OPTIONS			WR	Wrist Restraint Mounts (pair) 229	
PB	Push Bar	Standard	TRAY TABLE OPTIONS		
EG	Protective Edge Guard	Standard	TSR1	Adjustable (Right) Side Tray ^{1,2,5} 399	
QR	Additional Quick Release Accessory Bracket	69	TD3	Dual Adjustable Side Trays (TSR1 & TSL1) ^{1,5} 798	
CAL	CAL TB133	See pg 9	*Refer to pg 107 for full option details and images*		
Z	Multi Cover	Use Pricing for Highest Grade			

¹Includes QR bracket connection installed on recliner

²Standard on right side (facing). Replace "R" with "L" for left side (facing) option where available.

³Takes place of Push Bar. Paper sold separately.

⁴Contact customer service for solid surface pricing

⁵Over the lap tray function recommended in seated position.



Select Aesthetic Style (Denotes back & arm design)

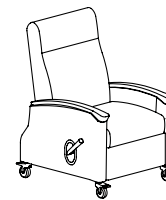

Single Removable Arm

Select Functional Style (Aesthetic style code precedes selected model number below, e.g., KC117)

5047 Mobile Healthcare Recliner - Infinite Position Non-Locking Back - Single Removable Arm

COM	Dillon/Carson	A ₅	B ₆	C ₇	D ₈	E ₉	F ₁₀	G ₁₁	H ₁₂	I ₁₃
4679	4759	4929	5169	5429	5709	6079	6479	7949	8419	8949

5147 Mobile Healthcare Recliner - Infinite Position Locking Back - Single Removable Arm

COM	Dillon/Carson	A ₅	B ₆	C ₇	D ₈	E ₉	F ₁₀	G ₁₁	H ₁₂	I ₁₃
5009	5059	5219	5399	5689	5899	6229	6559	8059	8549	9079

C5047 Mobile Healthcare Chaise Recliner - Infinite Position Non-Locking Back - Single Removable Arm

COM	Dillon/Carson	A ₅	B ₆	C ₇	D ₈	E ₉	F ₁₀	G ₁₁	H ₁₂	I ₁₃
4919	5029	5239	5559	5909	6259	6729	7239	8839	9379	9919

C5147 Mobile Healthcare Chaise Recliner - Infinite Position Locking Back - Single Removable Arm

COM	Dillon/Carson	A ₅	B ₆	C ₇	D ₈	E ₉	F ₁₀	G ₁₁	H ₁₂	I ₁₃
5249	5339	5519	5789	6169	6459	6859	7329	8939	9389	9899

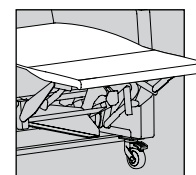

Chaise Models

NOTE: Transfer arm standard on right side (facing). If specified on left side, handle will be placed on right side and vice versa.

Dimensions

H5047 H5147 HC5047 HC5147	Overall			Seat			Back H	Arm H	Kick Out Seat D	Recline D	Distance from Wall
	W	D	H	W	D	H					
	34	38	47	24	21	21.5	26	28	40	76	20

General Info

COM: 7 yds
w/ Chaise COM: 8 yds
Wt Cap: 650 lb
Unit Weight: 175 lb

Available Options

ARM CAP OPTIONS

See pg 2 for finishes

U	Urethane (black only in Harmony style)	Standard
---	--	----------

CASTER OPTIONS

S4	4" - (2) Caster Lock & Steer System	569
4S3R1	4" - (3) Swivel/(1) Rigid Locking Casters	Standard
4S4	4" - (4) Swivel Locking Casters	39

HEAT/MASSAGE OPTIONS (IEC 60601-1 CERTIFIED)

Wand Controls

HW	Heat	1139
HMW	Heat & Massage	1369

In-Arm Controls

H	Heat	849
HM	Heat & Massage	1119

ADDITIONAL FEATURES & OPTIONS

PB	Push Bar	Standard
EG	Protective Edge Guard	Standard
QR	Additional Quick Release Accessory Bracket	69
CAL	CAL TB133	See pg 9
Z	Multi Cover	Use Pricing for Highest Grade

PATIENT WELLNESS & COMFORT OPTIONS

ABP	Adjustable Back Pad (COM 1.75 yds)	
	Textile Grades COM-B	459
	Textile Grades C-I	569
AHP	Adjustable Head Rest Pillow (COM 1 yd)	339
DP	Dual IV Poles & Brackets ¹	498
FBH	Foley Bag Holder	89
FT	Foot Tray	279
IV	IV Pole & Bracket ¹	249
LC	LiquiCell	229
LCKFR	Orthopedic Locking Footrest	399
MBB	Moisture Barrier (Back)	59
MBS	Moisture Barrier (Seat)	59
MR	Monitor Arm (right side facing) ^{1,2}	849
MTR	Monitor Arm with Tray (right side facing) ^{1,2}	949
PR1	Paper Roll Holder ³	229
TE	Trendelenburg	339
USB	USB Power Outlet (IEC 60601-1 Certified)	459
WR	Wrist Restraint Mounts (pair)	229

TRAY TABLE OPTIONS

TSR1	Adjustable (Right) Side Tray ^{1,2,5}	399
TD3	Dual Adjustable Side Trays (TSR1 & TSL1) ^{1,5}	798

Refer to pg 107 for full option details and images

¹Includes QR bracket connection installed on recliner

²Standard on right side (facing). Replace "R" with "L" for left side (facing) option where available.

³Takes place of Push Bar. Paper sold separately.

⁴Contact customer service for solid surface pricing

⁵Over the lap tray function recommended in seated position.



DURABLE® 650 SERIES

Mobile Healthcare Recliners | Patient Transfer

Select Aesthetic Style (Denotes back & arm design)

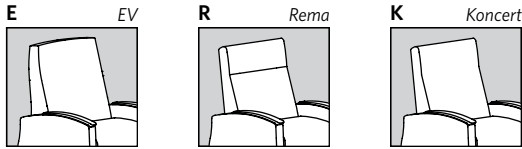

Dual Removable Arms
(Koncert style pictured)

Select Functional Style (Aesthetic style code precedes selected model number below, e.g., KC1117)

1042 Mobile Healthcare Recliner - Infinite Position Non-Locking Back - Dual Removable Arms

COM	Dillon	Carson	A ₅	B ₆	C ₇	D ₈	E ₉	F ₁₀	G ₁₁	H ₁₂	I ₁₃
5419	5479	5549	5739	5989	6179	6479	6789	8159	8549	9079	

1142 Mobile Healthcare Recliner - Infinite Position Locking Back - Dual Removable Arms

COM	Dillon	Carson	A ₅	B ₆	C ₇	D ₈	E ₉	F ₁₀	G ₁₁	H ₁₂	I ₁₃
6089	6139	6219	6389	6639	6789	7099	7429	8759	8949	9339	

C1042 Mobile Healthcare Chaise Recliner - Infinite Position Non-Locking Back - Dual Removable Arms

COM	Dillon	Carson	A ₅	B ₆	C ₇	D ₈	E ₉	F ₁₀	G ₁₁	H ₁₂	I ₁₃
5619	5709	5829	6059	6419	6669	7029	7469	8949	9469	10129	

C1142 Mobile Healthcare Chaise Recliner - Infinite Position Locking Back - Dual Removable Arms

COM	Dillon	Carson	A ₅	B ₆	C ₇	D ₈	E ₉	F ₁₀	G ₁₁	H ₁₂	I ₁₃
6289	6359	6489	6719	7039	7289	7689	8099	9559	10129	10529	

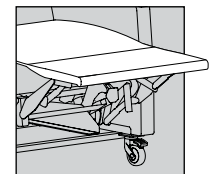

Chaise Models

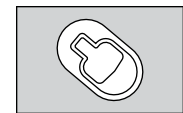

Locking Back Lever
(located on outside arm on applicable models)

Dimensions

E1042 E1142 EC1042 EC1142	Overall			Seat			Back H	Arm H	Kick Out Seat D	Recline D	Distance from Wall
	W	D	H	W	D	H					
R1042 R1142 RC1042 RC1142	33.5	34.5	47.5	24	21	21.5	28.5	28	40	75.5	20
K1042 K1142 KC1042 KC1142	33.5	38.5	47	24	21	21.5	28	28	40	76.5	20

General Info

COM: 7 yds
w/ Chaise COM: 8 yds
Wt Cap: 650 lb
Unit Weight: 166 lb

Available Options

ARM CAP OPTIONS

See pg 2 for finishes

U	Urethane	Standard
J1	Solid Surface - Group 1	619
J2	Solid Surface - Group 2	819

CASTER OPTIONS

Q3	3" - Dual Wheel Central Locking System	1019
Q4	4" - Central Lock & Steer System	1019
Q5	5" - Central Lock & Steer System	1139
S4	4" - (2) Caster Lock & Steer System	569
4S3R1	4" - (3) Swivel/(1) Rigid Locking Casters	Standard
4S4	4" - (4) Swivel Locking Casters	39

HEAT/MASSAGE OPTIONS (IEC 60601-1 CERTIFIED)

Wand Controls

HW	Heat	1139
HMW	Heat & Massage	1369

ADDITIONAL FEATURES & OPTIONS

PB	Push Bar	Standard
EG	Protective Edge Guard	Standard
QR	Additional Quick Release Accessory Bracket	69
CAL	CAL TB133	See pg 9
Z	Multi Cover	Use Pricing for Highest Grade

PATIENT WELLNESS & COMFORT OPTIONS

ABP	Adjustable Back Pad (COM 1.75 yds)	
	Textile Grades COM-B	459
	Textile Grades C-I	569
AHP	Adjustable Head Rest Pillow (COM 1 yd)	339
DP	Dual IV Poles & Brackets ¹	498
FBH	Foley Bag Holder	89
FT	Foot Tray	279
IV	IV Pole & Bracket ¹	249
LC	LiquiCell	229
LCKFR	Orthopedic Locking Footrest	399
MBB	Moisture Barrier (Back)	59
MBS	Moisture Barrier (Seat)	59
MR	Monitor Arm (right side facing) ^{1,2}	849
MTR	Monitor Arm with Tray (right side facing) ^{1,2}	949
PR1	Paper Roll Holder ³	229
TE	Trendelenburg	339
USB	USB Power Outlet (IEC 60601-1 Certified)	459
WR	Wrist Restraint Mounts (pair)	229

TRAY TABLE OPTIONS

TSR1	Adjustable (Right) Side Tray ^{1,2,5}	399
TD3	Dual Adjustable Side Trays (TSR1 & TSL1) ^{1,5}	798

Refer to pg 107 for full option details and images

¹Includes QR bracket connection installed on recliner

²Standard on right side (facing). Replace "R" with "L" for left side (facing) option where available.

³Takes place of Push Bar. Paper sold separately.

⁴Contact customer service for solid surface pricing

⁵Over the lap tray function recommended in seated position.

DURABLE® 750 SERIES



Series Overview

The bariatric sibling of the Durable® 650 Series, the Durable® 750 Series delivers the same comfort, performance, and durability, along with a wider 29" seat width and 750 lb weight rating. Featuring the patented Durable® unitized mechanism for smooth, full-body motion and near limitless option configurations, the Durable® 750 Series ensures that all patients have access to a comfortable and safe seating space.

General Product Information

- 750 lb Weight Rating
- Designed for 24/7 use healthcare environments
- Seat width 29"
- Manually operated recline functionality
- Footrest and back move in harmony when engaged
- Quick removable back & lift up seat for ease of cleaning
- True flatbed sleep position
- Sinuous spring seat and back
- Seat clean-out
- Mid-Ottoman Calf Support
- Infinite Position Back reclines to infinite angle positions
- All interior plywood California Carb Compliant/Phase II
- Field replaceable components

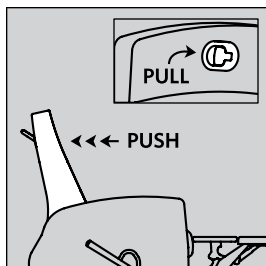

Infinite Position Locking Back

Allows patient/caregiver to lock back into any position. Lock lever located inside left (facing) arm on applicable models, unless otherwise noted/pictured.

To Order, Specify

- Model Number
- Textile
- Finish
- Options

Options vary by model, see specific model page for list of available options

Refer to pg 107 for full option details and images

DURABLE® 750 SERIES

Bariatric Mobile Healthcare Recliners

Select Aesthetic Style (Denotes back & arm design)

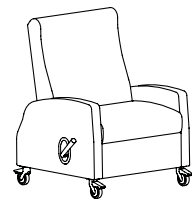
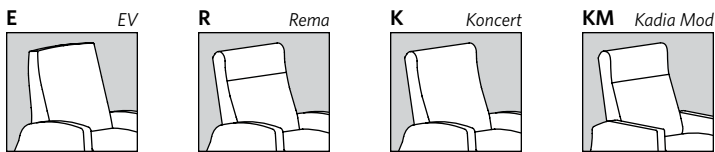

(Koncert style pictured)

Select Functional Style (Aesthetic style code precedes selected model number below, e.g., KBC1117)

B1037 Bariatric Mobile Healthcare Recliner - Infinite Position Non-Locking Back

COM	Dillon/Carson	A ₅	B ₆	C ₇	D ₈	E ₉	F ₁₀	G ₁₁	H ₁₂	I ₁₃
4579	4639	4829	5059	5379	5669	6069	6509	8309	8899	9599

B1137 Bariatric Mobile Healthcare Recliner - Infinite Position Locking Back

COM	Dillon/Carson	A ₅	B ₆	C ₇	D ₈	E ₉	F ₁₀	G ₁₁	H ₁₂	I ₁₃
4979	5069	5249	5469	5789	6079	6469	6889	8689	9369	9949

BC1037 Bariatric Mobile Healthcare Chaise Recliner - Infinite Position Non-Locking Back

COM	Dillon/Carson	A ₅	B ₆	C ₇	D ₈	E ₉	F ₁₀	G ₁₁	H ₁₂	I ₁₃
4779	4899	5099	5419	5819	6189	6669	7219	9319	9739	10399

BC1137 Bariatric Mobile Healthcare Chaise Recliner - Infinite Position Locking Back

COM	Dillon/Carson	A ₅	B ₆	C ₇	D ₈	E ₉	F ₁₀	G ₁₁	H ₁₂	I ₁₃
5189	5319	5519	5829	6239	6589	7069	7599	9699	10269	10919

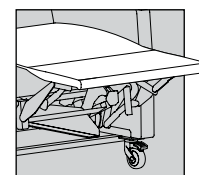

Chaise Models

Dimensions

	Overall			Seat			Back H	Arm H	Kick Out Seat D	Recline D	Distance from Wall
	W	D	H	W	D	H					
EB1037 EB1137 EBC1037 EBC1137	38	34.5	47.5	29	21	21.5	28.5	28	40	75.5	20
RB1037 RB1137 RBC1037 RBC1137 KB1037 KB1137 KBC1037 KBC1137	38	38.5	47	29	21	21.5	28	28	40	76.5	20
KMB1037 KMB1137 KMBC1037 KMBC1137	38	38.5	47	29	21	21.5	28	26.5	40	76.5	20

General Info

COM: 7 yds
w/ Chaise COM: 8 yds
Wt Cap: 750 lb
Unit Weight: 162 lb

Available Options

ARM CAP OPTIONS

See pg 2 for finishes

U	Urethane	169
J1	Solid Surface - Group 1	619
J2	Solid Surface - Group 2	819
F	Fully Upholstered Arms	Standard

CASTER OPTIONS

Q3	3" - Dual Wheel Central Locking System	1019
Q4	4" - Central Lock & Steer System	1019
Q5	5" - Central Lock & Steer System	1139
S4	4" - (2) Caster Lock & Steer System	569
4S3R1	4" - (3) Swivel/(1) Rigid Locking Casters	Standard
4S4	4" - (4) Swivel Locking Casters	39

HEAT/MASSAGE OPTIONS (IEC 60601-1 CERTIFIED)

Wand Controls

HW	Heat	1139
HMW	Heat & Massage	1369

In-Arm Controls

H	Heat	849
HM	Heat & Massage	1119

ADDITIONAL FEATURES & OPTIONS

PB	Push Bar	Standard
EG	Protective Edge Guard	Standard
QR	Additional Quick Release Accessory Bracket	69
CAL	CAL TB133	See pg 9
Z	Multi Cover	Use Pricing for Highest Grade

PATIENT WELLNESS & COMFORT OPTIONS

AHP	Adjustable Head Rest Pillow (COM 1 yd)	339
DP	Dual IV Poles & Brackets ¹	498
FBH	Foley Bag Holder	89
FT	Foot Tray	279
IV	IV Pole & Bracket ¹	249
LC	LiquiCell	229
LCKFR	Orthopedic Locking Footrest	399
MBB	Moisture Barrier (Back)	89
MBS	Moisture Barrier (Seat)	89
MR	Monitor Arm (right side facing) ^{1,2}	849
MTR	Monitor Arm with Tray (right side facing) ^{1,2}	949
PR1	Paper Roll Holder ³	229
TE750	Trendelenburg (Bariatric)	459
USB	USB Power Outlet (IEC 60601-1 Certified)	459
WR	Wrist Restraint Mounts (pair)	229

TRAY TABLE OPTIONS

TSR1	Adjustable (Right) Side Tray ^{1,2,5}	399
TD3	Dual Adjustable Side Trays (TSR1 & TSL1) ^{1,5}	798
LFSTR	Large Folding (Right) Side Tray ⁴	249
LFSTRCH	Large Folding Cup Holder (Right) Side Tray	319
PLFSTR	Padded Large Folding (Right) Side Tray	379
SFSTR	Small Folding (Right) Side Tray ⁴	249

Refer to pg 107 for full option details and images

¹Includes QR bracket connection installed on recliner

²Standard on right side (facing). Replace "R" with "L" for left side (facing) option where available.

³Takes place of Push Bar. Paper sold separately.

⁴Contact customer service for solid surface pricing

⁵Over the lap tray function recommended in seated position.



DURABLE® 750 SERIES

Bariatric Mobile Healthcare Recliners

Select Aesthetic Style (Denotes back & arm design)

E EV-Narrow Arm

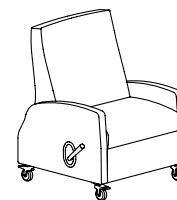
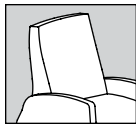

Select Functional Style (Aesthetic style code precedes selected model number below, e.g., KBC1117)

B4037 Bariatric Mobile Healthcare Recliner - Narrow Arms - Infinite Position Non-Locking Back

COM	Dillon/Carson	A ₅	B ₆	C ₇	D ₈	E ₉	F ₁₀	G ₁₁	H ₁₂	I ₁₃
4479	4589	4749	5009	5309	5619	6009	6439	8249	8899	9479

B4137 Bariatric Mobile Healthcare Recliner - Narrow Arms - Infinite Position Locking Back

COM	Dillon/Carson	A ₅	B ₆	C ₇	D ₈	E ₉	F ₁₀	G ₁₁	H ₁₂	I ₁₃
4899	5009	5139	5399	5719	6019	6389	6839	8629	9199	9729

BC4037 Bariatric Mobile Healthcare Chaise Recliner - Narrow Arms - Infinite Position Non-Locking Back

COM	Dillon/Carson	A ₅	B ₆	C ₇	D ₈	E ₉	F ₁₀	G ₁₁	H ₁₂	I ₁₃
4689	4829	5049	5369	5759	6129	6599	7149	9249	9729	10399

BC4137 Bariatric Mobile Healthcare Chaise Recliner - Narrow Arms - Infinite Position Locking Back

COM	Dillon/Carson	A ₅	B ₆	C ₇	D ₈	E ₉	F ₁₀	G ₁₁	H ₁₂	I ₁₃
5129	5249	5459	5769	6169	6529	6999	7549	9639	10259	10789

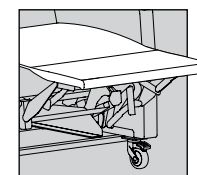

Chaise Models

Dimensions

EB4037 EB4137 EBC4037 EBC4137	Overall			Seat			Back H	Arm H	Kick Out Seat D	Recline D	Distance from Wall
	W	D	H	W	D	H					
	37	34.5	47.5	29	21	21.5	28.5	28	40	75.5	20

General Info

COM: 7 yds
w/ Chaise COM: 8 yds
Wt Cap: 750 lb
Unit Weight: 162 lb

Available Options

ARM CAP OPTIONS

See pg 2 for finishes

U	Urethane	169
J1	Solid Surface - Group 1	619
J2	Solid Surface - Group 2	819
F	Fully Upholstered Arms	Standard

CASTER OPTIONS

Q3	3" - Dual Wheel Central Locking System	1019
Q4	4" - Central Lock & Steer System	1019
Q5	5" - Central Lock & Steer System	1139
S4	4" - (2) Caster Lock & Steer System	569
4S3R1	4" - (3) Swivel/(1) Rigid Locking Casters	Standard
4S4	4" - (4) Swivel Locking Casters	39

HEAT/MASSAGE OPTIONS (IEC 60601-1 CERTIFIED)

Wand Controls

HW	Heat	1139
HMW	Heat & Massage	1369

In-Arm Controls

H	Heat	849
HM	Heat & Massage	1119

ADDITIONAL FEATURES & OPTIONS

PB	Push Bar	Standard
EG	Protective Edge Guard	Standard
QR	Additional Quick Release Accessory Bracket	69
CAL	CAL TB133	See pg 9
Z	Multi Cover	Use Pricing for Highest Grade

PATIENT WELLNESS & COMFORT OPTIONS

AHP	Adjustable Head Rest Pillow (COM 1yd)	339
DP	Dual IV Poles & Brackets ¹	498
FBH	Foley Bag Holder	89
FT	Foot Tray	279
IV	IV Pole & Bracket ¹	249
LC	LiquiCell	229
LCKFR	Orthopedic Locking Footrest	399
MBB	Moisture Barrier (Back)	89
MBS	Moisture Barrier (Seat)	89
MR	Monitor Arm (right side facing) ^{1,2}	849
MTR	Monitor Arm with Tray (right side facing) ^{1,2}	949
PR1	Paper Roll Holder ³	229
TE750	Trendelenburg (Bariatric)	459
USB	USB Power Outlet (IEC 60601-1 Certified)	459
WR	Wrist Restraint Mounts (pair)	229

TRAY TABLE OPTIONS

TSR1	Adjustable (Right) Side Tray ^{1,2,5}	399
TD3	Dual Adjustable Side Trays (TSR1 & TSL1) ^{1,5}	798
LFSTR	Large Folding (Right) Side Tray ⁴	249
LFSTRCH	Large Folding Cup Holder (Right) Side Tray	319
PLFSTR	Padded Large Folding (Right) Side Tray	379
SFSTR	Small Folding (Right) Side Tray ⁴	249

Refer to pg 107 for full option details and images

¹Includes QR bracket connection installed on recliner

²Standard on right side (facing). Replace "R" with "L" for left side (facing) option where available.

³Takes place of Push Bar. Paper sold separately.

⁴Contact customer service for solid surface pricing

⁵Over the lap tray function recommended in seated position.



DURABLE® 750 SERIES

Bariatric Mobile Healthcare Recliners

Select Aesthetic Style (Denotes back & arm design)

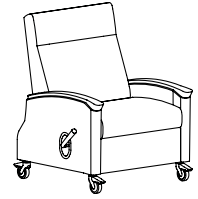
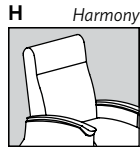

Select Functional Style (Aesthetic style code precedes selected model number below, e.g., KBC1117)

5037 Bariatric Mobile Healthcare Recliner - Infinite Position Non-Locking Back

COM	Dillon/Carson	A ₅	B ₆	C ₇	D ₈	E ₉	F ₁₀	G ₁₁	H ₁₂	I ₁₃
4779	4849	5039	5279	5579	5869	6269	6689	8499	9079	9599

5137 Bariatric Mobile Healthcare Recliner - Infinite Position Locking Back

COM	Dillon/Carson	A ₅	B ₆	C ₇	D ₈	E ₉	F ₁₀	G ₁₁	H ₁₂	I ₁₃
5189	5269	5449	5689	5999	6269	6669	7089	8869	9479	9999

C5037 Bariatric Mobile Healthcare Chaise Recliner - Infinite Position Non-Locking Back

COM	Dillon/Carson	A ₅	B ₆	C ₇	D ₈	E ₉	F ₁₀	G ₁₁	H ₁₂	I ₁₃
5019	5119	5339	5669	6059	6439	6909	7469	9409	9949	10469

C5137 Bariatric Mobile Healthcare Chaise Recliner - Infinite Position Locking Back

COM	Dillon/Carson	A ₅	B ₆	C ₇	D ₈	E ₉	F ₁₀	G ₁₁	H ₁₂	I ₁₃
5429	5539	5759	6089	6479	6819	7309	7849	9759	10259	11049

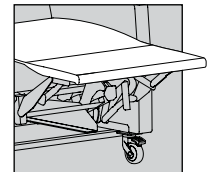

Chaise Models

Dimensions

H5037 H5137 HC5037 HC5137	Overall			Seat			Back H	Arm H	Kick Out Seat D	Recline D	Distance from Wall
	W	D	H	W	D	H					
	39	38	47	29	21	21.5	26	28	40	73	20

General Info

COM: 7 yds
w/ Chaise COM: 8 yds
Wt Cap: 750 lb
Unit Weight: 162 lb

Available Options

ARM CAP OPTIONS

See pg 2 for finishes

U	Urethane (black only in Harmony style)	Standard
---	--	----------

CASTER OPTIONS

S4	4" - (2) Caster Lock & Steer System	569
4S3R1	4" - (3) Swivel/(1) Rigid Locking Casters	Standard
4S4	4" - (4) Swivel Locking Casters	39

HEAT/MASSAGE OPTIONS (IEC 60601-1 CERTIFIED)

Wand Controls

HW	Heat	1139
HMW	Heat & Massage	1369

In-Arm Controls

H	Heat	849
HM	Heat & Massage	1119

ADDITIONAL FEATURES & OPTIONS

PB	Push Bar	Standard
EG	Protective Edge Guard	Standard
QR	Additional Quick Release Accessory Bracket	69
CAL	CAL TB133	See pg 9
Z	Multi Cover	Use Pricing for Highest Grade

PATIENT WELLNESS & COMFORT OPTIONS

AHP	Adjustable Head Rest Pillow (COM 1 yd)	339
DP	Dual IV Poles & Brackets ¹	498
FBH	Foley Bag Holder	89
FT	Foot Tray	279
IV	IV Pole & Bracket ¹	249
LC	LiquiCell	229
LCKFR	Orthopedic Locking Footrest	399
MBB	Moisture Barrier (Back)	89
MBS	Moisture Barrier (Seat)	89
MR	Monitor Arm (right side facing) ^{1,2}	849
MTR	Monitor Arm with Tray (right side facing) ^{1,2}	949
PR1	Paper Roll Holder ³	229
TE750	Trendelenburg (Bariatric)	459
USB	USB Power Outlet (IEC 60601-1 Certified)	459
WR	Wrist Restraint Mounts (pair)	229

TRAY TABLE OPTIONS

TSR1	Adjustable (Right) Side Tray ^{1,2,5}	399
TD3	Dual Adjustable Side Trays (TSR1 & TSL1) ^{1,5}	798
LFSTR	Large Folding (Right) Side Tray ⁴	249
LFSTRCH	Large Folding Cup Holder (Right) Side Tray	319
PLFSTR	Padded Large Folding (Right) Side Tray	379
SFSTR	Small Folding (Right) Side Tray ⁴	249

Refer to pg 107 for full option details and images

¹Includes QR bracket connection installed on recliner

²Standard on right side (facing). Replace "R" with "L" for left side (facing) option where available.

³Takes place of Push Bar. Paper sold separately.

⁴Contact customer service for solid surface pricing

⁵Over the lap tray function recommended in seated position.



Select Aesthetic Style (Denotes back & arm design)

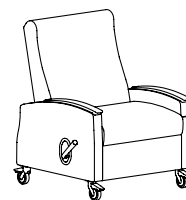
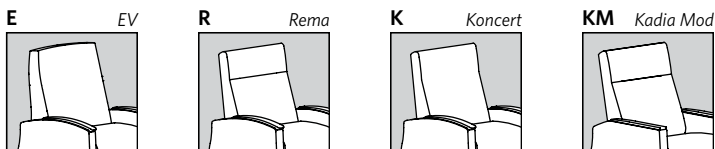

Single Fold Down Arm
(Koncert style pictured)

Select Functional Style (Aesthetic style code precedes selected model number below, e.g., KC1117)

B1067 Bariatric Mobile Healthcare Recliner - Infinite Position Non-Locking Back - Single Fold Down Arm

COM	Dillon/Carson	A ₅	B ₆	C ₇	D ₈	E ₉	F ₁₀	G ₁₁	H ₁₂	I ₁₃
5499	5559	5739	5949	6279	6559	6959	7359	9129	9599	10259

B1167 Bariatric Mobile Healthcare Recliner - Infinite Position Locking Back - Single Fold Down Arm

COM	Dillon/Carson	A ₅	B ₆	C ₇	D ₈	E ₉	F ₁₀	G ₁₁	H ₁₂	I ₁₃
5929	5959	6129	6339	6689	6959	7349	7759	9499	9999	10659

BC1067 Bariatric Mobile Healthcare Chaise Recliner - Infinite Position Non-Locking Back - Single Fold Down Arm

COM	Dillon/Carson	A ₅	B ₆	C ₇	D ₈	E ₉	F ₁₀	G ₁₁	H ₁₂	I ₁₃
5699	5819	6019	6309	6729	7069	7549	8079	10149	10529	11159

BC1167 Bariatric Mobile Healthcare Chaise Recliner - Infinite Position Locking Back - Single Fold Down Arm

COM	Dillon/Carson	A ₅	B ₆	C ₇	D ₈	E ₉	F ₁₀	G ₁₁	H ₁₂	I ₁₃
6109	6239	6419	6729	7109	7469	7959	8459	10509	11049	11579

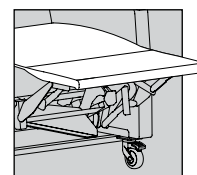

Chaise Models

NOTE: Transfer arm standard on right side (facing). If specified on left side, handle will be placed on right side and vice versa.

Dimensions

	Overall			Seat			Back H	Arm H	Kick Out Seat D	Recline D	Distance from Wall
	W	D	H	W	D	H					
EB1067 EB1167 EBC1067 EBC1167	38	34.5	47.5	29	21	21.5	28.5	27	40	75.5	20
RB1067 RB1167 RBC1067 RBC1167 KB1067 KB1167 KBC1067 KBC1167	38	38.5	47	29	21	21.5	28	27	40	76.5	20
KMB1067 KMB1167 KMBC1067 KMBC1167	38	38.5	47	29	21	21.5	28	26.5	40	76.5	20

General Info

COM: 8 yds
w/ Chaise COM: 9 yds
Wt Cap: 750 lb
Unit Weight: 162 lb

Available Options

ARM CAP OPTIONS

See pg 2 for finishes

U	Urethane	Standard
J1	Solid Surface - Group 1	619
J2	Solid Surface - Group 2	819

CASTER OPTIONS

Q3	3" - Dual Wheel Central Locking System	1019
Q4	4" - Central Lock & Steer System	1019
Q5	5" - Central Lock & Steer System	1139
S4	4" - (2) Caster Lock & Steer System	569
4S3R1	4" - (3) Swivel/(1) Rigid Locking Casters	Standard
4S4	4" - (4) Swivel Locking Casters	39

HEAT/MASSAGE OPTIONS (IEC 60601-1 CERTIFIED)

Wand Controls

HW	Heat	1139
HMW	Heat & Massage	1369

In-Arm Controls

H	Heat	849
HM	Heat & Massage	1119

ADDITIONAL FEATURES & OPTIONS

PB	Push Bar	Standard
EG	Protective Edge Guard	Standard
QR	Additional Quick Release Accessory Bracket	69
CAL	CAL TB133	See pg 9
Z	Multi Cover	Use Pricing for Highest Grade

PATIENT WELLNESS & COMFORT OPTIONS

AHP	Adjustable Head Rest Pillow (COM 1 yd)	339
DP	Dual IV Poles & Brackets ¹	498
FBH	Foley Bag Holder	89
FT	Foot Tray	279
IV	IV Pole & Bracket ¹	249
LC	LiquiCell	229
LCKFR	Orthopedic Locking Footrest	399
MBB	Moisture Barrier (Back)	89
MBS	Moisture Barrier (Seat)	89
MR	Monitor Arm (right side facing) ^{1,2}	849
MTR	Monitor Arm with Tray (right side facing) ^{1,2}	949
PR1	Paper Roll Holder ³	229
TE750	Trendelenburg (Bariatric)	459
USB	USB Power Outlet (IEC 60601-1 Certified)	459
WR	Wrist Restraint Mounts (pair)	229

TRAY TABLE OPTIONS

TSL1	Adjustable (Left) Side Tray, on Stationary Arm ^{1,5}	399
TSR167	Adjustable (Right) Side Tray, on Fold Down Arm ^{1,5}	449

FOLD DOWN TRANSFER ARM SPECIFIC

HC	Hinge Cover	Standard
----	-------------	----------

Refer to pg 107 for full option details and images

¹Includes QR bracket connection installed on recliner

²Standard on right side (facing). Replace "R" with "L" for left side (facing) option where available.

³Takes place of Push Bar. Paper sold separately.

⁴Contact customer service for solid surface pricing

⁵Over the lap tray function recommended in seated position.



Select Aesthetic Style (Denotes back & arm design)

E EV-Narrow Arm

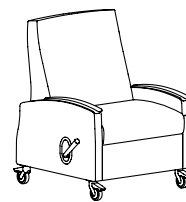
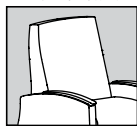

Single Fold Down Arm

Select Functional Style (Aesthetic style code precedes selected model number below, e.g., KC117)

B4067 Bari. Mobile Healthcare Recliner - Narrow Arms - Inf. Position Non-Locking Back - Single Fold Down Arm

COM	Dillon/Carson	A ₅	B ₆	C ₇	D ₈	E ₉	F ₁₀	G ₁₁	H ₁₂	I ₁₃
5639	5699	5859	6089	6419	6679	7079	7519	9259	9739	10399

B4167 Bari. Mobile Healthcare Recliner - Narrow Arms - Inf. Position Locking Back - Single Fold Down Arm

COM	Dillon/Carson	A ₅	B ₆	C ₇	D ₈	E ₉	F ₁₀	G ₁₁	H ₁₂	I ₁₃
6059	6109	6279	6499	6799	7079	7479	7899	9649	10129	10739

BC4067 Bari. Mobile Healthcare Chaise Recliner - Narrow Arms - Inf. Position Non-Locking Back - Single Fold Down Arm

COM	Dillon/Carson	A ₅	B ₆	C ₇	D ₈	E ₉	F ₁₀	G ₁₁	H ₁₂	I ₁₃
5829	5949	6149	6469	6849	7199	7679	8219	10269	10789	11449

BC4167 Bari. Mobile Healthcare Chaise Recliner - Narrow Arms - Inf. Position Locking Back - Single Fold Down Arm

COM	Dillon/Carson	A ₅	B ₆	C ₇	D ₈	E ₉	F ₁₀	G ₁₁	H ₁₂	I ₁₃
6259	6369	6569	6849	7269	7589	8069	8619	10659	11049	11579

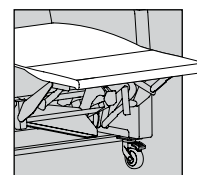

Chaise Models

NOTE: Transfer arm standard on right side (facing). If specified on left side, handle will be placed on right side and vice versa.

Dimensions

EB4067 EB4167 EBC4067 EBC4167	Overall			Seat			Back H	Arm H	Kick Out Seat D	Recline D	Distance from Wall
	W	D	H	W	D	H					
	37	34.5	47.5	29	21	21.5	28.5	27	40	75.5	20

General Info

COM: 8 yds
w/ Chaise COM: 9 yds
Wt Cap: 750 lb
Unit Weight: 162 lb

Available Options

ARM CAP OPTIONS

See pg 2 for finishes

U	Urethane	Standard
J1	Solid Surface - Group 1	619
J2	Solid Surface - Group 2	819

CASTER OPTIONS

Q3	3" - Dual Wheel Central Locking System	1019
Q4	4" - Central Lock & Steer System	1019
Q5	5" - Central Lock & Steer System	1139
S4	4" - (2) Caster Lock & Steer System	569
4S3R1	4" - (3) Swivel/(1) Rigid Locking Casters	Standard
4S4	4" - (4) Swivel Locking Casters	39

HEAT/MASSAGE OPTIONS (IEC 60601-1 CERTIFIED)

Wand Controls

HW	Heat	1139
HMW	Heat & Massage	1369

In-Arm Controls

H	Heat	849
HM	Heat & Massage	1119

ADDITIONAL FEATURES & OPTIONS

PB	Push Bar	Standard
EG	Protective Edge Guard	Standard
QR	Additional Quick Release Accessory Bracket	69
CAL	CAL TB133	See pg 9
Z	Multi Cover	Use Pricing for Highest Grade

PATIENT WELLNESS & COMFORT OPTIONS

AHP	Adjustable Head Rest Pillow (COM 1 yd)	339
DP	Dual IV Poles & Brackets ¹	498
FBH	Foley Bag Holder	89
FT	Foot Tray	279
IV	IV Pole & Bracket ¹	249
LC	LiquiCell	229
LCKFR	Orthopedic Locking Footrest	399
MBB	Moisture Barrier (Back)	89
MBS	Moisture Barrier (Seat)	89
MR	Monitor Arm (right side facing) ^{1,2}	849
MTR	Monitor Arm with Tray (right side facing) ^{1,2}	949
PR1	Paper Roll Holder ³	229
TE750	Trendelenburg (Bariatric)	459
USB	USB Power Outlet (IEC 60601-1 Certified)	459
WR	Wrist Restraint Mounts (pair)	229

TRAY TABLE OPTIONS

TSL1	Adjustable (Left) Side Tray, on Stationary Arm ^{1,5}	399
TSR167	Adjustable (Right) Side Tray, on Fold Down Arm ^{1,5}	449

FOLD DOWN TRANSFER ARM SPECIFIC

HC	Hinge Cover	Standard
----	-------------	----------

Refer to pg 107 for full option details and images

¹Includes QR bracket connection installed on recliner

²Standard on right side (facing). Replace "R" with "L" for left side (facing) option where available.

³Takes place of Push Bar. Paper sold separately.

⁴Contact customer service for solid surface pricing

⁵Over the lap tray function recommended in seated position.



DURABLE® 750 SERIES

Bariatric Mobile Healthcare Recliners | Patient Transfer

Select Aesthetic Style (Denotes back & arm design)

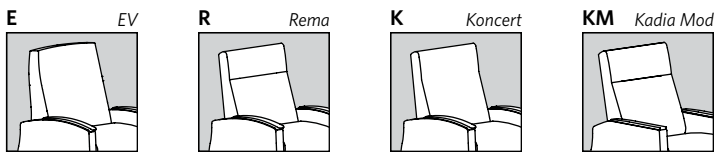

Dual Fold Down Arms
(Koncert style pictured)

Select Functional Style (Aesthetic style code precedes selected model number below, e.g., KC117)

B1062 Bariatric Mobile Healthcare Recliner - Infinite Position Non-Locking Back - Dual Fold Down Arms

COM	Dillon/Carson	A ₅	B ₆	C ₇	D ₈	E ₉	F ₁₀	G ₁₁	H ₁₂	I ₁₃
6419	6479	6649	6839	7179	7449	7849	8209	9949	10299	10919

B1162 Bariatric Mobile Healthcare Recliner - Infinite Position Locking Back - Dual Fold Down Arms

COM	Dillon/Carson	A ₅	B ₆	C ₇	D ₈	E ₉	F ₁₀	G ₁₁	H ₁₂	I ₁₃
6849	6879	7009	7209	7589	7839	8229	8629	10309	10629	11369

BC1062 Bariatric Mobile Healthcare Chaise Recliner - Infinite Position Non-Locking Back - Dual Fold Down Arms

COM	Dillon/Carson	A ₅	B ₆	C ₇	D ₈	E ₉	F ₁₀	G ₁₁	H ₁₂	I ₁₃
6619	6739	6939	7199	7639	7949	8429	8939	10979	11319	11919

BC1162 Bariatric Mobile Healthcare Chaise Recliner - Infinite Position Locking Back - Dual Fold Down Arms

COM	Dillon/Carson	A ₅	B ₆	C ₇	D ₈	E ₉	F ₁₀	G ₁₁	H ₁₂	I ₁₃
7029	7159	7319	7629	7979	8349	8849	9319	11319	11829	12239

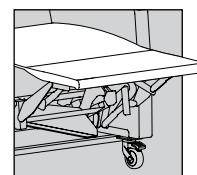

Chaise Models

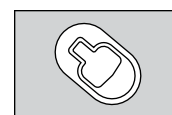

Locking Back Lever
(located on outside arm on applicable models)

Dimensions

	Overall			Seat			Back H	Arm H	Kick Out Seat D	Recline D	Distance from Wall
	W	D	H	W	D	H					
EB1062 EB1162 EBC1062 EBC1162	38	34.5	47.5	29	21	21.5	28.5	27	40	75.5	20
RB1062 RB1162 RBC1062 RBC1162	38	38.5	47	29	21	21.5	28	27	40	76.5	20
KB1062 KB1162 KBC1062 KBC1162	38	38.5	47	29	21	21.5	28	26.5	40	76.5	20
KMB1062 KMB1162 KMBC1062 KMBC1162	38	38.5	47	29	21	21.5	28	26.5	40	76.5	20

General Info

COM: 8 yds
w/ Chaise COM: 9 yds
Wt Cap: 750 lb
Unit Weight: 162 lb

Available Options

ARM CAP OPTIONS

See pg 2 for finishes

U	Urethane	Standard
J1	Solid Surface - Group 1	619
J2	Solid Surface - Group 2	819

CASTER OPTIONS

Q3	3" - Dual Wheel Central Locking System	1019
Q4	4" - Central Lock & Steer System	1019
Q5	5" - Central Lock & Steer System	1139
S4	4" - (2) Caster Lock & Steer System	569
453R1	4" - (3) Swivel/(1) Rigid Locking Casters	Standard
4S4	4" - (4) Swivel Locking Casters	39

HEAT/MASSAGE OPTIONS (IEC 60601-1 CERTIFIED)

Wand Controls

HW	Heat	1139
HMW	Heat & Massage	1369

ADDITIONAL FEATURES & OPTIONS

PB	Push Bar	Standard
EG	Protective Edge Guard	Standard
QR	Additional Quick Release Accessory Bracket	69
CAL	CAL TB133	See pg 9
Z	Multi Cover	Use Pricing for Highest Grade

PATIENT WELLNESS & COMFORT OPTIONS

AHP	Adjustable Head Rest Pillow (COM 1 yd)	339
DP	Dual IV Poles & Brackets ¹	498
FBH	Foley Bag Holder	89
FT	Foot Tray	279
IV	IV Pole & Bracket ¹	249
LC	LiquiCell	229
LCKFR	Orthopedic Locking Footrest	399
MBB	Moisture Barrier (Back)	89
MBS	Moisture Barrier (Seat)	89
MR	Monitor Arm (right side facing) ^{1,2}	849
MTR	Monitor Arm with Tray (right side facing) ^{1,2}	949
PR1	Paper Roll Holder ³	229
TE750	Trendelenburg (Bariatric)	459
USB	USB Power Outlet (IEC 60601-1 Certified)	459
WR	Wrist Restraint Mounts (pair)	229

TRAY TABLE OPTIONS

TD362	Dual Adjustable Side Trays, on Fold Down Arms ^{1,5}	898
TSR167	Adjustable (Right) Side Tray, on Fold Down Arm ^{1,5}	449
TSL167	Adjustable (Left) Side Tray, on Fold Down Arm ^{1,5}	449

FOLD DOWN TRANSFER ARM SPECIFIC

HC	Hinge Cover	Standard
----	-------------	----------

¹Includes QR bracket connection installed on recliner

²Standard on right side (facing). Replace "R" with "L" for left side (facing) option where available.

³Takes place of Push Bar. Paper sold separately.

⁴Contact customer service for solid surface pricing

⁵Over the lap tray function recommended in seated position.



Select Aesthetic Style (Denotes back & arm design)

E EV-Narrow Arm

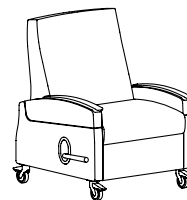
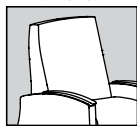

Dual Fold Down Arms

Select Functional Style (Aesthetic style code precedes selected model number below, e.g., KC1117)

B4062 Bari. Mobile Healthcare Recliner - Narrow Arms - Inf. Position Non-Locking Back - Dual Fold Down Arms

COM	Dillon/Carson	A ₅	B ₆	C ₇	D ₈	E ₉	F ₁₀	G ₁₁	H ₁₂	I ₁₃
6799	6809	6969	7169	7529	7739	8149	8599	10269	10579	11319

B4162 Bari. Mobile Healthcare Recliner - Narrow Arms - Inf. Position Locking Back - Dual Fold Down Arms

COM	Dillon/Carson	A ₅	B ₆	C ₇	D ₈	E ₉	F ₁₀	G ₁₁	H ₁₂	I ₁₃
7209	7219	7419	7599	7879	8139	8569	8959	10669	11059	11749

BC4062 Bari. Mobile Healthcare Chaise Recliner - Narrow Arms - Inf. Position Non-Locking Back - Dual Fold Down Arms

COM	Dillon/Carson	A ₅	B ₆	C ₇	D ₈	E ₉	F ₁₀	G ₁₁	H ₁₂	I ₁₃
6969	7069	7249	7569	7939	8269	8759	9289	11289	11849	12499

BC4162 Bari. Mobile Healthcare Chaise Recliner - Narrow Arms - Inf. Position Locking Back - Dual Fold Down Arms

COM	Dillon/Carson	A ₅	B ₆	C ₇	D ₈	E ₉	F ₁₀	G ₁₁	H ₁₂	I ₁₃
7389	7489	7679	7929	8369	8649	9139	9689	11679	12329	12929

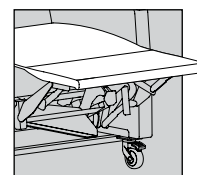

Chaise Models

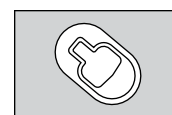

Locking Back Lever (located on outside arm on applicable models)

Dimensions

EB4062 EB4162 EBC4062 EBC4162	Overall			Seat			Back H	Arm H	Kick Out Seat D	Recline D	Distance from Wall
	W	D	H	W	D	H					
	37	34.5	47.5	29	21	21.5	28.5	27	40	75.5	20

General Info

COM: 8 yds
w/ Chaise COM: 9 yds
Wt Cap: 750 lb
Unit Weight: 162 lb

Available Options

ARM CAP OPTIONS

See pg 2 for finishes

U	Urethane	Standard
J1	Solid Surface - Group 1	619
J2	Solid Surface - Group 2	819

CASTER OPTIONS

Q3	3" - Dual Wheel Central Locking System	1019
Q4	4" - Central Lock & Steer System	1019
Q5	5" - Central Lock & Steer System	1139
S4	4" - (2) Caster Lock & Steer System	569
453R1	4" - (3) Swivel/(1) Rigid Locking Casters	Standard
4S4	4" - (4) Swivel Locking Casters	39

HEAT/MASSAGE OPTIONS (IEC 60601-1 CERTIFIED)

Wand Controls

HW	Heat	1139
HMW	Heat & Massage	1369

ADDITIONAL FEATURES & OPTIONS

PB	Push Bar	Standard
EG	Protective Edge Guard	Standard
QR	Additional Quick Release Accessory Bracket	69
CAL	CAL TB133	See pg 9
Z	Multi Cover	Use Pricing for Highest Grade

PATIENT WELLNESS & COMFORT OPTIONS

AHP	Adjustable Head Rest Pillow (COM 1 yd)	339
DP	Dual IV Poles & Brackets ¹	498
FBH	Foley Bag Holder	89
FT	Foot Tray	279
IV	IV Pole & Bracket ¹	249
LC	LiquiCell	229
LCKFR	Orthopedic Locking Footrest	399
MBB	Moisture Barrier (Back)	89
MBS	Moisture Barrier (Seat)	89
MR	Monitor Arm (right side facing) ^{1,2}	849
MTR	Monitor Arm with Tray (right side facing) ^{1,2}	949
PR1	Paper Roll Holder ³	229
TE750	Trendelenburg (Bariatric)	459
USB	USB Power Outlet (IEC 60601-1 Certified)	459
WR	Wrist Restraint Mounts (pair)	229

TRAY TABLE OPTIONS

TD362	Dual Adjustable Side Trays, on Fold Down Arms ^{1,5}	898
TSR167	Adjustable (Right) Side Tray, on Fold Down Arm ^{1,5}	449
TSL167	Adjustable (Left) Side Tray, on Fold Down Arm ^{1,5}	449

FOLD DOWN TRANSFER ARM SPECIFIC

HC	Hinge Cover	Standard
----	-------------	----------

Refer to pg 107 for full option details and images

¹Includes QR bracket connection installed on recliner

²Standard on right side (facing). Replace "R" with "L" for left side (facing) option where available.

³Takes place of Push Bar. Paper sold separately.

⁴Contact customer service for solid surface pricing

⁵Over the lap tray function recommended in seated position.



Select Aesthetic Style (Denotes back & arm design)

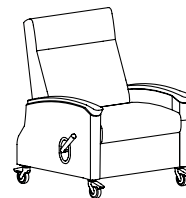
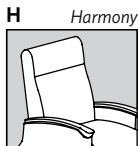

Single Removable Arm

Select Functional Style (Aesthetic style code precedes selected model number below, e.g., KC117)

5057 Bariatric Mobile Healthcare Recliner - Infinite Position Non-Locking Back - Single Removable Arm

COM	Dillon/Carson	A ₅	B ₆	C ₇	D ₈	E ₉	F ₁₀	G ₁₁	H ₁₂	I ₁₃
5229	5389	5559	5889	6309	6679	7159	7749	9489	9999	10739

5157 Bariatric Mobile Healthcare Recliner - Infinite Position Locking Back - Single Removable Arm

COM	Dillon/Carson	A ₅	B ₆	C ₇	D ₈	E ₉	F ₁₀	G ₁₁	H ₁₂	I ₁₃
5659	5809	5979	6299	6729	7079	7549	8139	9869	10399	10919

C5057 Bariatric Mobile Healthcare Chaise Recliner - Infinite Position Non-Locking Back - Single Removable Arm

COM	Dillon/Carson	A ₅	B ₆	C ₇	D ₈	E ₉	F ₁₀	G ₁₁	H ₁₂	I ₁₃
5469	5659	5869	6299	6789	7239	7799	8519	10389	10939	11479

C5157 Bariatric Mobile Healthcare Chaise Recliner - Infinite Position Locking Back - Single Removable Arm

COM	Dillon/Carson	A ₅	B ₆	C ₇	D ₈	E ₉	F ₁₀	G ₁₁	H ₁₂	I ₁₃
5899	6079	6289	6699	7209	7639	8199	8909	10769	11219	11719

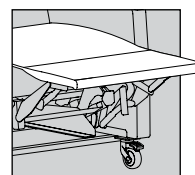

Chaise Models

NOTE: Transfer arm standard on right side (facing). If specified on left side, handle will be placed on right side and vice versa.

Dimensions

H5057 H5157 HC5057 HC5157	Overall			Seat			Back H	Arm H	Kick Out Seat D	Recline D	Distance from Wall
	W	D	H	W	D	H					
	39	38	47	29	21	21.5	26	28	40	73	19

General Info

COM: 8 yds
w/ Chaise COM: 9 yds
Wt Cap: 750 lb
Unit Weight: 169 lb

Available Options

ARM CAP OPTIONS

See pg 2 for finishes

U	Urethane (black only in Harmony style)	Standard
---	--	----------

CASTER OPTIONS

S4	4" - (2) Caster Lock & Steer System	569
4S3R1	4" - (3) Swivel/(1) Rigid Locking Casters	Standard
4S4	4" - (4) Swivel Locking Casters	39

HEAT/MASSAGE OPTIONS (IEC 60601-1 CERTIFIED)

Wand Controls

HW	Heat	1139
HMW	Heat & Massage	1369

In-Arm Controls

H	Heat	849
HM	Heat & Massage	1119

ADDITIONAL FEATURES & OPTIONS

PB	Push Bar	Standard
EG	Protective Edge Guard	Standard
QR	Additional Quick Release Accessory Bracket	69
CAL	CAL TB133	See pg 9
Z	Multi Cover	Use Pricing for Highest Grade

PATIENT WELLNESS & COMFORT OPTIONS

AHP	Adjustable Head Rest Pillow (COM 1 yd)	339
DP	Dual IV Poles & Brackets ¹	498
FBH	Foley Bag Holder	89
FT	Foot Tray	279
IV	IV Pole & Bracket ¹	249
LC	LiquiCell	229
LCKFR	Orthopedic Locking Footrest	399
MBB	Moisture Barrier (Back)	89
MBS	Moisture Barrier (Seat)	89
MR	Monitor Arm (right side facing) ^{1,2}	849
MTR	Monitor Arm with Tray (right side facing) ^{1,2}	949
PR1	Paper Roll Holder ³	229
TE750	Trendelenburg (Bariatric)	459
USB	USB Power Outlet (IEC 60601-1 Certified)	459
WR	Wrist Restraint Mounts (pair)	229

TRAY TABLE OPTIONS

TSR1	Adjustable (Right) Side Tray ^{1,2,5}	399
TD3	Dual Adjustable Side Trays (TSR1 & TSL1) ^{1,5}	798

Refer to pg 107 for full option details and images

¹Includes QR bracket connection installed on recliner

²Standard on right side (facing). Replace "R" with "L" for left side (facing) option where available.

³Takes place of Push Bar. Paper sold separately.

⁴Contact customer service for solid surface pricing

⁵Over the lap tray function recommended in seated position.



DURABLE® POWER SERIES



Series Overview

The Durable® Power Series combines over a half century of recliner mastery with leading, proven technology to create something completely new to the healthcare space—fully adjustable infinite position power recliners featuring weightless zero gravity capability. The intuitive control wand is preset with easy access buttons for the most common positions, while individual movement controls allow users to fine tune the footrest, back, and seat angle to their specific level of comfort. These features are found across healthcare recliners and healthcare recliners with lift assist functionality.

General Product Information

- 650 lb Static / 500 lb Dynamic Weight Rating
- Designed for 24/7 use healthcare environments
- Available with Lift Assist function
- Power operated recline functionality via control wand
- Footrest, back, and seat pitch can be controlled independently and precisely
- Control wand preset buttons include: Trendelenburg, Sleep, Zero Gravity, and Home (base position)
- Quick removable back & lift up seat for ease of cleaning
- True flatbed sleep position
- Standard with Chaise Continuous Leg Support feature
- Sinuous spring seat and back
- Seat clean-out
- Mid-Ottoman Calf Support
- Infinite Position Back reclines to infinite angle positions
- All interior plywood California Carb Compliant/Phase II
- Field replaceable components

Options vary by model, see specific model page for list of available options

Refer to pg 107 for full option details and images

To Order, Specify

- Model Number
- Textile
- Finish
- Options

DURABLE® POWER SERIES

ZG Power Healthcare Recliner

Select Aesthetic Style (Denotes back & arm design)

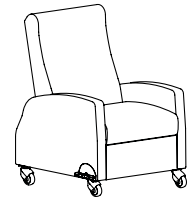
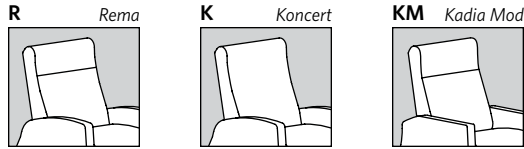

(Konkert style pictured)

Functional Style (Aesthetic style code precedes selected model number below, e.g., KCZP17)

CZP17 ZG Power Healthcare Recliner

COM	Dillon/Carson	A ₅	B ₆	C ₇	D ₈	E ₉	F ₁₀	G ₁₁	H ₁₂	I ₁₃
9199	9479	9739	9999	10259	10529	10919	11319	11839	12369	13029

Standard Features

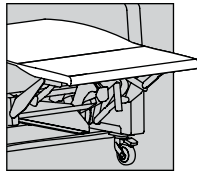

Chaise Continuous Leg Support

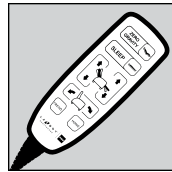

Recline Functions Operated by Intuitive Control Wand

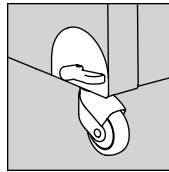

4" Central Locking Caster System

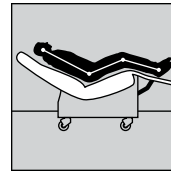

Weightless Zero Gravity Position via Wand Preset

Dimensions

	Overall			Seat			Back H	Arm H	Kick Out Seat D	Recline D	Distance from Wall
	W	D	H	W	D	H					
RCZP17 KCZP17	33	37	46.5	24	21	22	27.5	26.5	40.5	68	15.5
KMCZP17	33	37	46.5	24	21	22	27.5	26.5	40.5	68	15.5

General Info

COM:	6 yds
Static Wt Cap:	650 lb
Dynamic Wt Cap:	500 lb
Unit Weight:	174 lb

Available Options

ARM CAP OPTIONS

See pg 2 for finishes

U	Urethane	169
J1	Solid Surface - Group 1	619
J2	Solid Surface - Group 2	819
F	Fully Upholstered Arms	Standard

CASTER OPTIONS

Z-Q3	3" - Dual Wheel Central Locking System	No Charge
Z-Q4	4" - Central Locking System	Standard
Z-Q5	5" - Central Locking System	119

HEAT/MASSAGE OPTIONS (IEC 60601-1 CERTIFIED)

<i>Wand Controls</i>		
HW	Heat	1139
HMW	Heat & Massage	1369
<i>In-Arm Controls</i>		
H	Heat	849
HM	Heat & Massage	1119

ADDITIONAL FEATURES & OPTIONS

BBU	Battery Back Up	649
PB	Push Bar	Standard
EG	Protective Edge Guard	Standard
QR	Additional Quick Release Accessory Bracket	69
CAL	CAL TB133	See pg 9
Z	Multi Cover	Use Pricing for Highest Grade

PATIENT WELLNESS & COMFORT OPTIONS

ABP	Adjustable Back Pad (COM 1.75 yds)	
	Textile Grades COM-B	459
	Textile Grades C-I	569
AHP	Adjustable Head Rest Pillow (COM 1 yd)	339
DP	Dual IV Poles & Brackets ¹	498
FBH	Foley Bag Holder	89
FT	Foot Tray	279
IV	IV Pole & Bracket ¹	249
LC	LiquiCell	229
LCKFR	Orthopedic Locking Footrest ⁶	Standard
MBB	Moisture Barrier (Back)	59
MBS	Moisture Barrier (Seat)	59
MR	Monitor Arm (right side facing) ^{1,2}	849
MTR	Monitor Arm with Tray (right side facing) ^{1,2}	949
PR1	Paper Roll Holder ³	229
TE	Trendelenburg	Standard
USB	USB Power Outlet (IEC 60601-1 Certified)	459
WR	Wrist Restraint Mounts (pair)	229

TRAY TABLE OPTIONS

TSR1	Adjustable (Right) Side Tray ^{1,2,5}	399
TD3	Dual Adjustable Side Trays (TSR1 & TSL1) ^{1,5}	798
LFSTR	Large Folding (Right) Side Tray ⁴	249
LFSTRCH	Large Folding Cup Holder (Right) Side Tray	319
PLFSTR	Padded Large Folding (Right) Side Tray	379
SFSTR	Small Folding (Right) Side Tray ⁴	249

Refer to pg 107 for full option details and images

¹Includes QR bracket connection installed on recliner

²Standard on right side (facing). Replace "R" with "L" for left side (facing) option where available.

³Takes place of Push Bar. Paper sold separately.

⁴Contact customer service for solid surface pricing

⁵Over the lap tray function recommended in seated position.

⁶Position is locked in place by motors and can only be adjusted by the control wand.

Select Aesthetic Style (Denotes back & arm design)

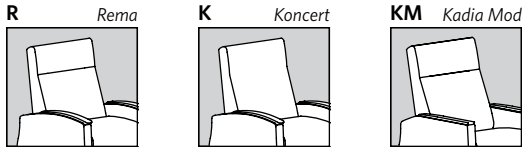

Single Fold Down Arm (Konkert style pictured)

Functional Style (Aesthetic style code precedes selected model number below, e.g., KCZP17)

CZP67 ZG Power Healthcare Recliner - Single Fold Down Arm

COM	Dillon/Carson	A ₅	B ₆	C ₇	D ₈	E ₉	F ₁₀	G ₁₁	H ₁₂	I ₁₃
10129	10399	10659	10919	11179	11449	11839	12239	12759	13299	13949

Standard Features

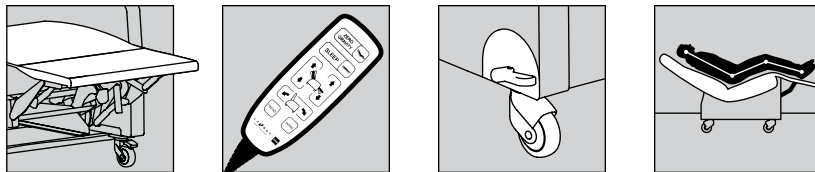

Chaise Continuous Leg Support

Recline Functions Operated by Intuitive Control Wand

4" Central Locking Caster System

Weightless Zero Gravity Position via Wand Preset

NOTE: Transfer arm standard on right side (facing). Left side (facing) available, please specify if requested.

Dimensions

	Overall			Seat			Back H	Arm H	Kick Out Seat D	Recline D	Distance from Wall
	W	D	H	W	D	H					
RCZP67 KCZP67	33	37	46.5	24	21	22	27.5	26.5	40.5	68	15.5
KMCZP67	33	37	46.5	24	21	22	27.5	26.5	40.5	68	15.5

General Info

COM: 7 yds
 Static Wt Cap: 650 lb
 Dynamic Wt Cap: 500 lb
 Unit Weight: 174 lb

Available Options *Refer to pg 107 for full option details and images*

ARM CAP OPTIONS		See pg 2 for finishes	PATIENT WELLNESS & COMFORT OPTIONS	
U	Urethane	Standard	ABP	Adjustable Back Pad (COM 1.75 yds) Textile Grades COM-B 459 Textile Grades C-I 569
J1	Solid Surface - Group 1	619	AHP	Adjustable Head Rest Pillow (COM 1 yd) 339
J2	Solid Surface - Group 2	819	DP	Dual IV Poles & Brackets ¹ 498
CASTER OPTIONS			FBH	Foley Bag Holder 89
Z-Q3	3" - Dual Wheel Central Locking System	No Charge	FT	Foot Tray 279
Z-Q4	4" - Central Locking System	Standard	IV	IV Pole & Bracket ¹ 249
Z-Q5	5" - Central Locking System	119	LC	LiquiCell 229
HEAT/MASSAGE OPTIONS (IEC 60601-1 CERTIFIED)			LCKFR	Orthopedic Locking Footrest ⁶ Standard
Wand Controls			MBB	Moisture Barrier (Back) 59
HW	Heat	1139	MBS	Moisture Barrier (Seat) 59
HMW	Heat & Massage	1369	MR	Monitor Arm (right side facing) ^{1,2} 849
In-Arm Controls			MTR	Monitor Arm with Tray (right side facing) ^{1,2} 949
H	Heat	849	PR1	Paper Roll Holder ³ 229
HM	Heat & Massage	1119	TE	Trendelenburg Standard
ADDITIONAL FEATURES & OPTIONS			USB	USB Power Outlet (IEC 60601-1 Certified) 459
BBU	Battery Back Up	649	WR	Wrist Restraint Mounts (pair) 229
PB	Push Bar	Standard	TRAY TABLE OPTIONS	
EG	Protective Edge Guard	Standard	TSL1	Adjustable (Left) Side Tray, on Stationary Arm ^{1,5} 399
QR	Additional Quick Release Accessory Bracket	69	TSR167	Adjustable (Right) Side Tray, on Fold Down Arm ^{1,2,5} 449
CAL	CAL TB133	See pg 9	LFSTR	Large Folding (Right) Side Tray ^{2,4} 249
Z	Multi Cover	Use Pricing for Highest Grade	LFSTRCH	Large Folding Cup Holder (Right) Side Tray ² 319
			PLFSTR	Padded Large Folding (Right) Side Tray ² 379
			SFSTR	Small Folding (Right) Side Tray ^{2,4} 249
			FOLD DOWN TRANSFER ARM SPECIFIC	
			HC	Hinge Cover Standard

¹Includes QR bracket connection installed on recliner
²Standard on right side (facing). Replace "R" with "L" for left side (facing) option where available.
³Takes place of Push Bar. Paper sold separately.

⁴Contact customer service for solid surface pricing
⁵Over the lap tray function recommended in seated position.
⁶Position is locked in place by motors and can only be adjusted by the control wand.



Select Aesthetic Style (Denotes back & arm design)

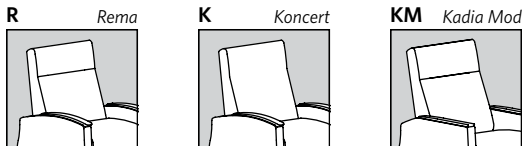

Dual Fold Down Arms
(Koncert style pictured)

Functional Style (Aesthetic style code precedes selected model number below, e.g., KCZP17)

CZP62 ZG Power Healthcare Recliner - Dual Fold Down Arms

COM	Dillon/Carson	A ₅	B ₆	C ₇	D ₈	E ₉	F ₁₀	G ₁₁	H ₁₂	I ₁₃
10789	11049	11319	11579	11839	12109	12499	12899	13419	13949	14599

Standard Features

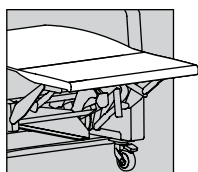

Chaise Continuous Leg Support

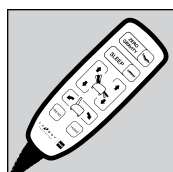

Recline Functions Operated by Intuitive Control Wand

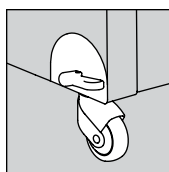

4" Central Locking Caster System

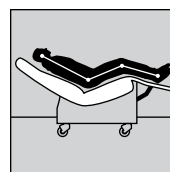

Weightless Zero Gravity Position via Wand Preset

Dimensions

	Overall			Seat			Back H	Arm H	Kick Out Seat D	Recline D	Distance from Wall
	W	D	H	W	D	H					
RCZP62 KCZP62	33	37	46.5	24	21	22	27.5	26.5	40.5	68	15.5
KMCZP62	33	37	46.5	24	21	22	27.5	26.5	40.5	68	15.5

General Info

COM: 7 yds
 Static Wt Cap: 650 lb
 Dynamic Wt Cap: 500 lb
 Unit Weight: 174 lb

Available Options *Refer to pg 107 for full option details and images*

ARM CAP OPTIONS

See pg 2 for finishes

U	Urethane	Standard
J1	Solid Surface - Group 1	619
J2	Solid Surface - Group 2	819

CASTER OPTIONS

Z-Q3	3" - Dual Wheel Central Locking System	No Charge
Z-Q4	4" - Central Locking System	Standard
Z-Q5	5" - Central Locking System	119

HEAT/MASSAGE OPTIONS (IEC 60601-1 CERTIFIED)

Wand Controls		
HW	Heat	1139
HMW	Heat & Massage	1369

ADDITIONAL FEATURES & OPTIONS

BBU	Battery Back Up	649
PB	Push Bar	Standard
EG	Protective Edge Guard	Standard
QR	Additional Quick Release Accessory Bracket	69
CAL	CAL TB133	See pg 9
Z	Multi Cover	Use Pricing for Highest Grade

PATIENT WELLNESS & COMFORT OPTIONS

ABP	Adjustable Back Pad (COM 1.75 yds)	
	Textile Grades COM-B	459
	Textile Grades C-I	569
AHP	Adjustable Head Rest Pillow (COM 1 yd)	339
DP	Dual IV Poles & Brackets ¹	498
FBH	Foley Bag Holder	89
FT	Foot Tray	279
IV	IV Pole & Bracket ¹	249
LC	LiquiCell	229
LCKFR	Orthopedic Locking Footrest ⁶	Standard
MBB	Moisture Barrier (Back)	59
MBS	Moisture Barrier (Seat)	59
MR	Monitor Arm (right side facing) ^{1,2}	849
MTR	Monitor Arm with Tray (right side facing) ^{1,2}	949
PR1	Paper Roll Holder ³	229
TE	Trendelenburg	Standard
USB	USB Power Outlet (IEC 60601-1 Certified)	459
WR	Wrist Restraint Mounts (pair)	229

TRAY TABLE OPTIONS

TD362	Dual Adjustable Side Trays, on Fold Down Arms ^{1,5}	898
TSR167	Adjustable (Right) Side Tray, on Fold Down Arm ^{1,5}	449
TSL167	Adjustable (Left) Side Tray, on Fold Down Arm ^{1,5}	449

FOLD DOWN TRANSFER ARM SPECIFIC

HC	Hinge Cover	Standard
----	-------------	----------

¹Includes QR bracket connection installed on recliner

²Standard on right side (facing). Replace "R" with "L" for left side (facing) option where available.

³Takes place of Push Bar. Paper sold separately.

⁴Contact customer service for solid surface pricing

⁵Over the lap tray function recommended in seated position.

⁶Position is locked in place by motors and can only be adjusted by the control wand.



DURABLE® POWER SERIES

ZG Lift Assist Power Healthcare Recliner

Select Aesthetic Style *(Denotes back & arm design)*

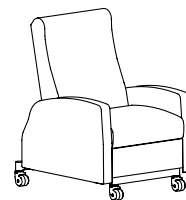
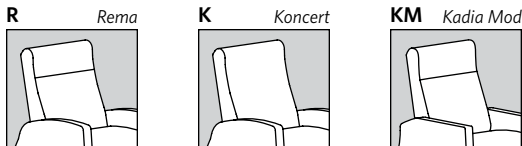

(Konkert style pictured)

Functional Style *(Aesthetic style code precedes selected model number below, e.g., KCZL17)*

CZL17 ZG Lift Assist Power Healthcare Recliner

COM	Dillon/Carson	A ₅	B ₆	C ₇	D ₈	E ₉	F ₁₀	G ₁₁	H ₁₂	I ₁₃
11199	11999	12499	12899	13029	13159	13419	13699	14349	14749	15269

Standard Features

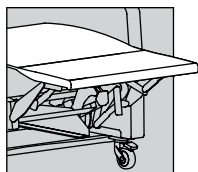

Chaise Continuous Leg Support

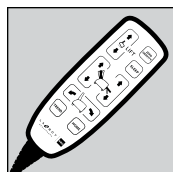

Recline Functions Operated by Intuitive Control Wand

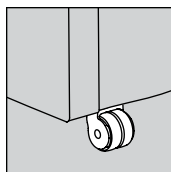

3" Automatic Central Locking Caster System

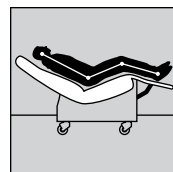

Weightless Zero Gravity Position via Wand Preset

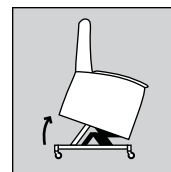

Lift Assist Function Aids User in Exiting Chair

Dimensions

	Overall			Seat			Back H	Arm H	Kick Out Seat D	Recline D	Distance from Wall
	W	D	H	W	D	H					
RCZL17 KCZL17	30.5	38.5	47.5	24	21.5	23.5	28	29.5	39	87.5	18.75
KMCZL17	30.5	38.5	47.5	24	21.5	23.5	28	29.5	39	87.5	18.75

General Info

COM: 6 yds
 Static Wt Cap: 650 lb
 Dynamic Wt Cap: 500 lb
 Unit Weight: 214 lb

Available Options

ARM CAP OPTIONS

See pg 2 for finishes

U	Urethane	169
J1	Solid Surface - Group 1	619
J2	Solid Surface - Group 2	819
F	Fully Upholstered Arms	Standard

CASTER OPTIONS

ZL-Q3	3" Auto-Locking Central Caster System	Standard
ZL-Q4	4" Auto-Locking Central Caster System <i>Increases seat height by 1"</i>	No Charge
ZL-Q5	5" Auto-Locking Central Caster System <i>Increases seat height by 2"</i>	119

HEAT/MASSAGE OPTIONS (IEC 60601-1 CERTIFIED)

<i>Wand Controls</i>		
HW	Heat	1139
HMW	Heat & Massage	1369
<i>In-Arm Controls</i>		
H	Heat	849
HM	Heat & Massage	1119

ADDITIONAL FEATURES & OPTIONS

BBU	Battery Back Up	649
PB	Push Bar	Standard
EG	Protective Edge Guard	Standard
CAL	CAL TB133	See pg 9
Z	Multi Cover	Use Pricing for Highest Grade

PATIENT WELLNESS & COMFORT OPTIONS

ABP	Adjustable Back Pad (COM 1.75 yds)	
	Textile Grades COM-B	459
	Textile Grades C-I	569
AHP	Adjustable Head Rest Pillow (COM 1 yd)	339
FT	Foot Tray	279
LC	LiquiCell	229
LCKFR	Orthopedic Locking Footrest ⁶	Standard
MBB	Moisture Barrier (Back)	59
MBS	Moisture Barrier (Seat)	59
PR1	Paper Roll Holder ³	229
TE	Trendelenburg	Standard
USB	USB Power Outlet (IEC 60601-1 Certified)	459

Refer to pg 107 for full option details and images

³Takes place of Push Bar. Paper sold separately.

⁶Position is locked in place by motors and can only be adjusted by the control wand.

DURABLE® POWER SERIES ZG Lift Assist Power Healthcare Recliner | Patient Transfer

Select Aesthetic Style *(Denotes back & arm design)*

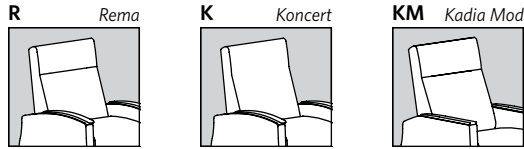

Functional Style *(Aesthetic style code precedes selected model number below, e.g., KCZL17)*

CZL67 ZG Lift Assist Power Healthcare Recliner - Single Fold Down Arm

COM	Dillon/Carson	A ₅	B ₆	C ₇	D ₈	E ₉	F ₁₀	G ₁₁	H ₁₂	I ₁₃
12249	12769	12899	13159	13429	13699	13999	14479	14869	15399	15999

Single Fold Down Arm
(Koncert style pictured)

NOTE: Transfer arm standard on right side (facing). Left side (facing) available, please specify if requested.

Standard Features

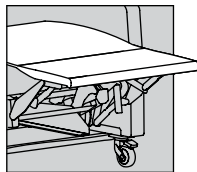

Chaise Continuous Leg Support

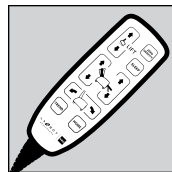

Recline Functions Operated by Intuitive Control Wand

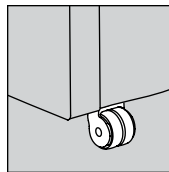

3" Automatic Central Locking Caster System

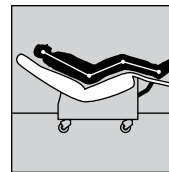

Weightless Zero Gravity Position via Wand Preset

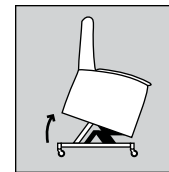

Lift Assist Function Aids User in Exiting Chair

Dimensions

	Overall			Seat			Back H	Arm H	Kick Out Seat D	Recline D	Distance from Wall
	W	D	H	W	D	H					
RCZL67 KCZL67	30.5	38.5	47.5	24	21.5	23.5	28	29.5	39	87.5	18.75
KMCZL67	30.5	38.5	47.5	24	21.5	23.5	28	29.5	39	87.5	18.75

General Info

COM: 7 yds
Static Wt Cap: 650 lb
Dynamic Wt Cap: 500 lb
Unit Weight: 214 lb

Available Options

ARM CAP OPTIONS

See pg 2 for finishes

U	Urethane	Standard
J1	Solid Surface - Group 1	619
J2	Solid Surface - Group 2	819

CASTER OPTIONS

ZL-Q3	3" Auto-Locking Central Caster System	Standard
ZL-Q4	4" Auto-Locking Central Caster System <i>Increases seat height by 1"</i>	No Charge
ZL-Q5	5" Auto-Locking Central Caster System <i>Increases seat height by 2"</i>	119

HEAT/MASSAGE OPTIONS (IEC 60601-1 CERTIFIED)

<i>Wand Controls</i>		
HW	Heat	1139
HMW	Heat & Massage	1369
<i>In-Arm Controls</i>		
H	Heat	849
HM	Heat & Massage	1119

ADDITIONAL FEATURES & OPTIONS

BBU	Battery Back Up	649
PB	Push Bar	Standard
EG	Protective Edge Guard	Standard
CAL	CAL TB133	See pg 9
Z	Multi Cover	Use Pricing for Highest Grade

PATIENT WELLNESS & COMFORT OPTIONS

ABP	Adjustable Back Pad (COM 1.75 yds)	
	Textile Grades COM-B	459
	Textile Grades C-I	569
AHP	Adjustable Head Rest Pillow (COM 1 yd)	339
FT	Foot Tray	279
LC	LiquiCell	229
LCKFR	Orthopedic Locking Footrest ⁶	Standard
MBB	Moisture Barrier (Back)	59
MBS	Moisture Barrier (Seat)	59
PR1	Paper Roll Holder ³	229
TE	Trendelenburg	Standard
USB	USB Power Outlet (IEC 60601-1 Certified)	459

Refer to pg 107 for full option details and images

³Takes place of Push Bar. Paper sold separately.

⁶Position is locked in place by motors and can only be adjusted by the control wand.

DURABLE® POWER SERIES ZG Lift Assist Power Healthcare Recliner | Patient Transfer

Select Aesthetic Style (Denotes back & arm design)

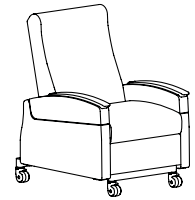
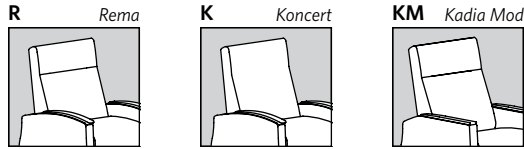

Dual Fold Down Arms
(Koncert style pictured)

Functional Style (Aesthetic style code precedes selected model number below, e.g., KCZL17)

CZL62 ZG Lift Assist Power Healthcare Recliner - Dual Fold Down Arms

COM	Dillon/Carson	A ₅	B ₆	C ₇	D ₈	E ₉	F ₁₀	G ₁₁	H ₁₂	I ₁₃
12869	13159	13299	13679	13879	14209	14479	14869	15399	15799	16319

Standard Features

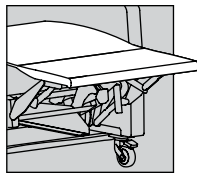

Chaise Continuous
Leg Support

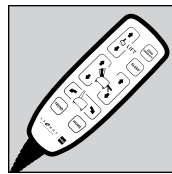

Recline Functions Operated
by Intuitive Control Wand

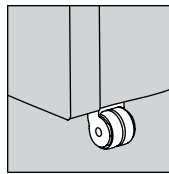

3" Automatic Central
Locking Caster System

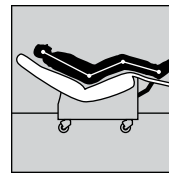

Weightless Zero Gravity
Position via Wand Preset

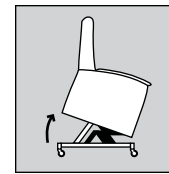

Lift Assist Function
Aids User in Exiting Chair

Dimensions

	Overall			Seat			Back H	Arm H	Kick Out Seat D	Recline D	Distance from Wall
	W	D	H	W	D	H					
RCZL62 KCZL62	30.5	38.5	47.5	24	21.5	23.5	28	29.5	39	87.5	18.75
KMCZL62	30.5	38.5	47.5	24	21.5	23.5	28	29.5	39	87.5	18.75

General Info

COM: 7 yds
Static
Wt Cap: 650 lb
Dynamic
Wt Cap: 500 lb
Unit
Weight: 214 lb

Available Options

ARM CAP OPTIONS

See pg 2 for finishes

U	Urethane	Standard
J1	Solid Surface - Group 1	619
J2	Solid Surface - Group 2	819

CASTER OPTIONS

ZL-Q3	3" Auto-Locking Central Caster System	Standard
ZL-Q4	4" Auto-Locking Central Caster System <i>Increases seat height by 1"</i>	No Charge
ZL-Q5	5" Auto-Locking Central Caster System <i>Increases seat height by 2"</i>	119

HEAT/MASSAGE OPTIONS (IEC 60601-1 CERTIFIED)

Wand Controls

HW	Heat	1139
HMW	Heat & Massage	1369

ADDITIONAL FEATURES & OPTIONS

BBU	Battery Back Up	649
PB	Push Bar	Standard
EG	Protective Edge Guard	Standard
CAL	CAL TB133	See pg 9
Z	Multi Cover	Use Pricing for Highest Grade

PATIENT WELLNESS & COMFORT OPTIONS

ABP	Adjustable Back Pad (COM 1.75 yds)	
	Textile Grades COM-B	459
	Textile Grades C-I	569
AHP	Adjustable Head Rest Pillow (COM 1 yd)	339
FT	Foot Tray	279
LC	LiquiCell	229
LCKFR	Orthopedic Locking Footrest ⁶	Standard
MBB	Moisture Barrier (Back)	59
MBS	Moisture Barrier (Seat)	59
PR1	Paper Roll Holder ³	229
TE	Trendelenburg	Standard
USB	USB Power Outlet (IEC 60601-1 Certified)	459

Refer to pg 107 for full option details and images

³Takes place of Push Bar. Paper sold separately.

⁶Position is locked in place by motors and can only be adjusted by the control wand.

DURABLE® EXAM LIFT SERIES



Series Overview

The Exam Lift Series is engineered with threefold functionality as a recliner, exam surface, and sleep space (with true flatbed position). Exam Lift Series recliners raise to a 36" exam height in all positions, while providing trusted comfort, performance, and durability. For enhanced safety, a central locking caster system is standard on all models to secure the chair when the user is elevated, and a locking leg support mechanism prevents the footrest from lowering unintentionally.

General Product Information

- 650 lb Static / 500 lb Dynamic Weight Rating
- Designed for 24/7 use healthcare environments
- Raises to exam height via non-handed power foot pedal
- Power or manually operated recline functionality
- Footrest and back move in harmony when engaged
- Quick removable back & lift up seat for ease of cleaning
- Standard with Chaise Continuous Leg Support and Trendelenburg features
- Standard with Orthopedic Locking Footrest
- Sinuous spring seat and back
- Seat clean-out
- Mid-Ottoman Calf Support
- Infinite Position Back reclines to infinite angle positions
- All interior plywood California Carb Compliant/Phase II
- Field replaceable components

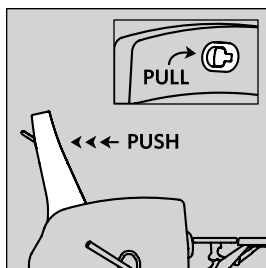

Infinite Position Locking Back

Allows patient/caregiver to lock back into any position. Lock lever located inside left (facing) arm on applicable models, unless otherwise noted/pictured. (manual recline models)

To Order, Specify

- Model Number
- Textile
- Finish
- Options

Options vary by model, see specific model page for list of available options

Refer to pg 107 for full option details and images

DURABLE[®] EXAM LIFT SERIES

ZG Exam Lift Power Healthcare Recliner

Select Aesthetic Style *(Denotes back & arm design)*

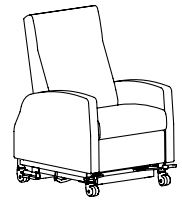
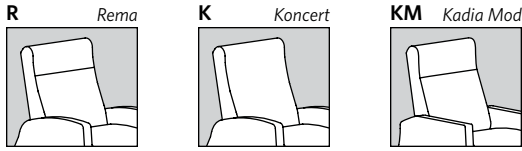

Functional Style *(Aesthetic style code precedes selected model number below, e.g., KCZX67)*

(Konzert style pictured)

CZX17 ZG Exam Lift Power Healthcare Recliner

COM	Dillon/Carson	A ₅	B ₆	C ₇	D ₈	E ₉	F ₁₀	G ₁₁	H ₁₂	I ₁₃
16319	16579	16709	17109	17369	17629	17899	18419	18949	19469	19869

Standard Features

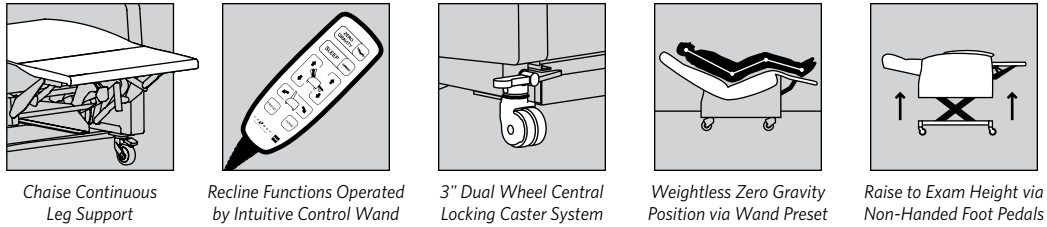

Dimensions

	Overall			Seat			Back H	Arm H	Kick Out Seat D	Recline D	Distance from Wall
	W	D	H	W	D	H					
RCZX17 KCZX17	34.5	38	48	24	21	23	26	28	40	73	20
KMCZX17	34.5	38	48	24	21	23	26	28	40	73	20

General Info	
COM:	7 yds
Static Wt Cap:	650 lb
Dynamic Wt Cap:	500 lb
Unit Weight:	281 lb

Available Options

ARM CAP OPTIONS		See pg 2 for finishes	PATIENT WELLNESS & COMFORT OPTIONS	
U	Urethane	169	ABP	Adjustable Back Pad (COM 1.75 yds) 459
J1	Solid Surface - Group 1	619		Textile Grades COM-B 569
J2	Solid Surface - Group 2	819	AHP	Adjustable Head Rest Pillow (COM 1 yd) 339
F	Fully Upholstered Arms	Standard	DP	Dual IV Poles & Brackets ¹ 498
CASTER OPTIONS			FBH	Foley Bag Holder 89
Z-Q3	3" - Dual Wheel Central Locking Casters	Standard	IV	IV Pole & Bracket ¹ 249
Z-Q4	4" - Central Locking System	No Charge	LC	LiquiCell 229
	<i>Increases seat height by 1".</i>		LCKFR	Orthopedic Locking Footrest ⁶ Standard
Z-Q5	5" - Central Locking System	119	MBB	Moisture Barrier (Back) 59
	<i>Increases seat height by 2".</i>		MBS	Moisture Barrier (Seat) 59
HEAT/MESSAGE OPTIONS (IEC 60601-1 CERTIFIED)			MR	Monitor Arm (right side facing) ^{1,2} 849
	<i>Wand Controls</i>		MTR	Monitor Arm with Tray (right side facing) ^{1,2} 949
HW	Heat	1139	PR1	Paper Roll Holder ³ 229
HMW	Heat & Massage	1369	TE	Trendelenburg Standard
	<i>In-Arm Controls</i>		USB	USB Power Outlet (IEC 60601-1 Certified) 459
H	Heat	849	WR	Wrist Restraint Mounts (pair) 229
HM	Heat & Massage	1119	TRAY TABLE OPTIONS	
ADDITIONAL FEATURES & OPTIONS			TSR1	Adjustable (Right) Side Tray ^{1,2,5} 399
BBU	Battery Back Up	649	TD3	Dual Adjustable Side Trays (TSR1 & TSL1) ^{1,5} 798
PB	Push Bar	Standard	LFSTR	Large Folding (Right) Side Tray ⁴ 249
EG	Protective Edge Guard	Standard	LFSTRCH	Large Folding Cup Holder (Right) Side Tray 319
QR	Additional Quick Release Accessory Bracket	69	PLFSTR	Padded Large Folding (Right) Side Tray 379
CAL	CAL TB133	See pg 9	SFSTR	Small Folding (Right) Side Tray ⁴ 249
Z	Multi Cover	Use Pricing for Highest Grade	*Refer to pg 107 for full option details and images*	

¹Includes QR bracket connection installed on recliner
²Standard on right side (facing). Replace "R" with "L" for left side (facing) option where available.
³Takes place of Push Bar. Paper sold separately.

⁴Contact customer service for solid surface pricing
⁵Over the lap tray function recommended in seated position.
⁶Position is locked in place by motors and can only be adjusted by the control wand.

DURABLE® EXAM LIFT SERIES ZG Exam Lift Power Healthcare Recliner | Patient Transfer

Select Aesthetic Style (Denotes back & arm design)

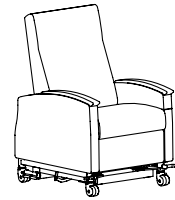
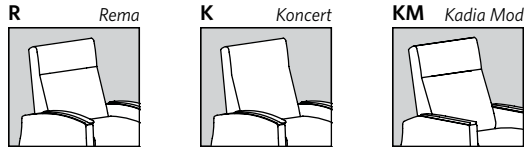

Functional Style (Aesthetic style code precedes selected model number below, e.g., KCZX67)

CZX67 ZG Exam Lift Power Healthcare Recliner - Single Fold Down Arm

COM	Dillon/Carson	A ₅	B ₆	C ₇	D ₈	E ₉	F ₁₀	G ₁₁	H ₁₂	I ₁₃
16839	17109	17239	17629	17899	18159	18549	19079	19599	20129	20659

Single Fold Down Arm
(Koncert style pictured)

NOTE: Transfer arm standard on right side (facing). Left side (facing) available, please specify if requested.

Standard Features

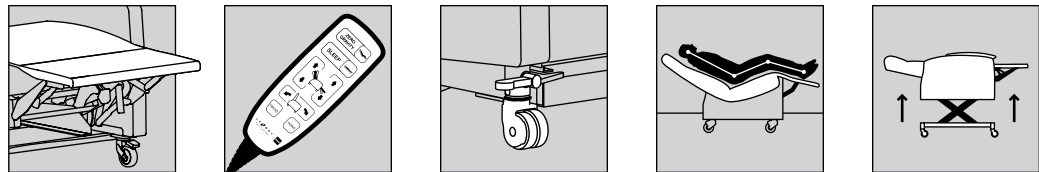

Chaise Continuous Leg Support

Recline Functions Operated by Intuitive Control Wand

3" Dual Wheel Central Locking Caster System

Weightless Zero Gravity Position via Wand Preset

Raise to Exam Height via Non-Handed Foot Pedals

Dimensions

		Overall			Seat			Back H	Arm H	Kick Out Seat D	Recline D	Distance from Wall
		W	D	H	W	D	H					
RCZX67	KCZX67	34.5	38	48	24	21	23	26	28	40	73	20
	KMCZX67	34.5	38	48	24	21	23	26	28	40	73	20

General Info

COM: 8 yds
Static Wt Cap: 650 lb
Dynamic Wt Cap: 500 lb
Unit Weight: 281 lb

Available Options *Refer to pg 107 for full option details and images*

ARM CAP OPTIONS

See pg 2 for finishes

U	Urethane	Standard
J1	Solid Surface - Group 1	619
J2	Solid Surface - Group 2	819

CASTER OPTIONS

Z-Q3	3" - Dual Wheel Central Locking Casters	Standard
Z-Q4	4" - Central Locking System <i>Increases seat height by 1".</i>	No Charge
Z-Q5	5" - Central Locking System <i>Increases seat height by 2".</i>	119

HEAT/MASSAGE OPTIONS (IEC 60601-1 CERTIFIED)

<i>Wand Controls</i>		
HW	Heat	1139
HMW	Heat & Massage	1369
<i>In-Arm Controls</i>		
H	Heat	849
HM	Heat & Massage	1119

ADDITIONAL FEATURES & OPTIONS

BBU	Battery Back Up	649
PB	Push Bar	Standard
EG	Protective Edge Guard	Standard
QR	Additional Quick Release Accessory Bracket	69
CAL	CAL TB133	See pg 9
Z	Multi Cover	Use Pricing for Highest Grade

PATIENT WELLNESS & COMFORT OPTIONS

ABP	Adjustable Back Pad (COM 1.75 yds) Textile Grades COM-B	459
	Textile Grades C-I	569
AHP	Adjustable Head Rest Pillow (COM 1 yd)	339
DP	Dual IV Poles & Brackets ¹	498
FBH	Foley Bag Holder	89
IV	IV Pole & Bracket ¹	249
LC	LiquiCell	229
LCKFR	Orthopedic Locking Footrest ⁶	Standard
MBB	Moisture Barrier (Back)	59
MBS	Moisture Barrier (Seat)	59
MR	Monitor Arm (right side facing) ^{1,2}	849
MTR	Monitor Arm with Tray (right side facing) ^{1,2}	949
PR1	Paper Roll Holder ³	229
TE	Trendelenburg	Standard
USB	USB Power Outlet (IEC 60601-1 Certified)	459
WR	Wrist Restraint Mounts (pair)	229

TRAY TABLE OPTIONS

TSL1	Adjustable (Left) Side Tray, on Stationary Arm ¹⁵	399
TSR167	Adjustable (Right) Side Tray, on Fold Down Arm ^{12,5}	449
LFSTR	Large Folding (Right) Side Tray ^{2,4}	249
LFSTRCH	Large Folding Cup Holder (Right) Side Tray ²	319
PLFSTR	Padded Large Folding (Right) Side Tray ²	379
SFSTR	Small Folding (Right) Side Tray ^{2,4}	249

FOLD DOWN TRANSFER ARM SPECIFIC

HC	Hinge Cover	Standard
----	-------------	----------

¹Includes QR bracket connection installed on recliner

²Standard on right side (facing). Replace "R" with "L" for left side (facing) option where available.

³Takes place of Push Bar. Paper sold separately.

⁴Contact customer service for solid surface pricing

⁵Over the lap tray function recommended in seated position.

⁶Position is locked in place by motors and can only be adjusted by the control wand.

DURABLE® EXAM LIFT SERIES ZG Exam Lift Power Healthcare Recliner | Patient Transfer

Select Aesthetic Style (Denotes back & arm design)

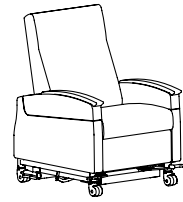
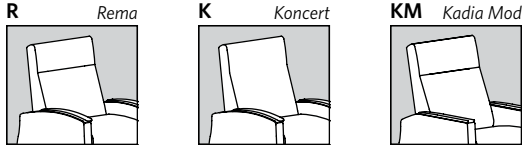

Functional Style (Aesthetic style code precedes selected model number below, e.g., KCZX67)

CZX62 ZG Exam Lift Power Healthcare Recliner - Dual Fold Down Arms

COM	Dillon/Carson	A ₅	B ₆	C ₇	D ₈	E ₉	F ₁₀	G ₁₁	H ₁₂	I ₁₃
17369	17629	17759	18159	18419	18679	19079	19739	20259	20919	21579

Dual Fold Down Arms
(Koncert style pictured)

Standard Features

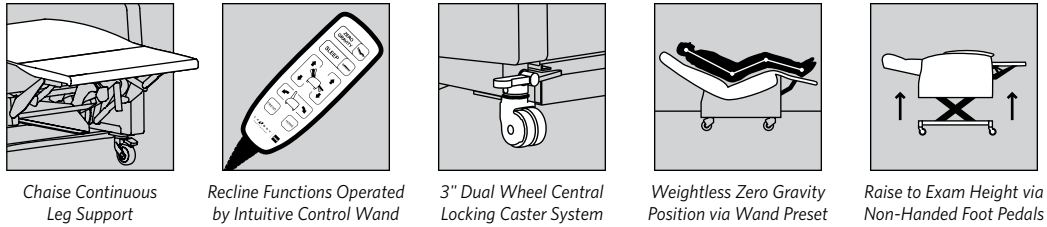

Chaise Continuous Leg Support

Recline Functions Operated by Intuitive Control Wand

3" Dual Wheel Central Locking Caster System

Weightless Zero Gravity Position via Wand Preset

Raise to Exam Height via Non-Handed Foot Pedals

Dimensions

	Overall			Seat			Back H	Arm H	Kick Out Seat D	Recline D	Distance from Wall
	W	D	H	W	D	H					
RCZX62 KCZX62	34.5	38	48	24	21	23	26	28	40	73	20
KMCZX62	34.5	38	48	24	21	23	26	28	40	73	20

General Info

COM:	8 yds
Static Wt Cap:	650 lb
Dynamic Wt Cap:	500 lb
Unit Weight:	281 lb

Available Options *Refer to pg 107 for full option details and images*

ARM CAP OPTIONS <small>See pg 2 for finishes</small>			PATIENT WELLNESS & COMFORT OPTIONS		
U	Urethane	Standard	ABP	Adjustable Back Pad (COM 1.75 yds)	
J1	Solid Surface - Group 1	619		Textile Grades COM-B	459
J2	Solid Surface - Group 2	819		Textile Grades C-I	569
CASTER OPTIONS			AHP	Adjustable Head Rest Pillow (COM 1 yd)	339
Z-Q3	3" - Dual Wheel Central Locking Casters	Standard	DP	Dual IV Poles & Brackets ¹	498
Z-Q4	4" - Central Locking System <small>Increases seat height by 1".</small>	No Charge	FBH	Foley Bag Holder	89
Z-Q5	5" - Central Locking System <small>Increases seat height by 2".</small>	119	IV	IV Pole & Bracket ¹	249
HEAT/MASSAGE OPTIONS (IEC 60601-1 CERTIFIED)			LC	LiquiCell	229
	Wand Controls		LCKFR	Orthopedic Locking Footrest ⁶	Standard
HW	Heat	1139	MBB	Moisture Barrier (Back)	59
HMW	Heat & Massage	1369	MBS	Moisture Barrier (Seat)	59
ADDITIONAL FEATURES & OPTIONS			MR	Monitor Arm (right side facing) ^{1,2}	849
BBU	Battery Back Up	649	MTR	Monitor Arm with Tray (right side facing) ^{1,2}	949
PB	Push Bar	Standard	PR1	Paper Roll Holder ³	229
EG	Protective Edge Guard	Standard	TE	Trendelenburg	Standard
QR	Additional Quick Release Accessory Bracket	69	USB	USB Power Outlet (IEC 60601-1 Certified)	459
CAL	CAL TB133	See pg 9	WR	Wrist Restraint Mounts (pair)	229
Z	Multi Cover	Use Pricing for Highest Grade	TRAY TABLE OPTIONS		
			TD362	Dual Adjustable Side Trays, on Fold Down Arms ^{1,5}	898
			TSR167	Adjustable (Right) Side Tray, on Fold Down Arm ^{1,5}	449
			TSL167	Adjustable (Left) Side Tray, on Fold Down Arm ^{1,5}	449
			FOLD DOWN TRANSFER ARM SPECIFIC		
			HC	Hinge Cover	Standard

¹Includes QR bracket connection installed on recliner

²Standard on right side (facing). Replace "R" with "L" for left side (facing) option where available.

³Takes place of Push Bar. Paper sold separately.

⁴Contact customer service for solid surface pricing

⁵Over the lap tray function recommended in seated position.

⁶Position is locked in place by motors and can only be adjusted by the control wand.

DURABLE® EXAM LIFT SERIES

Exam Lift Healthcare Recliner

Select Aesthetic Style *(Denotes back & arm design)*

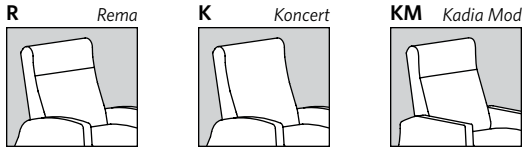

(Konkert style pictured)

Functional Style *(Aesthetic style code precedes selected model number below, e.g., KC7X67)*

C7X18 Exam Lift Recliner - Infinite Position Locking Back

COM	Dillon/Carson	A ₅	B ₆	C ₇	D ₈	E ₉	F ₁₀	G ₁₁	H ₁₂	I ₁₃
13469	13679	13839	13999	14209	14419	14599	14949	15419	15919	16319

Standard Features

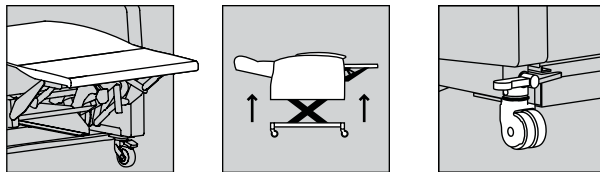

Chaise Continuous Leg Support

Raise to Exam Height via Non-Handed Foot Pedals

3" Dual Wheel Central Locking Caster System

Dimensions

	Overall			Seat			Back H	Arm H	Kick Out Seat D	Recline D	Distance from Wall
	W	D	H	W	D	H					
RC7X18 KC7X18	34.5	38	48	24	21	23	26	28	40	73	20
KMC7X18	34.5	38	48	24	21	23	26	28	40	73	20

General Info

COM: 6 yds
 Static Wt Cap: 650 lb
 Dynamic Wt Cap: 500 lb
 Unit Weight: 263 lb

Available Options

ARM CAP OPTIONS

See pg 2 for finishes

U	Urethane	169
J1	Solid Surface - Group 1	619
J2	Solid Surface - Group 2	819
F	Fully Upholstered Arms	Standard

CASTER OPTIONS

Z-Q3	3" - Dual Wheel Central Locking Casters	Standard
Z-Q4	4" - Central Locking System <i>Increases seat height by 1".</i>	No Charge
Z-Q5	5" - Central Locking System <i>Increases seat height by 2".</i>	119

HEAT/MASSAGE OPTIONS (IEC 60601-1 CERTIFIED)

<i>Wand Controls</i>		
HW	Heat	1139
HMW	Heat & Massage	1369
<i>In-Arm Controls</i>		
H	Heat	849
HM	Heat & Massage	1119

ADDITIONAL FEATURES & OPTIONS

BBU	Battery Back Up	649
PB	Push Bar	Standard
EG	Protective Edge Guard	Standard
QR	Additional Quick Release Accessory Bracket	69
CAL	CAL TB133	See pg 9
Z	Multi Cover	Use Pricing for Highest Grade

PATIENT WELLNESS & COMFORT OPTIONS

ABP	Adjustable Back Pad (COM 1.75 yds) Textile Grades COM-B	459
	Textile Grades C-I	569
AHP	Adjustable Head Rest Pillow (COM 1 yd)	339
DP	Dual IV Poles & Brackets ¹	498
FBH	Foley Bag Holder	89
IV	IV Pole & Bracket ¹	249
LC	LiquiCell	229
LCKFR	Orthopedic Locking Footrest	Standard
MBB	Moisture Barrier (Back)	59
MBS	Moisture Barrier (Seat)	59
MR	Monitor Arm (right side facing) ^{1,2}	849
MTR	Monitor Arm with Tray (right side facing) ^{1,2}	949
PR1	Paper Roll Holder ³	229
TE	Trendelenburg	Standard
USB	USB Power Outlet (IEC 60601-1 Certified)	459
WR	Wrist Restraint Mounts (pair)	229

TRAY TABLE OPTIONS

TSR1	Adjustable (Right) Side Tray ^{1,2,5}	399
TD3	Dual Adjustable Side Trays (TSR1 & TSL1) ^{1,5}	798
LFSTR	Large Folding (Right) Side Tray ⁴	249
LFSTRCH	Large Folding Cup Holder (Right) Side Tray	319
PLFSTR	Padded Large Folding (Right) Side Tray	379
SFSTR	Small Folding (Right) Side Tray ⁴	249

Refer to pg 107 for full option details and images

¹Includes QR bracket connection installed on recliner

²Standard on right side (facing). Replace "R" with "L" for left side (facing) option where available.

³Takes place of Push Bar. Paper sold separately.

⁴Contact customer service for solid surface pricing

⁵Over the lap tray function recommended in seated position.

DURABLE® EXAM LIFT SERIES

Exam Lift Healthcare Recliner | Patient Transfer

Select Aesthetic Style *(Denotes back & arm design)*

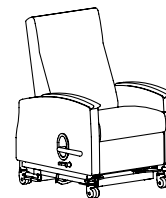
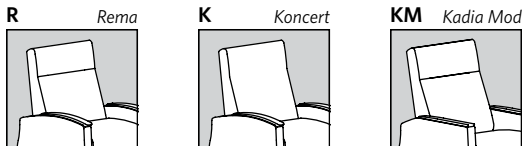

Functional Style *(Aesthetic style code precedes selected model number below, e.g., KC7X67)*

C7X67 Exam Lift Recliner - Infinite Position Locking Back - Single Fold Down Arm

COM	Dillon/Carson	A ₅	B ₆	C ₇	D ₈	E ₉	F ₁₀	G ₁₁	H ₁₂	I ₁₃
14079	14289	14529	14739	14949	15159	15369	15629	16109	16579	17109

Single Fold Down Arm
(Koncert style pictured)

Standard Features

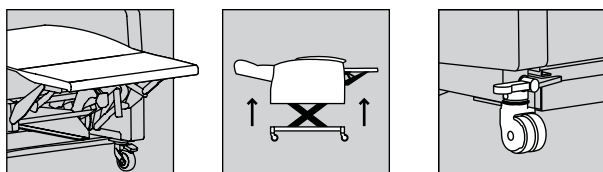

Chaise Continuous Leg Support

Raise to Exam Height via Non-Handed Foot Pedals

3" Dual Wheel Central Locking Caster System

NOTE: Transfer arm standard on right side (facing). If specified on left side, handle will be placed on right side and vice versa.

Dimensions

	Overall			Seat			Back H	Arm H	Kick Out Seat D	Recline D	Distance from Wall
	W	D	H	W	D	H					
RC7X67 KC7X67	34.5	38	48	24	21	23	26	28	40	73	20
KMC7X67	34.5	38	48	24	21	23	26	28	40	73	20

General Info

COM: 7 yds
 Static Wt Cap: 650 lb
 Dynamic Wt Cap: 500 lb
 Unit Weight: 263 lb

Available Options

ARM CAP OPTIONS

See pg 2 for finishes

U	Urethane	Standard
J1	Solid Surface - Group 1	619
J2	Solid Surface - Group 2	819

CASTER OPTIONS

Z-Q3	3" - Dual Wheel Central Locking Casters	Standard
Z-Q4	4" - Central Locking System <i>Increases seat height by 1".</i>	No Charge
Z-Q5	5" - Central Locking System <i>Increases seat height by 2".</i>	119

HEAT/MASSAGE OPTIONS (IEC 60601-1 CERTIFIED)

<i>Wand Controls</i>		
HW	Heat	1139
HMW	Heat & Massage	1369
<i>In-Arm Controls</i>		
H	Heat	849
HM	Heat & Massage	1119

ADDITIONAL FEATURES & OPTIONS

BBU	Battery Back Up	649
PB	Push Bar	Standard
EG	Protective Edge Guard	Standard
QR	Additional Quick Release Accessory Bracket	69
CAL	CAL TB133	See pg 9
Z	Multi Cover	Use Pricing for Highest Grade

PATIENT WELLNESS & COMFORT OPTIONS

ABP	Adjustable Back Pad (COM 1.75 yds)	
	Textile Grades COM-B	459
	Textile Grades C-I	569
AHP	Adjustable Head Rest Pillow (COM 1 yd)	339
DP	Dual IV Poles & Brackets ¹	498
FBH	Foley Bag Holder	89
IV	IV Pole & Bracket ¹	249
LC	LiquiCell	229
LCKFR	Orthopedic Locking Footrest	Standard
MBB	Moisture Barrier (Back)	59
MBS	Moisture Barrier (Seat)	59
MR	Monitor Arm (right side facing) ^{1,2}	849
MTR	Monitor Arm with Tray (right side facing) ^{1,2}	949
PR1	Paper Roll Holder ³	229
TE	Trendelenburg	Standard
USB	USB Power Outlet (IEC 60601-1 Certified)	459
WR	Wrist Restraint Mounts (pair)	229

TRAY TABLE OPTIONS

TSL1	Adjustable (Left) Side Tray, on Stationary Arm ^{1,5}	399
TSR167	Adjustable (Right) Side Tray, on Fold Down Arm ^{1,5}	449

FOLD DOWN TRANSFER ARM SPECIFIC

HC	Hinge Cover	Standard
----	-------------	----------

Refer to pg 107 for full option details and images

¹Includes QR bracket connection installed on recliner

²Standard on right side (facing). Replace "R" with "L" for left side (facing) option where available.

³Takes place of Push Bar. Paper sold separately.

⁴Contact customer service for solid surface pricing

⁵Over the lap tray function recommended in seated position.

DURABLE® EXAM LIFT SERIES

Exam Lift Healthcare Recliner | Patient Transfer

Select Aesthetic Style (Denotes back & arm design)

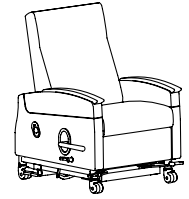
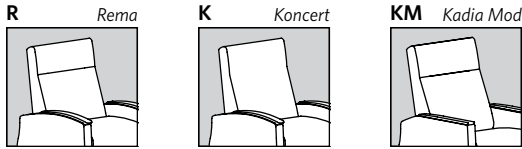

Functional Style (Aesthetic style code precedes selected model number below, e.g., KC7X67)

C7X62 Exam Lift Recliner - Infinite Position Locking Back - Dual Fold Down Arms

COM	Dillon/Carson	A ₅	B ₆	C ₇	D ₈	E ₉	F ₁₀	G ₁₁	H ₁₂	I ₁₃
14469	14739	14899	15099	15319	15529	15789	16129	16579	17109	17629

Dual Fold Down Arms
(Koncert style pictured)

Standard Features

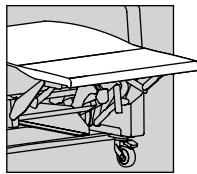

Chaise Continuous Leg Support

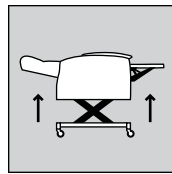

Raise to Exam Height via Non-Handed Foot Pedals

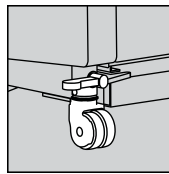

3" Dual Wheel Central Locking Caster System

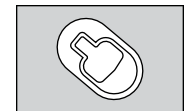

Locking Back Lever
(located on outside arm on applicable models)

Dimensions

	Overall			Seat			Back H	Arm H	Kick Out Seat D	Recline D	Distance from Wall
	W	D	H	W	D	H					
RC7X62 KC7X62	34.5	38	48	24	21	23	26	28	40	73	20
KMC7X62	34.5	38	48	24	21	23	26	28	40	73	20

General Info

COM: 7 yds
 Static Wt Cap: 650 lb
 Dynamic Wt Cap: 500 lb
 Unit Weight: 263 lb

Available Options

ARM CAP OPTIONS

See pg 2 for finishes

U	Urethane	Standard
J1	Solid Surface - Group 1	619
J2	Solid Surface - Group 2	819

CASTER OPTIONS

Z-Q3	3" - Dual Wheel Central Locking Casters	Standard
Z-Q4	4" - Central Locking System <i>Increases seat height by 1".</i>	No Charge
Z-Q5	5" - Central Locking System <i>Increases seat height by 2".</i>	119

HEAT/MASSAGE OPTIONS (IEC 60601-1 CERTIFIED)

<i>Wand Controls</i>		
HW	Heat	1139
HMW	Heat & Massage	1369

ADDITIONAL FEATURES & OPTIONS

BBU	Battery Back Up	649
PB	Push Bar	Standard
EG	Protective Edge Guard	Standard
QR	Additional Quick Release Accessory Bracket	69
CAL	CAL TB133	See pg 9
Z	Multi Cover	Use Pricing for Highest Grade

PATIENT WELLNESS & COMFORT OPTIONS

ABP	Adjustable Back Pad (COM 1.75 yds) Textile Grades COM-B	459
	Textile Grades C-I	569
AHP	Adjustable Head Rest Pillow (COM 1 yd)	339
DP	Dual IV Poles & Brackets ¹	498
FBH	Foley Bag Holder	89
IV	IV Pole & Bracket ¹	249
LC	LiquiCell	229
LCKFR	Orthopedic Locking Footrest	Standard
MBB	Moisture Barrier (Back)	59
MBS	Moisture Barrier (Seat)	59
MR	Monitor Arm (right side facing) ^{1,2}	849
MTR	Monitor Arm with tray (right side facing) ^{1,2}	949
PR1	Paper Roll Holder ³	229
TE	Trendelenburg	Standard
USB	USB Power Outlet (IEC 60601-1 Certified)	459
WR	Wrist Restraint Mounts (pair)	229

TRAY TABLE OPTIONS

TD362	Dual Adjustable Side Trays, on Fold Down Arms ^{1,5}	898
TSR167	Adjustable (Right) Side Tray, on Fold Down Arm ^{1,5}	449
TSL167	Adjustable (Left) Side Tray, on Fold Down Arm ^{1,5}	449

FOLD DOWN TRANSFER ARM SPECIFIC

HC	Hinge Cover	Standard
----	-------------	----------

Refer to pg 107 for full option details and images

¹Includes QR bracket connection installed on recliner

²Standard on right side (facing). Replace "R" with "L" for left side (facing) option where available.

³Takes place of Push Bar. Paper sold separately.

⁴Contact customer service for solid surface pricing

⁵Over the lap tray function recommended in seated position.

SLEEP SERIES

Sleep Chairs	160
Sofa & Bench	
Oxley Sleep Sofa	165
Oxley Sleep Bench	167
Max Sleep Sofa	168





General Product Information

- 600 lb Single / 1,000 Dual Chair Weight Capacity
- Three positions: Chair, Chaise, Bed
- Standard with 3" dual wheel casters
- Heavy duty steel pull-out bed mechanism
- Easy to open and close
- Bolsa™ Coil springs in cushion flex independently and adjust to optimize body contouring & support (not applicable on 46.5" seat width models)
- Field replaceable components

To Order, Specify

- Model Number
- Textile
- Finish
- Options

Available Options

ARM CAP OPTIONS		<i>See pg 2 for finishes</i>
U	Urethane	169
J1	Solid Surface - Group 1	619
J2	Solid Surface - Group 2	819
F	Fully Upholstered Arms	Standard
<i>*Harmony models standard with Urethane Arm Caps</i>		
ADDITIONAL FEATURES & OPTIONS		
CASTER	3" Dual Wheel Swivel Locking Casters	Standard
WF	Wood Legs	279
CAL	CAL TB133	See pg 9
Z	Multi Cover	Use Pricing for Highest Grade
MB	Moisture Barrier	See pg 11

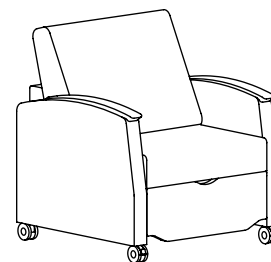

Sleep Chair - Chair Position

SLEEP SERIES

Sleep Chair | EV Style

E0700 - EV 32" Sleep Chair

Dimensions

Overall			Seat		
W	D	H	W	D	H
32	34.25	34.5	26.5	19.75	21
Sleep W	Sleep D	Back H	Arm H		
26.5	72	18.25	27.5		

COM: 7 yds
Wt Cap: 600 lb
Unit Weight: 158 lb

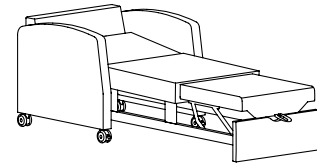

Pricing

COM	Dillon/Carson	A ₅	B ₆	C ₇	D ₈	E ₉	F ₁₀	G ₁₁	H ₁₂	I ₁₃
4489	4579	4819	5069	5389	5789	6139	6649	7999	8549	9079

E0800 - EV 36" Sleep Chair

Dimensions

Overall			Seat		
W	D	H	W	D	H
36	34.25	34.5	30.5	19.75	21
Sleep W	Sleep D	Back H	Arm H		
30.5	72	18.25	27.5		

COM: 9 yds
Wt Cap: 600 lb
Unit Weight: 188 lb

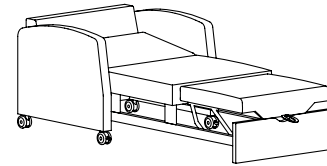

Pricing

COM	Dillon/Carson	A ₅	B ₆	C ₇	D ₈	E ₉	F ₁₀	G ₁₁	H ₁₂	I ₁₃
4639	4859	5159	5469	5919	6509	7089	7829	8749	9579	10399

E0900 - EV 52" Sleep Chair

Dimensions

Overall			Seat		
W	D	H	W	D	H
52	34.25	34.5	46.5	19.75	21
Sleep W	Sleep D	Back H	Arm H		
46.5	72	18.25	27.5		

COM: 10 yds
Wt Cap: 600 lb
Unit Weight: 228 lb

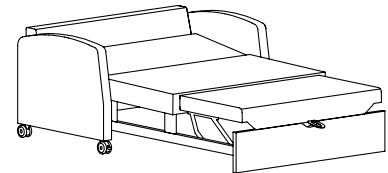

Pricing

COM	Dillon/Carson	A ₅	B ₆	C ₇	D ₈	E ₉	F ₁₀	G ₁₁	H ₁₂	I ₁₃
5859	6029	6349	6749	7079	7659	8239	9009	10009	10789	11579

E0722 - EV 59" Dual Sleep Chair

Dimensions

Overall			Seat		
W	D	H	W	D	H
59	32	36.25	27.12	19	19.5
Sleep W	Sleep D	Back H	Arm H		
27.13	72	18.25	27.5		

COM: 12 yds
Wt Cap: 1000 lb
Unit Weight: 264 lb

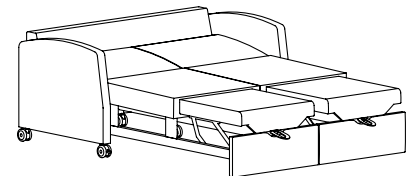

Pricing

COM	Dillon/Carson	A ₅	B ₆	C ₇	D ₈	E ₉	F ₁₀	G ₁₁	H ₁₂	I ₁₃
7439	7719	8139	8669	9079	9889	10489	11319	11889	13159	14209

Available Options

ARM CAP OPTIONS		See pg 2 for finishes
U	Urethane	169
J1	Solid Surface - Group 1	619
J2	Solid Surface - Group 2	819
F	Fully Upholstered Arms	Standard

ADDITIONAL FEATURES & OPTIONS		
CASTER	3" Dual Wheel Swivel Locking Casters	Standard
WF	Wood Legs	279
CAL	CAL TB133	See pg 9
Z	Multi Cover	Use Pricing for Highest Grade
MB	Moisture Barrier	See pg 11

SLEEP SERIES

Sleep Chair | Rema Style

R1700 - Rema 33" Sleep Chair

Dimensions

Overall			Seat		
W	D	H	W	D	H
33	34.25	34.5	26.5	19.75	21
Sleep W	Sleep D	Back H	Arm H		
26.5	72	18.25	27.5		

COM: 7 yds
Wt Cap: 600 lb
Unit Weight: 158 lb

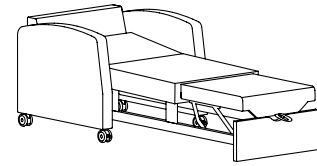

Pricing

COM	Dillon/Carson	A ₅	B ₆	C ₇	D ₈	E ₉	F ₁₀	G ₁₁	H ₁₂	I ₁₃
4489	4579	4819	5069	5389	5789	6139	6649	7999	8549	9079

R1800 - Rema 37" Sleep Chair

Dimensions

Overall			Seat		
W	D	H	W	D	H
37	34.25	34.5	30.5	19.75	21
Sleep W	Sleep D	Back H	Arm H		
30.5	72	18.25	27.5		

COM: 9 yds
Wt Cap: 600 lb
Unit Weight: 189 lb

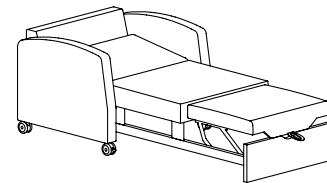

Pricing

COM	Dillon/Carson	A ₅	B ₆	C ₇	D ₈	E ₉	F ₁₀	G ₁₁	H ₁₂	I ₁₃
4639	4859	5159	5469	5919	6509	7089	7829	8749	9579	10399

R1900 - Rema 53" Sleep Chair

Dimensions

Overall			Seat		
W	D	H	W	D	H
53	34.25	34.5	46.5	19.75	21
Sleep W	Sleep D	Back H	Arm H		
46.5	72	18.25	27.5		

COM: 10 yds
Wt Cap: 600 lb
Unit Weight: 229 lb

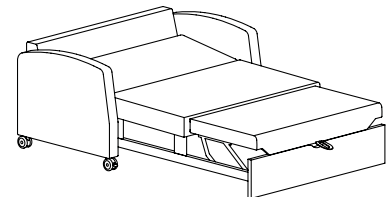

Pricing

COM	Dillon/Carson	A ₅	B ₆	C ₇	D ₈	E ₉	F ₁₀	G ₁₁	H ₁₂	I ₁₃
5699	6029	6349	6749	7079	7659	8239	9009	10009	10789	11579

R1722 - Rema 60" Dual Sleep Chair

Dimensions

Overall			Seat		
W	D	H	W	D	H
60	32	36.25	27.125	19	19.75
Sleep W	Sleep D	Back H	Arm H		
27.13	72	18.25	27.5		

COM: 12 yds
Wt Cap: 1000 lb
Unit Weight: 264 lb

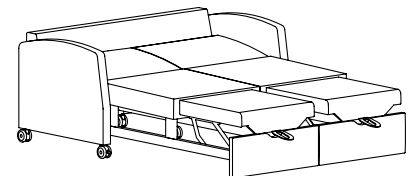

Pricing

COM	Dillon/Carson	A ₅	B ₆	C ₇	D ₈	E ₉	F ₁₀	G ₁₁	H ₁₂	I ₁₃
7439	7719	8139	8669	9079	9889	10489	11319	11889	13159	14209

Available Options

ARM CAP OPTIONS		See pg 2 for finishes
U	Urethane	169
J1	Solid Surface - Group 1	619
J2	Solid Surface - Group 2	819
F	Fully Upholstered Arms	Standard

ADDITIONAL FEATURES & OPTIONS		
CASTER	3" Dual Wheel Swivel Locking Casters	Standard
WF	Wood Legs	279
CAL	CAL TB133	See pg 9
Z	Multi Cover	Use Pricing for Highest Grade
MB	Moisture Barrier	See pg 11

SLEEP SERIES

Sleep Chair | Kadia Mod Style

KM1700 - Kadia Mod 33" Sleep Chair

Dimensions

Overall			Seat		
W	D	H	W	D	H
33	32	34.5	26.5	19.75	19.75
Sleep W	Sleep D	Back H	Arm H		
26.5	72	18.25	27		

COM: 7 yds
 Wt Cap: 600 lb
 Unit Weight: 160 lb

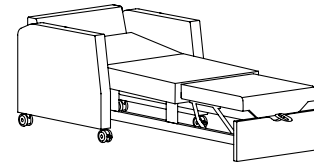

Pricing

COM	Dillon/Carson	A ₅	B ₆	C ₇	D ₈	E ₉	F ₁₀	G ₁₁	H ₁₂	I ₁₃
4489	4579	4819	5069	5389	5789	6139	6649	7999	8549	9079

KM1800 - Kadia Mod 37" Sleep Chair

Dimensions

Overall			Seat		
W	D	H	W	D	H
37	32	34.5	30.5	19.75	19.75
Sleep W	Sleep D	Back H	Arm H		
30.5	72	18.25	27		

COM: 9 yds
 Wt Cap: 600 lb
 Unit Weight: 189 lb

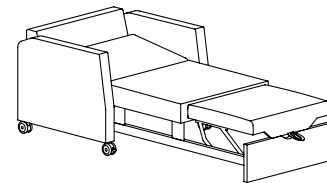

Pricing

COM	Dillon/Carson	A ₅	B ₆	C ₇	D ₈	E ₉	F ₁₀	G ₁₁	H ₁₂	I ₁₃
4639	4859	5159	5469	5919	6509	7089	7829	8749	9579	10399

KM1900 - Kadia Mod 53" Sleep Chair

Dimensions

Overall			Seat		
W	D	H	W	D	H
53	32	34.5	46.5	19.75	19.75
Sleep W	Sleep D	Back H	Arm H		
46.5	72	18.25	27		

COM: 10 yds
 Wt Cap: 600 lb
 Unit Weight: 229 lb

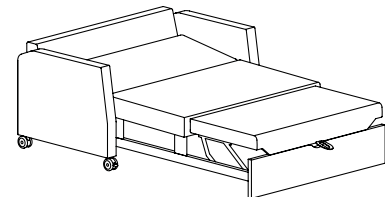

Pricing

COM	Dillon/Carson	A ₅	B ₆	C ₇	D ₈	E ₉	F ₁₀	G ₁₁	H ₁₂	I ₁₃
5699	6029	6349	6749	7079	7659	8239	9009	10009	10789	11579

KM1722 - Kadia Mod 60" Dual Sleep Chair

Dimensions

Overall			Seat		
W	D	H	W	D	H
60	32	34.25	27.125	19.75	19.75
Sleep W	Sleep D	Back H	Arm H		
27.13	72	18.25	27		

COM: 12 yds
 Wt Cap: 1000 lb
 Unit Weight: 264 lb

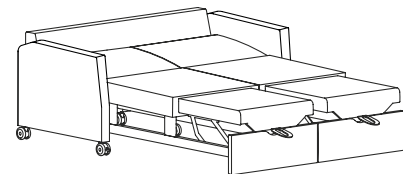

Pricing

COM	Dillon/Carson	A ₅	B ₆	C ₇	D ₈	E ₉	F ₁₀	G ₁₁	H ₁₂	I ₁₃
7439	7719	8139	8669	9079	9889	10489	11319	11889	13159	14209

Available Options

ARM CAP OPTIONS		See pg 2 for finishes
U	Urethane	169
J1	Solid Surface - Group 1	619
J2	Solid Surface - Group 2	819
F	Fully Upholstered Arms	Standard

ADDITIONAL FEATURES & OPTIONS		
CASTER	3" Dual Wheel Swivel Locking Casters	Standard
WF	Wood Legs	279
CAL	CAL TB133	See pg 9
Z	Multi Cover	Use Pricing for Highest Grade
MB	Moisture Barrier	See pg 11

SLEEP SERIES

Sleep Chair | Harmony Style

H1700 - Harmony 34" Sleep Chair

Dimensions

Overall			Seat		
W	D	H	W	D	H
34	34.25	34.5	26.5	21	26.5
Sleep W	Sleep D	Back H	Arm H		
26	72	18.25	27.25		

COM: 7 yds
 Wt Cap: 600 lb
 Unit Weight: 173 lb

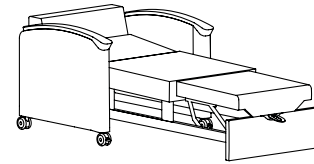

Pricing

COM	Dillon/Carson	A ₅	B ₆	C ₇	D ₈	E ₉	F ₁₀	G ₁₁	H ₁₂	I ₁₃
4739	4959	5169	5349	5679	6109	6509	7029	8159	8689	9339

H1800 - Harmony 38" Sleep Chair

Dimensions

Overall			Seat		
W	D	H	W	D	H
38	34.25	34.5	30.5	19.75	21
Sleep W	Sleep D	Back H	Arm H		
30	72	18.25	27.25		

COM: 9 yds
 Wt Cap: 600 lb
 Unit Weight: 200 lb

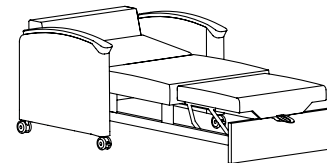

Pricing

COM	Dillon/Carson	A ₅	B ₆	C ₇	D ₈	E ₉	F ₁₀	G ₁₁	H ₁₂	I ₁₃
4859	5099	5519	5849	6359	6809	7399	8209	8909	9479	10259

H1900 - Harmony 54" Sleep Chair

Dimensions

Overall			Seat		
W	D	H	W	D	H
54	34.25	34.5	46.5	19.75	21
Sleep W	Sleep D	Back H	Arm H		
46	72	18.25	27.25		

COM: 10 yds
 Wt Cap: 600 lb
 Unit Weight: 229 lb

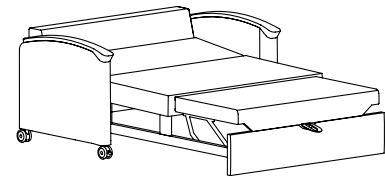

Pricing

COM	Dillon/Carson	A ₅	B ₆	C ₇	D ₈	E ₉	F ₁₀	G ₁₁	H ₁₂	I ₁₃
6209	6379	6769	7209	7709	8339	8979	9809	10199	10999	11699

Available Options

ARM CAP OPTIONS		See pg 2 for finishes
U	Urethane (black only in Harmony style)	Standard

ADDITIONAL FEATURES & OPTIONS		
CASTER	3" Dual Wheel Swivel Locking Casters	Standard
WF	Wood Legs	279
CAL	CAL TB133	See pg 9
Z	Multi Cover	Use Pricing for Highest Grade
MB	Moisture Barrier	See pg 11





General Product Information

- 1,000 lb Weight Capacity
- Sofa and bench styles available
- Front panel pulls out and seat folds over to reveal sleep surface
- Standard with 3" dual wheel casters
- Separate seat and sleep surfaces
- Blue sleep surface material is anti-microbial, bleach cleanable, and moisture resistant
- 24" needed in front of unit to pull out sleep extension

To Order, Specify

- Model Number
- Textile
- Finish
- Options

Available Options

ARM CAP OPTIONS

See pg 2 for finishes

		OO Model	OW Model
U	Urethane	169	229
J1	Solid Surface - Group 1	619	1139
J2	Solid Surface - Group 2	819	1399
T	Thermofoil	139	229
F	Fully Upholstered Arms	Standard	Standard

POWER OPTIONS

POWER	Hospital Grade Power (USB-A/USB-C/120 V Outlet) <i>*Available on OW2176UF only.</i>	569
-------	---	-----

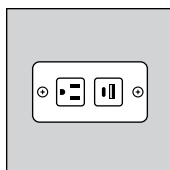

ADDITIONAL FEATURES & OPTIONS

CASTER	3" Dual Wheel Swivel Locking Casters	Standard
CAL	CAL TB133	See pg 9
Z	Multi Cover	Use Pricing for Highest Grade
MB	Moisture Barrier	See pg 11

SLEEP SERIES

Oxley | Sleep Sofa

ON2176UF - Oxley Pullout Sleep Sofa - Armless

Dimensions

Overall			Seat		
W	D**	H	W	D	H
76	31	36	76	20	20.5
Sleep W	Sleep D	Back H	Arm H		
75	45	15.5	n/a		

COM: 8 yds
 Wt Cap: 1000 lb
 Unit Weight: 207 lb

**Total Depth is 53" when sleep surface pulled out

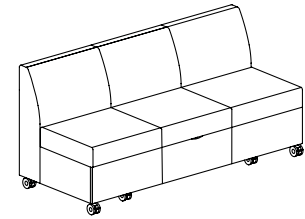

Pricing

COM	Dillon/Carson	A ₅	B ₆	C ₇	D ₈	E ₉	F ₁₀	G ₁₁	H ₁₂	I ₁₃
6229	6259	6739	7069	7219	7369	7989	8519	9299	9949	10529

OO2176UF - Oxley Pullout Sleep Sofa - 3.5" Wide Square Arms

Dimensions

Overall			Seat		
W	D**	H	W	D	H
82	31	36	76	22	20.5
Sleep W	Sleep D	Back H	Arm H		
75	45	15.5	27.75		

COM: 10.5 yds
 Wt Cap: 1000 lb
 Unit Weight: 264 lb

**Total Depth is 53" when sleep surface pulled out

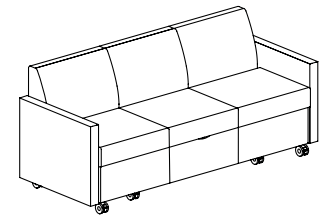

Pricing

COM	Dillon/Carson	A ₅	B ₆	C ₇	D ₈	E ₉	F ₁₀	G ₁₁	H ₁₂	I ₁₃
6869	6999	7219	7719	8019	8519	8989	9639	10579	11319	12099

OW2176UF - Oxley Pullout Sleep Sofa - 5" Wide Square Arms

Dimensions

Overall			Seat		
W	D**	H	W	D	H
85.5	31	36	76	22	20.5
Sleep W	Sleep D	Back H	Arm H		
74	45	15.5	21.75		

COM: 10.5 yds
 Wt Cap: 1000 lb
 Unit Weight: 265 lb

**Total Depth is 53" when sleep surface pulled out

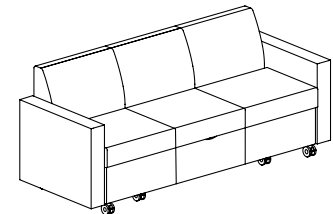

Pricing

COM	Dillon/Carson	A ₅	B ₆	C ₇	D ₈	E ₉	F ₁₀	G ₁₁	H ₁₂	I ₁₃
6869	6999	7219	7719	8019	8519	8989	9639	10579	11319	12099

OC2176UF - Oxley Pullout Sleep Sofa - Lounge Arms

Dimensions

Overall			Seat		
W	D**	H	W	D	H
91	31	36	76	22	20.5
Sleep W	Sleep D	Back H	Arm H		
74	45	15.5	36		

COM: 11.75 yds
 Wt Cap: 1000 lb
 Unit Weight: 268 lb

*Solid textile pattern must be used on back & arms.

**Total Depth is 53" when sleep surface pulled out

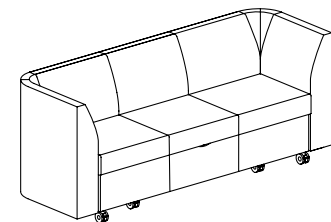

Pricing

COM	Dillon/Carson	A ₅	B ₆	C ₇	D ₈	E ₉	F ₁₀	G ₁₁	H ₁₂	I ₁₃
7369	7899	8159	8419	8759	9209	9599	10129	10969	11969	12899

Available Options

ARM CAP OPTIONS

See pg 2 for finishes

	OO Model	OW Model
U Urethane	169	229
J1 Solid Surface - Group 1	619	1139
J2 Solid Surface - Group 2	819	1399
T Thermofoil	139	229
F Fully Upholstered Arms	Standard	Standard

ADDITIONAL FEATURES & OPTIONS

CASTER	3" Dual Wheel Swivel Locking Casters	Standard
POWER	Hospital Grade Power Outlet ¹	569
CAL	CAL TB133	See pg 9
Z	Multi Cover	Use Pricing for Highest Grade
MB	Moisture Barrier	See pg 11

¹Available on OW2176UF only. (2) USB Ports, (1) 120 V Power Outlet

SLEEP SERIES

Oxley | Sleep Bench

ON2076UF - Oxley Pullout Sleep Bench

Dimensions

Overall			Seat		
W	D**	H	W	D	H
76	24	24.625	76	20	20.5
Sleep W	Sleep D	Back H	Arm H		
75	39.5	3	n/a		

COM: 6 yds
 Wt Cap: 1000 lb
 Unit Weight: 181 lb

**Total Depth is 43" when sleep surface pulled out

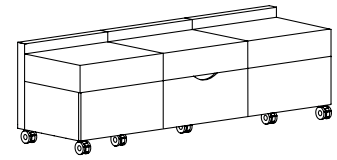

Pricing

COM	Dillon/Carson	A ₅	B ₆	C ₇	D ₈	E ₉	F ₁₀	G ₁₁	H ₁₂	I ₁₃
4849	4869	4979	5119	5299	5549	5799	6089	6579	7099	7629

ON2076HPUF - Oxley High Back Pullout Sleep Bench with Back Pad

Dimensions

Overall			Seat		
W	D**	H	W	D	H
76	24	36	76	20	20.5
Sleep W	Sleep D	Back H	Arm H		
75	39.5	15.5	n/a		

COM: 8.5 yds
 Wt Cap: 1000 lb
 Unit Weight: 207 lb

**Total Depth is 43" when sleep surface pulled out

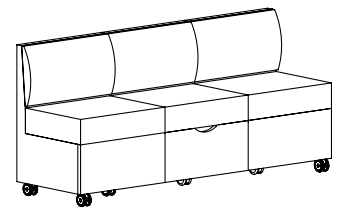

Pricing

COM	Dillon/Carson	A ₅	B ₆	C ₇	D ₈	E ₉	F ₁₀	G ₁₁	H ₁₂	I ₁₃
6479	6519	6599	6819	7069	7319	7569	7969	8429	9199	9869

Available Options

ADDITIONAL FEATURES & OPTIONS

CASTER	3" Dual Wheel Swivel Locking Casters	Standard
CAL	CAL TB133	See pg 9
Z	Multi Cover	Use Pricing for Highest Grade
MB	Moisture Barrier	See pg 11



General Product Information

- 1,000 lb Weight Capacity
- Back cushion folds down to reveal sleep surface
- Customizable with recliner footrests, drawers, tables, and more
- Separate seat and sleep surfaces
- Blue sleep surface material is anti-microbial, bleach cleanable, and moisture resistant
- Size footprint remains same when converted to sleep position
- Standard with wood legs

To Specify, See Product Builder on Following Pages

Visual Option Guide

This page illustrates the choices available to customize the Max Sleep Sofa to your specific needs. The following pages include pricing and a table to guide you in building a product model number based on your selected specifications.

The Max Sleep Sofa is available in two (2) standard seat widths: 78" and 70".

ARM STYLES

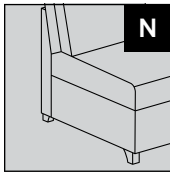

Armless

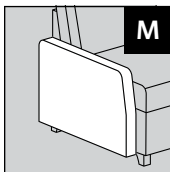

3" Arm

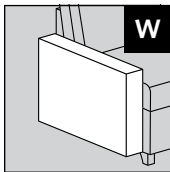

5" Arm

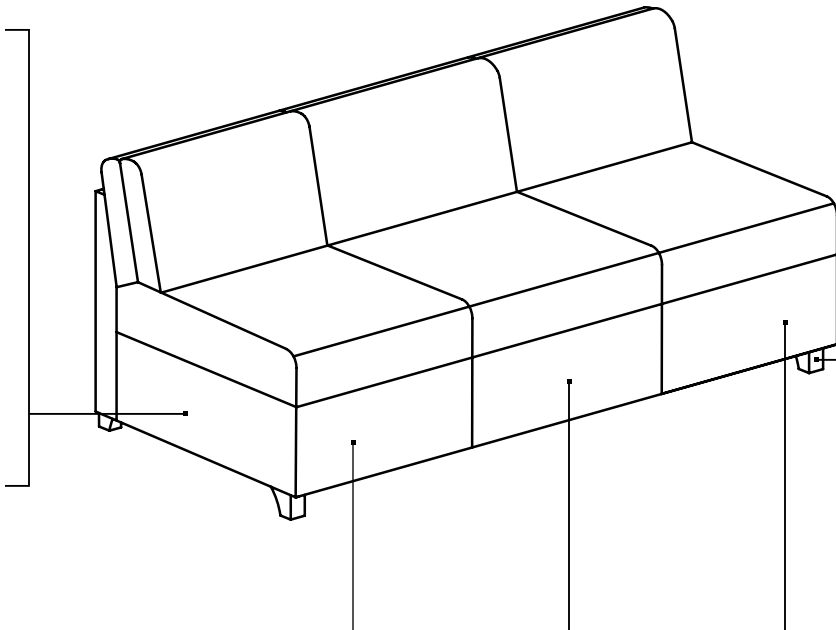

LEG OPTIONS

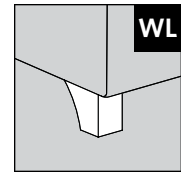

Wood Legs

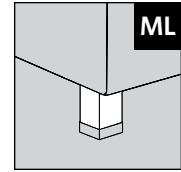

Metal Legs

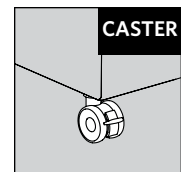

3" Swivel Locking Casters

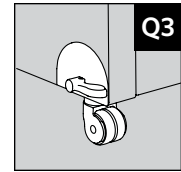

3" Central Locking Caster System

ARM CAPS

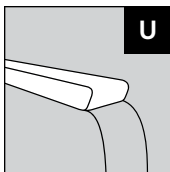

Urethane

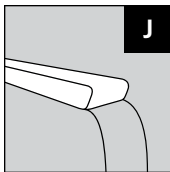

Solid Surface

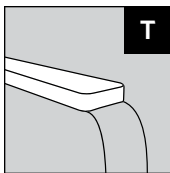

Thermofoil

POWER

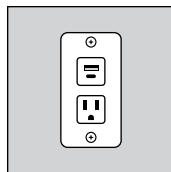

Hospital Grade Power

LEFT SIDE

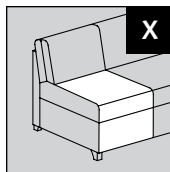

Fixed Front

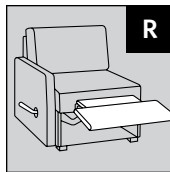

Recliner Leg Rest

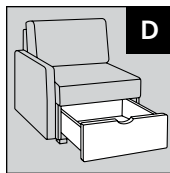

Drawer

CENTER

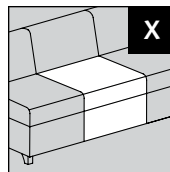

Fixed Front

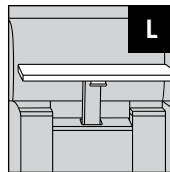

Lift Table

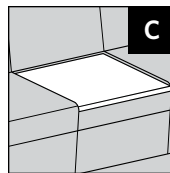

Console Table

RIGHT SIDE

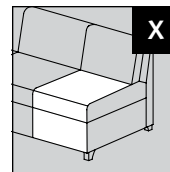

Fixed Front

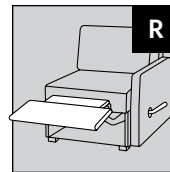

Recliner Leg Rest

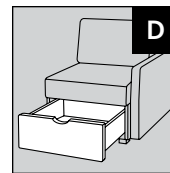

Drawer

Base Model & Arm Pricing

Select base pricing below dependent on your selection of 78" seat width (N78XXXUF) or 70" seat width (N70XXXUF), and selected textile grade. If 3" arms or 5" arms are selected, use the chart below to find the upcharge based on textile grade.

Base models are standard with upholstered fixed front, wood legs, and no arms. Selections made on the following page will affect the model number and list price.

N78XXXUF - 78" Seat Width Base Sofa

Dimensions

Overall			Seat		
W	D	H	W	D	H
78	35	36	78	22	20
			Back H	Arm H	
			15	n/a	

COM: 8 yds*
 Wt Cap: 1000 lb
 Unit Weight: 175 lb**

*See table (below right) for additional COM info
 **Weight will vary based on selected options

Pricing

COM	Dillon/Carson	A ₅	B ₆	C ₇	D ₈	E ₉	F ₁₀	G ₁₁	H ₁₂	I ₁₃
5089	5229	5499	5869	6179	6599	7019	7339	7939	8549	9199

Arm Pricing (per pair)

	3" Arms	5" Arms
COM	259	439
Dillon/Carson	309	489
A ₅	429	589
B ₆	559	729
C ₇	629	789
D ₈	779	959
E ₉	799	979
F ₁₀	919	1089
G ₁₁	939	1119
H ₁₂	1189	1449
I ₁₃	1459	1589

N70XXXUF - 70" Seat Width Base Sofa (Not available with drawer or recliner leg rest options)

Dimensions

Overall			Seat		
W	D	H	W	D	H
70	35	36	70	22	20
			Back H	Arm H	
			15	n/a	

COM: 8 yds*
 Wt Cap: 1000 lb
 Unit Weight: 173 lb**

*See table (below right) for additional COM info
 **Weight will vary based on selected options

Pricing

COM	Dillon/Carson	A ₅	B ₆	C ₇	D ₈	E ₉	F ₁₀	G ₁₁	H ₁₂	I ₁₃
4929	5069	5329	5709	6009	6429	6809	7119	7709	8419	8949

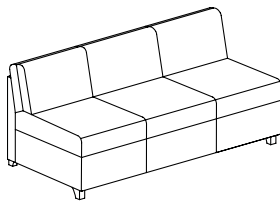

N78XXXUF
78" Base Sofa

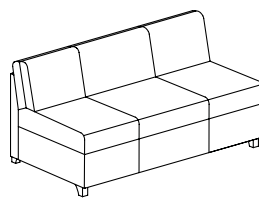

N70XXXUF
70" Base Sofa

For COM orders, add the below yardage for options selected.

- 3" or 5" Arms (pair): +1.2 yds
- Recliner Leg Rest (each): +0.5 yds
- Drawer (each): +0.5 yds
- Lift or Console Table: +0.6 yds

Build Model Number by Selecting One Option from Each Column

Specify any additional options, along with textile/s and finishes. Add associated list prices from your selections below to the base model price on the previous page.

EXAMPLE

1. Arm Style

Choose from
N or M or W

M

3" Arms

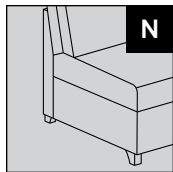

Armless

See pricing table on previous page

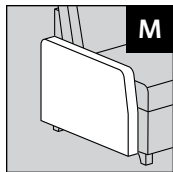

3" Arm

See pricing table on previous page

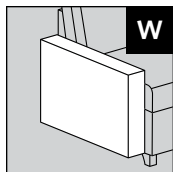

5" Arm

See pricing table on previous page

2. Seat Width

Choose from
78 or 70

78

78" Seat Width

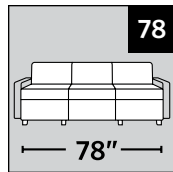

78" Seat Width

See base pricing on previous page

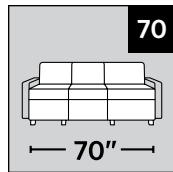

70" Seat Width

See base pricing on previous page

3. Left Side

Choose from
X or R or D

R

Recliner Leg Rest
(Left side facing)

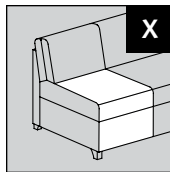

Fixed Front

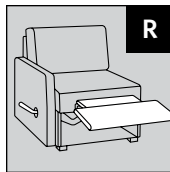

Recliner Leg Rest

+649

Available on 78" models with 3" arms only. Choose UF for selection #6 (front style).

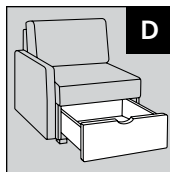

Drawer

Upholstered +1129
Thermofoil +1299

Drawers available on 78" models only.

4. Center

Choose from
X or L or C

L

Lift Table

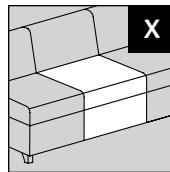

Fixed Front

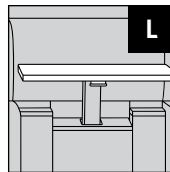

Lift Table

Thermofoil +2789

Solid Surface

Group 1 +4019

Group 2 +4219

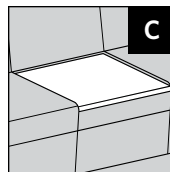

Console Table

Thermofoil +819

Solid Surface

Group 1 +2249

Group 2 +2449

5. Right Side

Choose from
X or R or D

R

Recliner Leg Rest
(Right side facing)

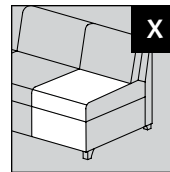

Fixed Front

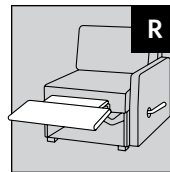

Recliner Leg Rest

+649

Available on 78" models with 3" arms only. Choose UF for selection #6 (front style).

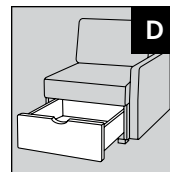

Drawer

Upholstered +1129

Thermofoil +1299

Drawers available on 78" models only.

6. Front Style

Choose from**
UF or LF

UF

Upholstered Front

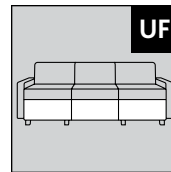

Upholstered Front

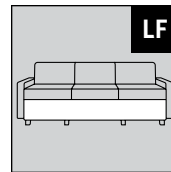

Thermofoil Front

Full Front +339
Single Section +169

If (D) Drawer option selected, choose from **UD for Upholstered **LD** for Thermofoil

Available Options

ARM CAP OPTIONS

See pg 2 for finishes

	3" Arms	5" Arms
U Urethane	169	229
J1 Solid Surface - Group 1	619	1139
J2 Solid Surface - Group 2	819	1399
T Thermofoil	139	229
F Fully Upholstered Arms	Standard	Standard

CASTER & LEG OPTIONS

WL Wood Legs	Standard
ML Metal Legs	279
CASTER Q3 3" - Dual Wheel Swivel Locking Casters	199
Q3 3" - Dual Wheel Central Locking Caster System ¹	1019

ADDITIONAL FEATURES & OPTIONS

POWER Hospital Grade Power Outlet ²	569
CAL CAL TB133	See pg 9
Z Multi Cover	Use Pricing for Highest Grade
MB Moisture Barrier	See pg 11

Power Placement:

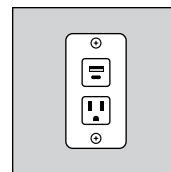

If Lift Table selected-
left side of inner console

If 5" Arms selected (and no Lift Table)-
left (facing) arm

If neither 5" Arms or Lift Table selected-
front center of fixed front

¹Not available when recliner or drawer selected

²(2) USB Ports, (1) 120 V Power Outlet



Mailing Address

P.O. Box 9
Ferdinand, IN 47532

getknu.com

Contact Us

812.367.2068
customerservice@getknu.com

Follow @GetKnu

