

# Kadia Mod Visitor Seating

## Standard Product Information

- Passive Flex Back
- Clean-out between Seat and Back
- High Quality Comfort Webbing in Guest Seats
- 16 Gauge Steel Frame
- Molded Seat Foam
- 1.7 Density Back Foam TB117-2013
- Heavy Steel Rails Connect Arms and Seats
- Field Replaceable Components
- Wall-Saver Leg Design
- Adjustable Glides

## Dimensions

- |                               |         |
|-------------------------------|---------|
| ▪ Width (Guest)               | 24.5"   |
| ▪ Width (Bariatric)           | 33.5"   |
| ▪ Depth                       | 31"     |
| ▪ Height                      | 34"     |
| ▪ Seat Width (Guest)          | 20.75"  |
| ▪ Seat Width (Bariatric)      | 29.5"   |
| ▪ Weight Capacity (Guest)     | 550 lbs |
| ▪ Weight Capacity (Bariatric) | 750 lbs |



## Featuring a Modified Arm Design

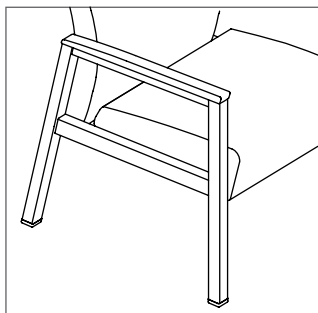

## Wood and Urethane Arm Cap Finishes

Please refer to page 14.

## Powder Coat Frame Finishes

Standard color is 540 Pewter. 211 Silver Frost is also available upon request. For other metal powder coat finishes, please contact Customer Service at [customerservice@getknu.com](mailto:customerservice@getknu.com).

## Solid Surface Arm Cap Options

Solid Surface Arm Cap standard is Corian® Terra Collection in Antarctica. Please contact Customer Service for pricing and availability of non-standard colors.

## CAL TB133

Please refer to page 12.

## Moisture Barrier Options

Please refer to page 14.

**TO ORDER, SPECIFY**

- 1. Model Number                      3. Finish
- 2. Textile                                4. Options

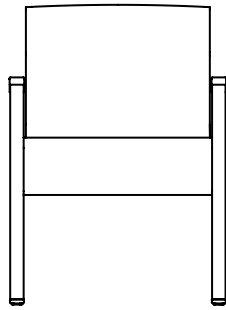

**KAM10 - GUEST CHAIR WITH ARM CAPS**

**DIMENSIONS**

Width	24.5	Seat Width	20.75	Back Height	15
Depth	28.5	Seat Depth	19.5	Arm Height	25.5
Height	33.25	Seat Height	18.25	Weight	45
COM	2 YDS				

**PRICING WITH URETHANE ARM CAPS - KAM10U**

COM	4	5	6	7	8	9	10	11
1239	1259	1309	1339	1389	1449	1489	1559	1709

**PRICING WITH WOOD ARM CAPS - KAM10W**

COM	4	5	6	7	8	9	10	11
1239	1259	1309	1339	1389	1449	1489	1559	1709

**PRICING WITH SOLID SURFACE ARM CAPS - KAM10J**

COM	4	5	6	7	8	9	10	11
1759	1779	1819	1849	1909	1969	2009	2069	2219

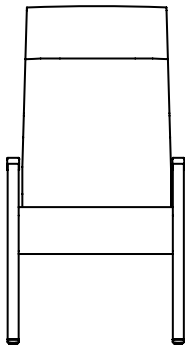
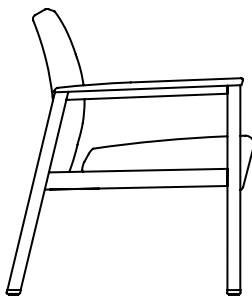

**KAM10H - HIGH BACK GUEST CHAIR WITH ARM CAPS**

**DIMENSIONS**

Width	24.5	Seat Width	20.75	Back Height	26.75
Depth	28.5	Seat Depth	19	Arm Height	25.5
Height	45.5	Seat Height	18.25	Weight	50
COM	2 YDS				

**PRICING WITH URETHANE ARM CAPS - KAM10HU**

COM	4	5	6	7	8	9	10	11
1449	1459	1499	1529	1589	1649	1689	1759	1909

**PRICING WITH WOOD ARM CAPS - KAM10HW**

COM	4	5	6	7	8	9	10	11
1449	1459	1499	1529	1589	1649	1689	1759	1909

**PRICING WITH SOLID SURFACE ARM CAPS - KAM10HJ**

COM	4	5	6	7	8	9	10	11
1969	1979	2019	2049	2099	2159	2199	2279	2419

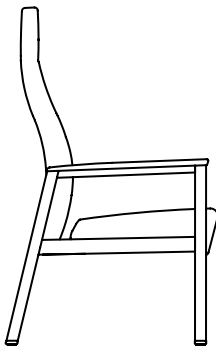

**TO ORDER, SPECIFY**

- 1. Model Number      3. Finish
- 2. Textile              4. Options

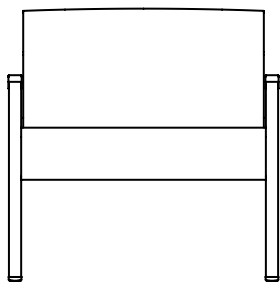

**KAM10B - BARIATRIC GUEST CHAIR WITH ARM CAPS**

**DIMENSIONS**

Width	33.5	Seat Width	29.5	Back Height	15
Depth	28.5	Seat Depth	19.5	Arm Height	25.5
Height	33.25	Seat Height	18.25	Weight	65
COM	3 YDS				

**PRICING WITH URETHANE ARM CAPS - KAM10BU**

COM	4	5	6	7	8	9	10	11
1489	1519	1589	1659	1719	1819	1899	1989	2149

**PRICING WITH WOOD ARM CAPS - KAM10BW**

COM	4	5	6	7	8	9	10	11
1489	1519	1589	1659	1719	1819	1899	1989	2149

**PRICING WITH SOLID SURFACE ARM CAPS - KAM10BJ**

COM	4	5	6	7	8	9	10	11
2029	2059	2109	2179	2249	2339	2429	2499	2659

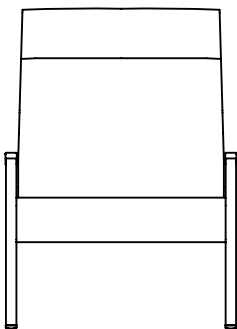
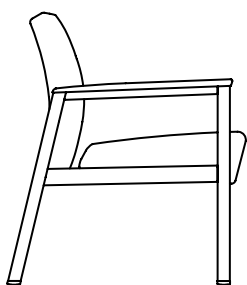

**KAM10BH - BARIATRIC HIGH BACK GUEST CHAIR WITH ARM CAPS**

**DIMENSIONS**

Width	33.5	Seat Width	29.5	Back Height	26.75
Depth	28.5	Seat Depth	19	Arm Height	25.5
Height	33.25	Seat Height	18.25	Weight	72
COM	3.5 YDS				

**PRICING WITH URETHANE ARM CAPS - KAM10BHU**

COM	4	5	6	7	8	9	10	11
1869	1989	2079	2169	2229	2359	2479	2589	2789

**PRICING WITH WOOD ARM CAPS - KAM10BHW**

COM	4	5	6	7	8	9	10	11
1869	1989	2079	2169	2229	2359	2479	2589	2789

**PRICING WITH SOLID SURFACE ARM CAPS - KAM10BHJ**

COM	4	5	6	7	8	9	10	11
2409	2519	2599	2699	2749	2889	2999	3139	3289

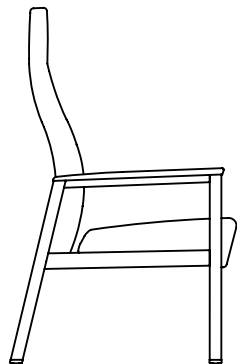

**TO ORDER, SPECIFY**

- 1. Model Number                      3. Finish
- 2. Textile                                4. Options

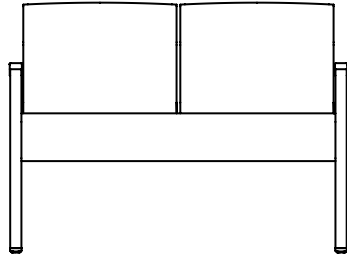

**KAM20 - 2 SEAT GUEST CHAIR WITH ARM CAPS**

**DIMENSIONS**

Width	45.5	Seat Width	42	Back Height	15
Depth	28.5	Seat Depth	19.5	Arm Height	25.5
Height	33.25	Seat Height	18.25	Weight	79
COM	3 YDS				

**PRICING WITH URETHANE ARM CAPS - KAM20U**

COM	4	5	6	7	8	9	10	11
1989	2029	2099	2169	2239	2349	2439	2519	2659

**PRICING WITH WOOD ARM CAPS - KAM20W**

COM	4	5	6	7	8	9	10	11
1989	2029	2099	2169	2239	2349	2439	2519	2659

**PRICING WITH SOLID SURFACE ARM CAPS - KAM20J**

COM	4	5	6	7	8	9	10	11
2529	2569	2619	2699	2759	2879	2959	3029	3159

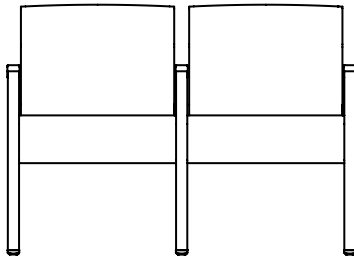
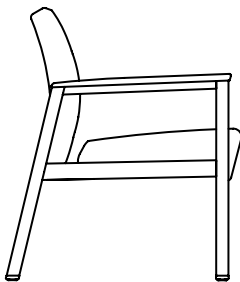

**KAM20I - 2 SEAT GUEST CHAIR WITH ARM CAPS, INTERVENING ARM**

**DIMENSIONS**

Width	47	Seat Width	20.75	Back Height	15
Depth	28.5	Seat Depth	19.5	Arm Height	25.5
Height	33.25	Seat Height	18.25	Weight	82
COM	3 YDS				

**PRICING WITH URETHANE ARM CAPS - KAM20IU**

COM	4	5	6	7	8	9	10	11
2239	2279	2349	2409	2509	2589	2699	2769	2969

**PRICING WITH WOOD ARM CAPS - KAM20IW**

COM	4	5	6	7	8	9	10	11
2239	2279	2349	2409	2509	2589	2699	2769	2969

**PRICING WITH SOLID SURFACE ARM CAPS - KAM20IJ**

COM	4	5	6	7	8	9	10	11
3039	3079	3139	3199	3299	3379	3489	3539	3729

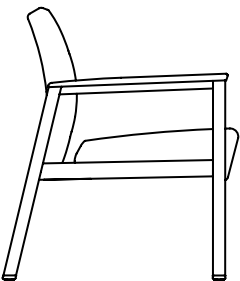

**TO ORDER, SPECIFY**

- 1. Model Number
- 2. Textile
- 3. Finish
- 4. Options

**KAM20IBL - 2 SEAT GUEST CHAIR WITH ARM CAPS, 29.5" LEFT FACING BARIATRIC, INTERVENING ARM**

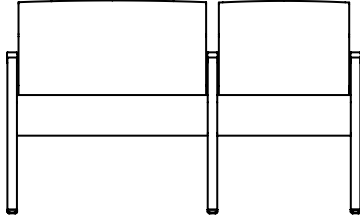

**DIMENSIONS**

Width	58	Seat Width	29.5	Back Height	15
Depth	28.5	Seat Depth	19.5	Arm Height	25.5
Height	33.25	Seat Height	18.25	Weight	87
COM	3.5 YDS				

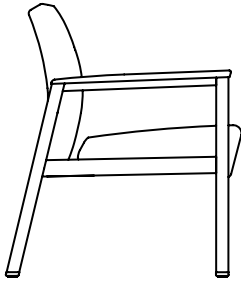

**PRICING WITH URETHANE ARM CAPS - KAM20IBLU**

COM	4	5	6	7	8	9	10	11
2559	2579	2659	2739	2829	2939	3079	3169	3349

**PRICING WITH WOOD ARM CAPS - KAM20IBLW**

COM	4	5	6	7	8	9	10	11
2559	2579	2659	2739	2829	2939	3079	3169	3349

**PRICING WITH SOLID SURFACE ARM CAPS - KAM20IBLJ**

COM	4	5	6	7	8	9	10	11
3359	3379	3439	3529	3619	3729	3859	3939	4109

**KAM20IBR - 2 SEAT GUEST CHAIR WITH ARM CAPS, 29.5" RIGHT FACING BARIATRIC, INTERVENING ARM**

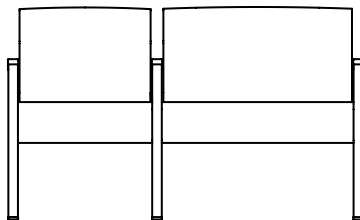

**DIMENSIONS**

Width	58	Seat Width	29.5	Back Height	15
Depth	28.5	Seat Depth	19.5	Arm Height	25.5
Height	33.25	Seat Height	18.25	Weight	87
COM	3.5 YDS				

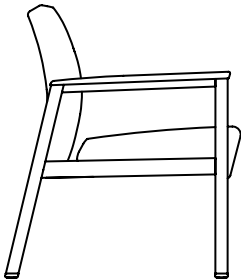

**PRICING WITH URETHANE ARM CAPS - KAM20IBRU**

COM	4	5	6	7	8	9	10	11
2559	2579	2659	2739	2829	2939	3079	3169	3349

**PRICING WITH WOOD ARM CAPS - KAM20IBRW**

COM	4	5	6	7	8	9	10	11
2559	2579	2659	2739	2829	2939	3079	3169	3349

**PRICING WITH SOLID SURFACE ARM CAPS - KAM20IBRJ**

COM	4	5	6	7	8	9	10	11
3359	3379	3439	3529	3619	3729	3859	3939	4109

**TO ORDER, SPECIFY**

- 1. Model Number                      3. Finish
- 2. Textile                                4. Options

**KAM30I - 3 SEAT GUEST CHAIR WITH ARM CAPS, INTERVENING ARM**

**DIMENSIONS**

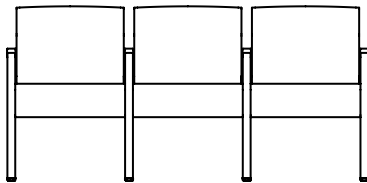

Width	69.5	Seat Width	20.75	Back Height	15
Depth	28.5	Seat Depth	19.5	Arm Height	25.5
Height	33.25	Seat Height	18.25	Weight	120
COM	4.5 YDS				

**PRICING WITH URETHANE ARM CAPS - KAM30IU**

COM	4	5	6	7	8	9	10	11
3009	3049	3169	3249	3369	3529	3719	3779	4059

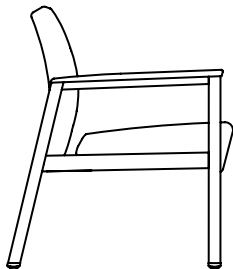

**PRICING WITH WOOD ARM CAPS - KAM30IW**

COM	4	5	6	7	8	9	10	11
3009	3049	3169	3249	3369	3529	3719	3779	4059

**PRICING WITH SOLID SURFACE ARM CAPS - KAM30IJ**

COM	4	5	6	7	8	9	10	11
4079	4109	4219	4299	4419	4579	4769	4809	5069

**KAM30IBC - 3 SEAT GUEST CHAIR WITH ARM CAPS, 29.5" CENTER BARIATRIC, INTERVENING ARM**

**DIMENSIONS**

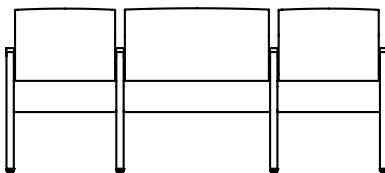

Width	80.5	Seat Width	29.5	Back Height	15
Depth	28.5	Seat Depth	19.5	Arm Height	25.5
Height	33.25	Seat Height	18.25	Weight	127
COM	4.5 YDS				

**PRICING WITH URETHANE ARM CAPS - KAM30IBCU**

COM	4	5	6	7	8	9	10	11
3479	3529	3659	3769	3949	4119	4249	4379	4459

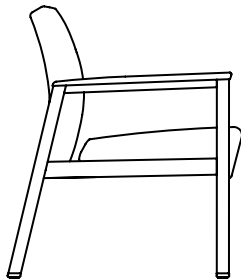

**PRICING WITH WOOD ARM CAPS - KAM30IBCW**

COM	4	5	6	7	8	9	10	11
3479	3529	3659	3769	3949	4119	4249	4379	4459

**PRICING WITH SOLID SURFACE ARM CAPS - KAM30IB CJ**

COM	4	5	6	7	8	9	10	11
4559	4589	4709	4819	4999	5169	5299	5399	5469

**TO ORDER, SPECIFY**

- 1. Model Number
- 2. Textile
- 3. Finish
- 4. Options

**KAM30IBL - 3 SEAT GUEST CHAIR WITH ARM CAPS, 29.5" LEFT FACING BARIATRIC, INTERVENING ARM**

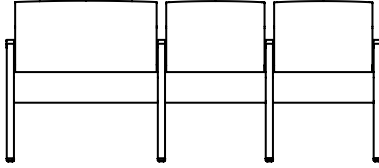

**DIMENSIONS**

Width	80.5	Seat Width	29.5	Back Height	15
Depth	28.5	Seat Depth	19.5	Arm Height	25.5
Height	33.25	Seat Height	18.25	Weight	127
COM	4.5 YDS				

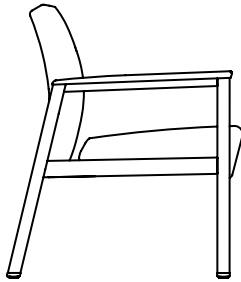

**PRICING WITH URETHANE ARM CAPS - KAM30IBLU**

COM	4	5	6	7	8	9	10	11
3479	3529	3659	3769	3949	4119	4249	4379	4459

**PRICING WITH WOOD ARM CAPS - KAM30IBLW**

COM	4	5	6	7	8	9	10	11
3479	3529	3659	3769	3949	4119	4249	4379	4459

**PRICING WITH SOLID SURFACE ARM CAPS - KAM30IBLJ**

COM	4	5	6	7	8	9	10	11
4559	4589	4709	4819	4999	5169	5299	5399	5469

**KAM30IBR - 3 SEAT GUEST CHAIR WITH ARM CAPS, 29.5" RIGHT FACING BARIATRIC, INTERVENING ARM**

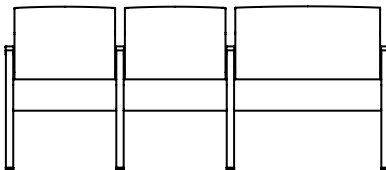

**DIMENSIONS**

Width	80.5	Seat Width	29.5	Back Height	15
Depth	28.5	Seat Depth	19.5	Arm Height	25.5
Height	33.25	Seat Height	18.25	Weight	127
COM	4.5 YDS				

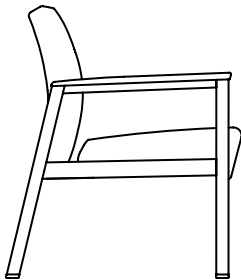

**PRICING WITH URETHANE ARM CAPS - KAM30IBRU**

COM	4	5	6	7	8	9	10	11
3479	3529	3659	3769	3949	4119	4249	4379	4459

**PRICING WITH WOOD ARM CAPS - KAM30IBRW**

COM	4	5	6	7	8	9	10	11
3479	3529	3659	3769	3949	4119	4249	4379	4459

**PRICING WITH SOLID SURFACE ARM CAPS - KAM30IBRJ**

COM	4	5	6	7	8	9	10	11
4559	4589	4709	4819	4999	5169	5299	5399	5469

**TO ORDER, SPECIFY**

- 1. Model Number      3. Finish
- 2. Textile             4. Options

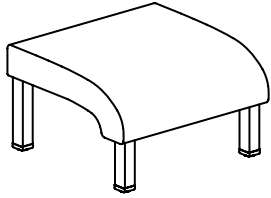

**KOT00 - OTTOMAN**

**COM IS IN YARDS**

COM	4	5	6	7	8	9	10	11
799	809	849	879	909	959	1009	1039	1059

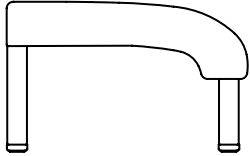

W	D	H	Weight	COM
19	18.5	12	12.1	1



**TO ORDER, SPECIFY**

- 1. Model Number      3. Finish
- 2. Textile              4. Options

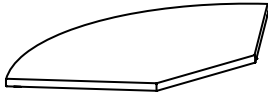

**KTC07 - CORNER GANGING TABLE**

**DIMENSIONS**

Width	69.5	Depth	29.5	Height	33.5
Weight	32				

**LIST PRICE - 989**

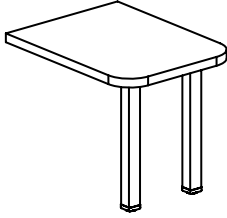

**KTE07L - LEFT END GANGING TABLE (FACING)**

**DIMENSIONS**

Width	15.5	Depth	20	Height	15
Weight	19				

**LIST PRICE - 799**

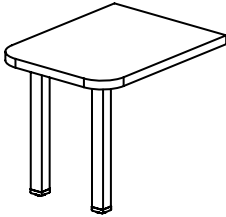

**KTE07R - RIGHT END GANGING TABLE (FACING)**

**DIMENSIONS**

Width	15.5	Depth	20	Height	15
Weight	19				

**LIST PRICE - 799**

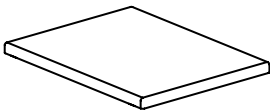

**KTI07 - INTERVENING GANGING TABLE**

**DIMENSIONS**

Width	19	Depth	20	Height	15
Weight	17				

**LIST PRICE - 689**

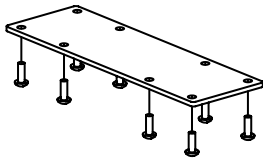

**GANG BRKT KOT - GANGING BRACKET (TO GANG CHAIRS TOGETHER)**

**DIMENSIONS**

Width	11	Depth	.25	Height	3.5
Weight	2				

**LIST PRICE - 79**



**PT - TABLE UNDERMOUNT POWER**

**DIMENSIONS**

Width	9	Depth	1.85	Height	2.25
-------	---	-------	------	--------	------

**LIST PRICE - 239**