

Custom design your own sleeper with our variety of options

Combining our legacy of comfort with the Durability and Performance needed for Healthcare

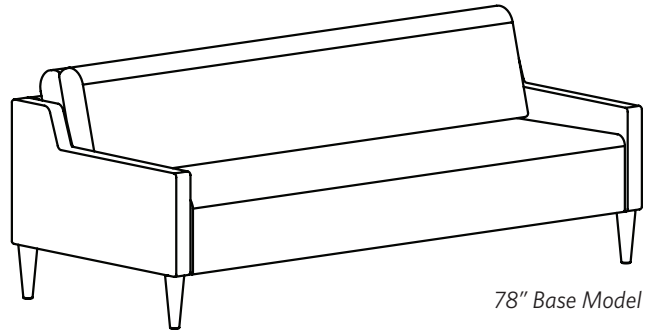

78" Base Model

DIMENSIONS

Kenzley Sleep Sofa Base Models

K7833 - 78" SEAT WIDTH MODEL

Width: 84"	Seat Width: 77"	Back Height: 15"
Depth: 35.5"	Seat Depth: 21.5"	Arm Height: 24.75"
Height: 32"	Seat Height: 17.75"	Weight: 175 lbs.

K7033 - 70" SEAT WIDTH MODEL*

Width: 76.5"	Seat Width: 69.5"	Back Height: 15"
Depth: 35.5"	Seat Depth: 21.5"	Arm Height: 24.75"
Height: 32"	Seat Height: 17.75"	Weight: 173 lbs.

FEATURES

Standard Features

- 70" or 78" Seat Width
- Upholstered Arms
- Wood Tapered Legs
- 3.5" Arms (+7" to overall width)

OTHER OPTIONS

- 5" Arms (+10" to overall width)
- 6" Lounge Arms (+12" to overall width)
- 3.5" Caster Arms (+7" to overall width)
- Thermofoil Arm Caps
- Urethane Arm Caps
- Solid Surface Arm Caps
- Metal Legs
- Tapered Metal Legs
- Moisture Barrier Back
- Moisture Barrier Seat
- CAL TB133
- Multi-Cover
- Casters (with 3.5" Caster Arms)
- USB Hospital Grade Power

Visual Option Guide

This page illustrates the choices available to customize the Kenzley Sleep Sofa to your specific needs. The following pages include pricing and a table to guide you in building a product model number based on your selected specifications.

The Kenzley Sleep Sofa is available in two (2) standard seat widths: 78" and 70".

LEG OPTIONS

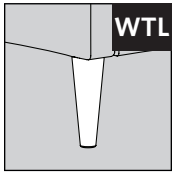

Wood Tapered Leg

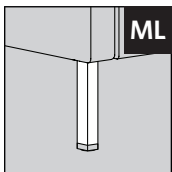

Metal Leg

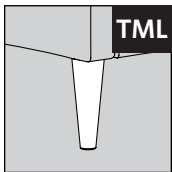

Tapered Metal Leg

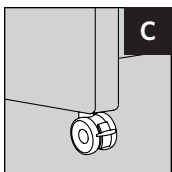

3" Swivel Locking Casters*

*Available on 3.5" Wide Caster Arms (Full Height)

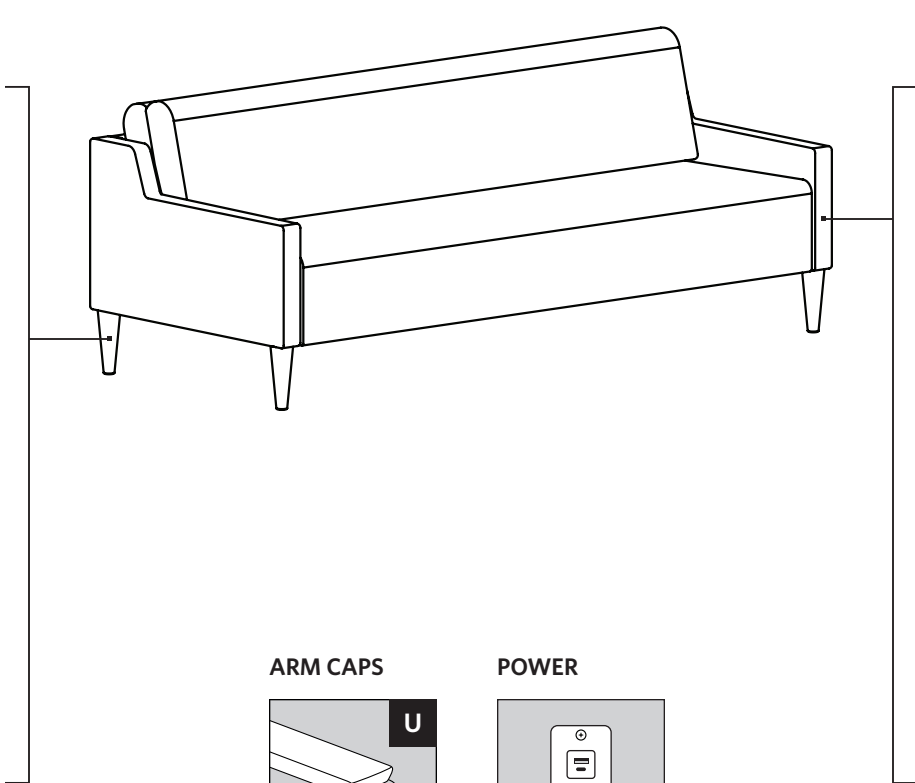

ARM STYLES

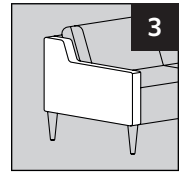

3.5" Wide Arms

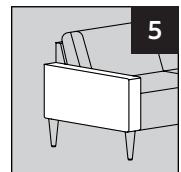

5" Wide Arms

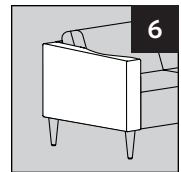

6" Wide Lounge Arms

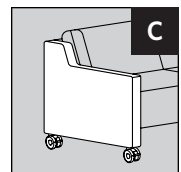

3.5" Wide Caster Arms (Full Height)

ARM CAPS

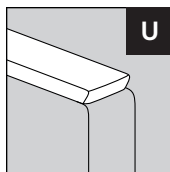

Urethane

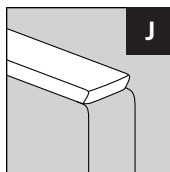

Solid Surface

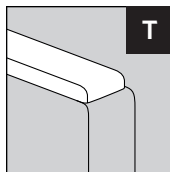

Thermofoil

POWER

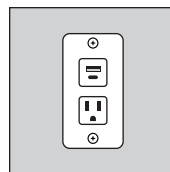

Hospital Grade Power

Base Model Pricing

Select base pricing below dependent on your selection of 78" seat width (K7833) or 70" seat width (K7033), and selected textile grade.

Base models are standard with upholstered 3.5" wide arms and wood tapered legs. Selections made on the following page will affect the model number, list price, and dimensions.

K7833 - 78" Seat Width Base Sofa with 3.5" Arms

Dimensions

Overall			Seat		
W	D	H	W	D	H
84	35.5	32	77	21.5	17.75
Sleep W	Sleep D	Back H	Arm H		
84	28.5	15	24.75		

COM: 9.4 yds
 Wt Cap: 900 lb
 Unit Weight: 175 lb

**Weight will vary based on selected options

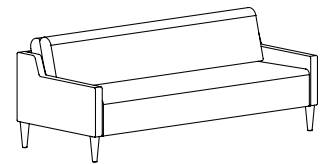

K7833
78" Base Sofa

Pricing

COM	Dillon/Carson	A ₅	B ₆	C ₇	D ₈	E ₉	F ₁₀	G ₁₁	H ₁₂	I ₁₃
5,989	6,299	6,559	6,859	7,109	7,469	7,669	7,939	8,379	8,739	9,079

K7033 - 70" Seat Width Base Sofa with 3.5" Arms

Dimensions

Overall			Seat		
W	D	H	W	D	H
76.5	35.5	32	69.5	21.5	17.75
Sleep W	Sleep D	Back H	Arm H		
76.5	28.5	15	24.75		

COM: 9.2 yds
 Wt Cap: 900 lb
 Unit Weight: 173 lb

**Weight will vary based on selected options

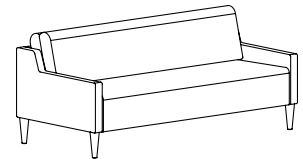

K7033
70" Base Sofa

Pricing

COM	Dillon/Carson	A ₅	B ₆	C ₇	D ₈	E ₉	F ₁₀	G ₁₁	H ₁₂	I ₁₃
5,829	6,139	6,399	6,689	6,939	7,299	7,509	7,779	8,229	8,589	8,939

For COM orders, add the below yardage for options selected.

Lounge Arms (pair): +0.4 yds
 Caster Arms (each): +0.6 yds

KZE07R - Right Side Facing Integrated Side Table with Thermofoil Top (for left facing table, use KZE07L)

Dimensions

Overall		
W	D	H
16	34.5	9

Unit Weight: 17.5 lb

Price
419

TABLE LEG OPTIONS

WTL	Wood Tapered Legs	Standard
ML	Metal Legs	149
TML	Tapered Metal Legs (Silver Frost finish ¹)	449

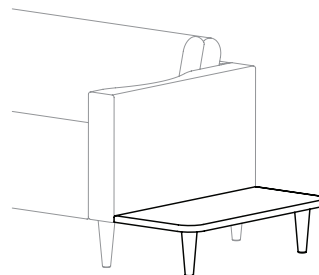

KZE07R
Right Facing Integrated Table
(for left facing table, use KZE07L)

¹Additional metal finishes are available. Contact customer service for a quote.

Build Model Number by Selecting One Option from Each Column

Specify any additional options, along with textile/s and finishes. Add associated list prices from your selections below to the base model price on the previous page.

EXAMPLE

1. Family

All Kenzley models begin with **K**

K

Kenzley

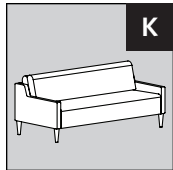

Kenzley

2. Seat Width

Choose from **78** or **70**

78

78" Seat Width

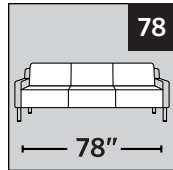

78" Seat Width
See base pricing on previous page

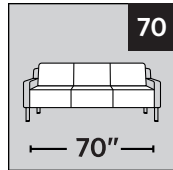

70" Seat Width
See base pricing on previous page

3. Left Arm

Choose from **3** or **5** or **6**

3

3.5" Wide Arm

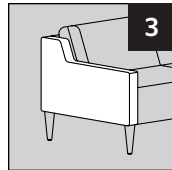

3.5" Wide Arm

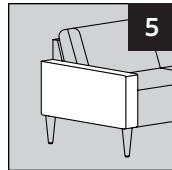

5" Wide Arm
Single Arm +100

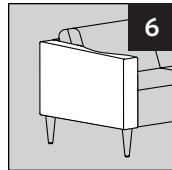

Lounge Arm (6")⁴
Single Arm +250

4. Right Arm

Choose from **3** or **5** or **6**

3

3.5" Wide Arm

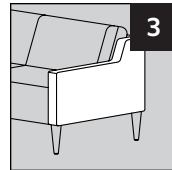

3.5" Wide Arm

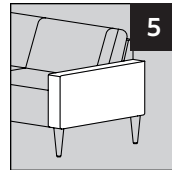

5" Wide Arm
Single Arm +100

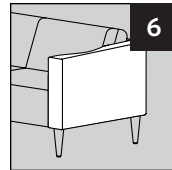

Lounge Arm (6")⁴
Single Arm +250

5. Casters

Optional **C**

C

Casters

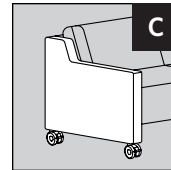

Caster Arms
+369

Must select 3.5" Wide Arm on left and right side. Arms with casters are full height.

Available Options

ARM CAP OPTIONS³

See pg 2 for finishes

	3.5" Arms	5" Arms
U Urethane	209	259
J1 Solid Surface - Group 1	619	1239
J2 Solid Surface - Group 2	819	1439
T Thermofoil	139	229
F Fully Upholstered Arms	Standard	Standard

LEG OPTIONS

WTL Wood Tapered Legs	Standard
ML Metal Legs	279
TML Tapered Metal Legs (Silver Frost finish ¹)	949
C Casters (See table above for availability)	369

ADDITIONAL FEATURES & OPTIONS

POWER	Hospital Grade Power Outlet ²	569
CAL	CAL TB133	See pg 9
Z	Multi Cover	Use Pricing for Highest Grade
MB	Moisture Barrier	See pg 11

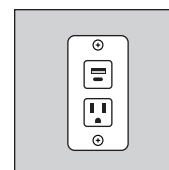

Power Placement:

If 3.5" Left Arm selected- front of raised back arm

If 5" or 6" Left Arm selected- front of left (facing) arm

¹Additional metal finishes are available. Contact customer service for a quote.

²(2) USB Ports, (1) 120 V Power Outlet

³Arm caps not available on Lounge style arms

⁴Due to arm contour, textiles with 2-way repeat will not match on lounge arm

MULTI-COVER FORM - KENZLEY SLEEP SOFA

Dealer | Design Firm: _____

Project: _____

Model #: _____

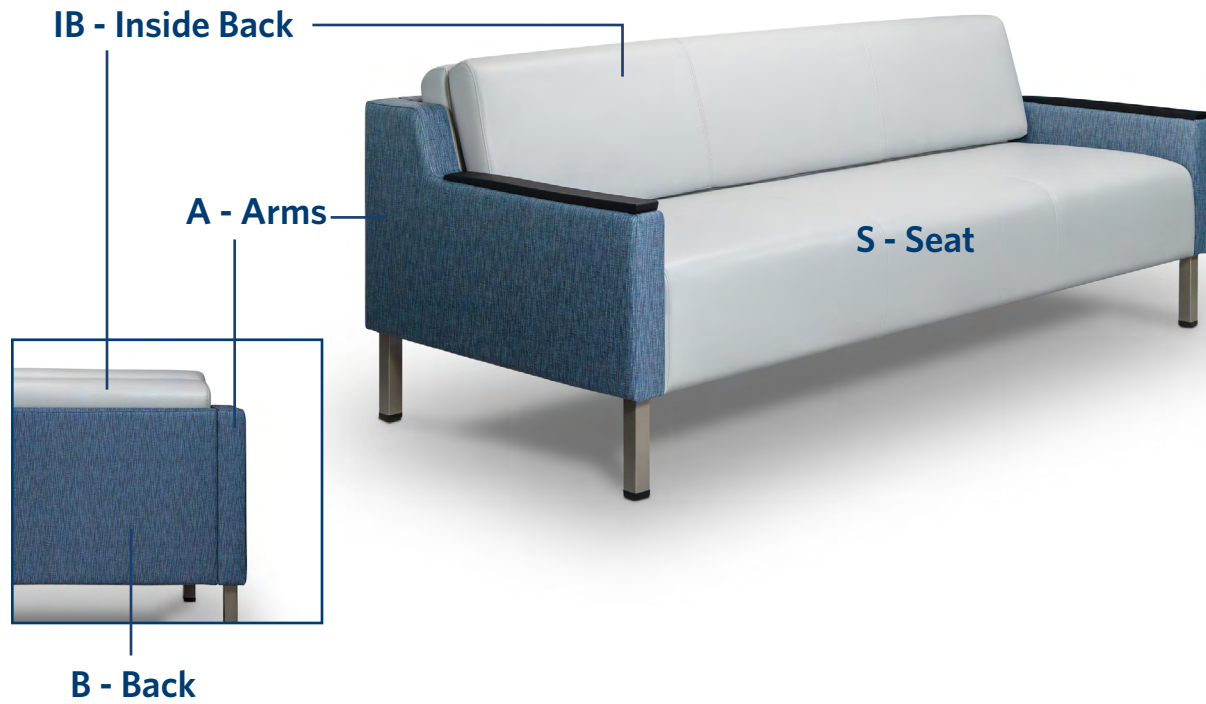

LOCATION	ID	FABRIC SUPPLIER	PATTERN	COLORWAY
Arms	A			
Back	B			
Seat	S			
Inside Back	IB			